

视频 计算机 系统



你今天拼搭雅达利了吗？

雅达利视频计算机系统 (VCS) 于 1977 年问世, 将街机游戏逼真和激动人心的特性带入千家万户, 其拥有高达 3000 万台的销量, 并将继续成为历史上最受欢迎的游戏系统之一。这款乐高®版本的雅达利视频计算机系统源自 1980 年的标志性四开关 CX-2600A, 充满了逼真的细节和彩蛋, 可将你带回经典游戏盛行的年代。祝你拼搭和玩乐愉快!

游戏机经典

听起来令人难以置信的是, 四开关 CX-2600A 将于 2022 年庆祝其推出 42 周年。CX-2600A 是雅达利视频计算机系统最受欢迎的版本, 它为当时的主机游戏设定了标准, 时至今日依然是雅达利今天所有复古游戏机设计的起点。





HAVE YOU PLAYED ATARI TODAY?

ATARI 50



50 年游戏历程

雅达利成立于 1972 年，至今仍是游戏界最具标志性的品牌之一。半个多世纪后，该品牌继续与粉丝和那些寻求复古游戏快感的人们产生共鸣。雅达利曾出现在无数的电视节目、电影和流行文化中，成为了一个真正的文化标的，远远超出了电脑游戏本身。



← 卡带系统允许玩家沉浸于多种不同的游戏

↓ 雅达利视频计算机系统广告

ATARI



THERE'S NO COMPARING IT WITH ANY OTHER VIDEO GAME.

Only ATARI makes the games the world wants most. Games that are innovative. Intense. Incredibly involving. And totally original.

The most games, the best games are only from ATARI. Atari makes more video game cartridges than anyone else.

Today ATARI Missile Command and Asteroids are the fastest selling home video games in the country.

NIGHT DRIVER	▲
SLOT RAKERS	▲
RYSTERICIDS	▲
BACKGAMMON	▲
HEMMY CHECKERBALL	▲
LUARLORDS	▲
CARICOM FOMBER	▲
BASKETBALL	▲
RACE	▲
HOME RUN	▲
STREET RACER	▲
ADVENTURE	▲
WRESTLING	▲
WRESTLING	▲
CONCENTRATION	▲
LODGEBREAKER	▲
SOLO	▲
CASINO	▲
BLACKJACK	▲
FOOTBALL	▲
SKY DIVER	▲
ASTEROIDS	▲
HAWKMAN	▲
BRILLIANT GAMES	▲
VIDEO PINBALL	▲
BOWLING	▲
AGENT X	▲
VIDEO GESS	▲
CIRCLE SHOOT	▲
DODGE 'EM	▲
WRESTLING	▲
VIDEO CHECKERS	▲
ARCADE BATTLE	▲
COMBAT	▲
SUBRACTORS	▲





更多游戏 更多乐趣

与众多仅提供单一集成游戏的早期游戏系统不同，雅达利所采用的卡带系统几乎拥有无数种游戏选择。雅达利视频计算机系统共发布了 527 款游戏，《爆破彗星》、《吃豆人》、《陷阱》等热门游戏在 70 年代末和 80 年代初确立了其必备游戏系统的地位。



1980 年 **魔幻历险**

这款游戏激发了一整代渴望冒险的人们的热情。在游戏中，邪恶的巫师偷走了城堡中的魔法圣杯，你必须带领勇敢的骑士克服一系列可怕的危险，把它安全带回！



1981 年 **爆破彗星**

这款游戏最令人上瘾的地方是通过击落一波波彗星、卫星和不明飞行物来获得最高积分。彗星一旦被击中，就会分裂成更小、更快的碎片，朝着不可预测的方向飞走！

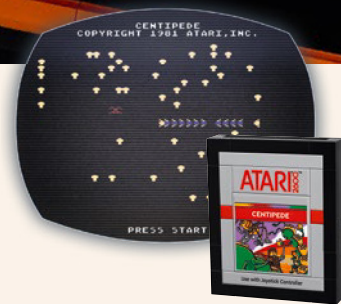

1982 年 **飞天蜈蚣**

这款游戏需要使用屏幕底部的魔杖尽可能多地消灭虫子。你的克星是一条弯弯曲曲的长蜈蚣，它会侵入每个关卡。如想完成游戏，你就必须消灭每个关卡中蜈蚣的每一段！

拼搭经典

这款乐高®模型包含 2532 块组件，以接近 1:1 的比例展现了标志性的四开关雅达利视频计算机系统（型号 CX-2600A），它除了插入游戏主机背面的复刻版摇杆外，还有前面的四个功能开关。本套装

还提供了三款著名 VCS 游戏的卡带，每款游戏都由一个可拼搭的乐高场景来展现，呈现了引人入胜的游戏体验。所有游戏卡带在不使用时都可以存放在很酷的 80 年代风格的卡带支架中！



前面板



后面板

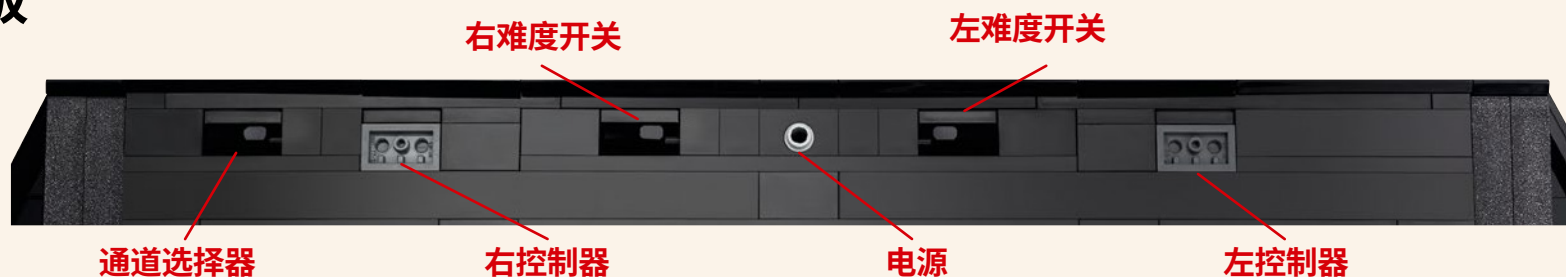

雅达利视频计算机系统

1977 年至 1992 年期间，雅达利推出了各种版本的视频计算机系统，主要通过重量、开关数量或游戏主机的外形装饰来区分。以今天的眼光来看，这项技术确实令人不敢恭

维，处理器速度仅有 1.19 MHz，RAM 为 128 字节，游戏卡带容量为 4 KB，然而在当时却是高端配置，风靡一时！

设计团队感言

对于一位经典主机游戏的铁杆粉丝和原创雅达利视频计算机系统的骄傲拥有者而言,能够在雅达利成立 50 周年之际参与这个项目算是梦想成真!一旦我们决定了模型的整体尺寸和功能,剩余的工作就是让小细节恰到好处:设计可以上下切换的开关,搭建一个在

外观和感觉上都酷似原始摇杆的模型,以及使用积木创造主机正面的经典木纹。当然,我们无法重现游戏本身,但我们决定引入三个可以拼搭的场景,让粉丝进一步感受这些经典游戏的玩乐体验。
乐高®设计师 Chris McVeigh

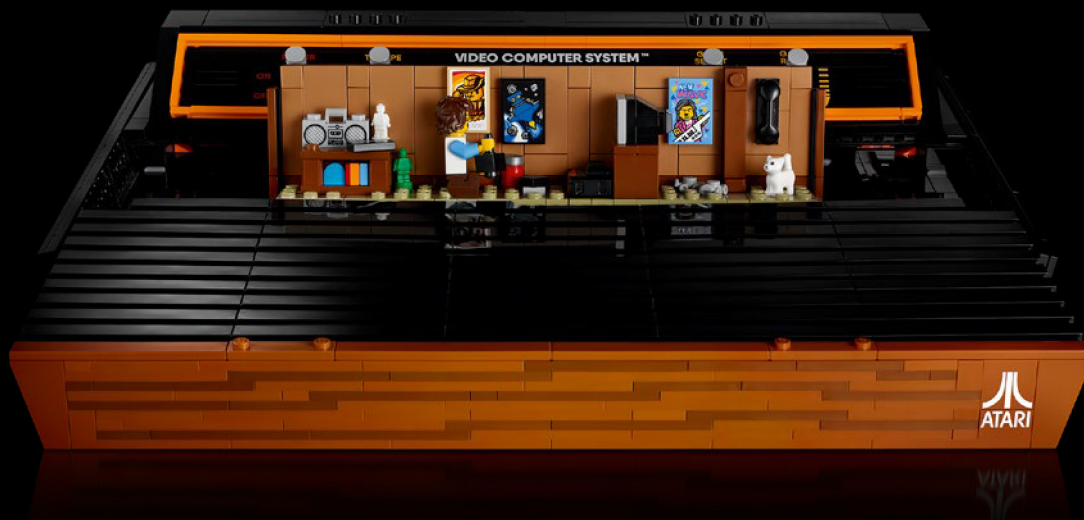

隐藏的弹出式场景充满怀旧细节,在 80 年代玩电子游戏长大的人们可以立即认出。



ATARI

AN ENTERTAINMENT WEEKLY COMPANY
BERKELEY, CA

CENTIPEDE

ADVENTURE

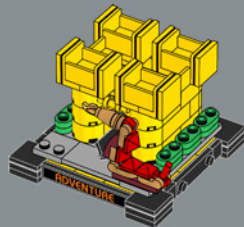
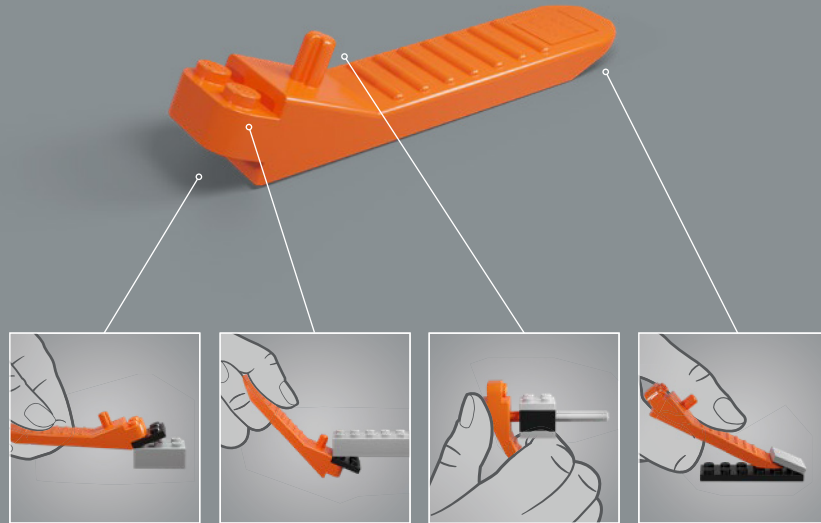

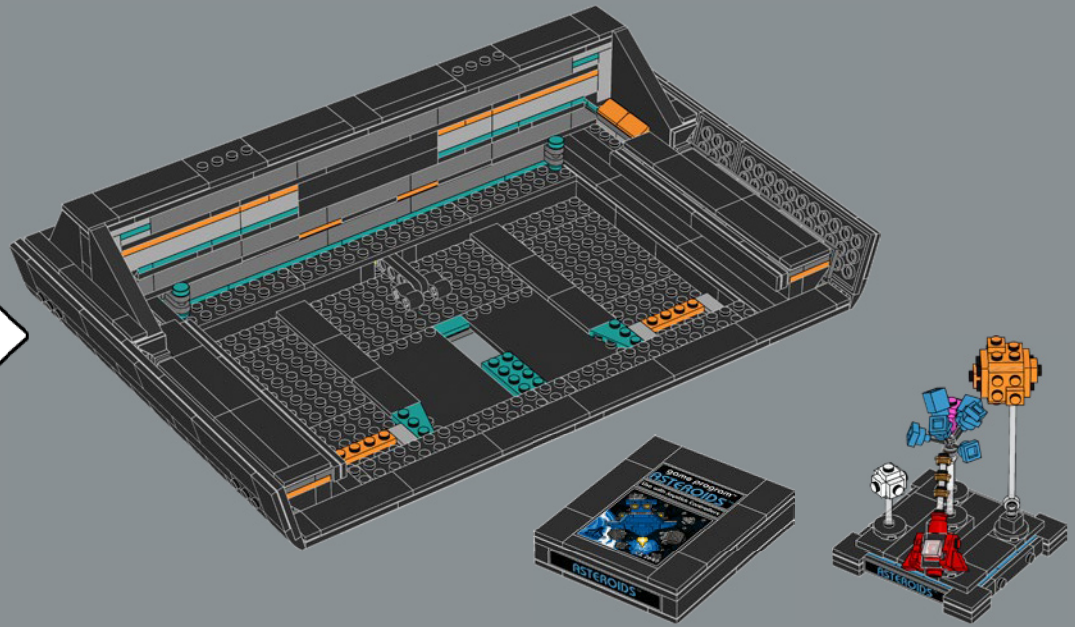

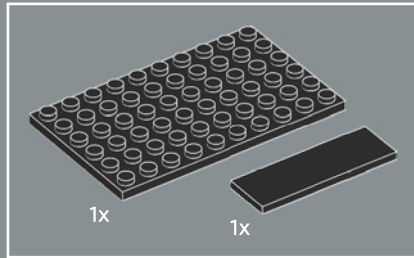
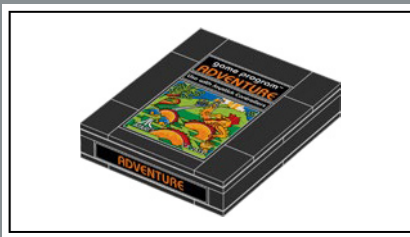

1

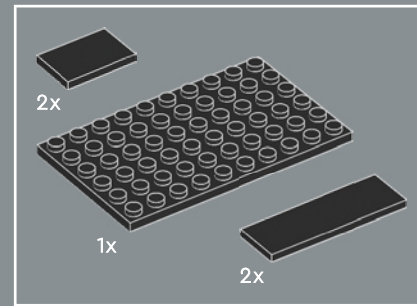
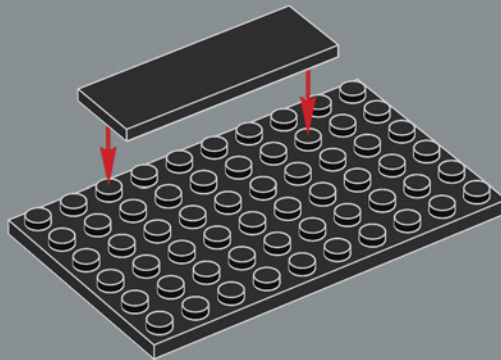

2

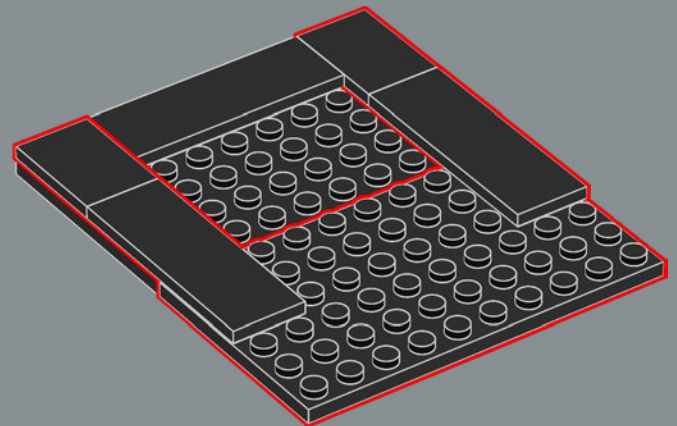

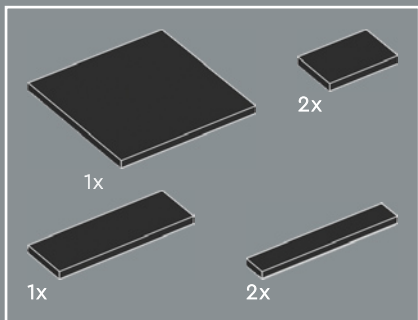

3

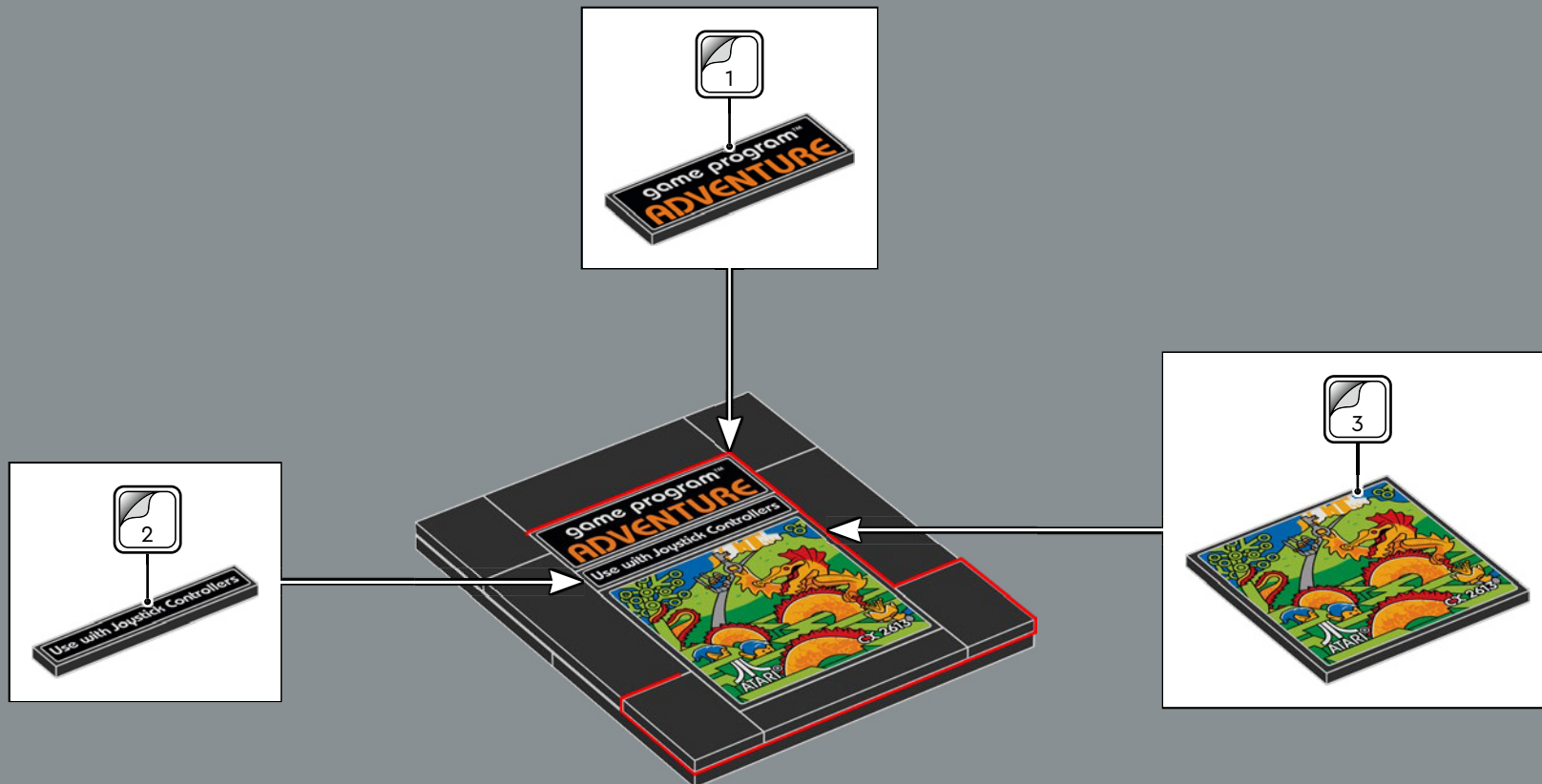

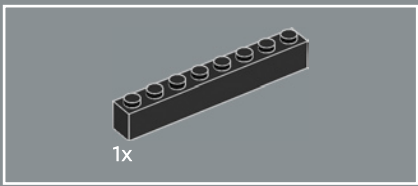

4

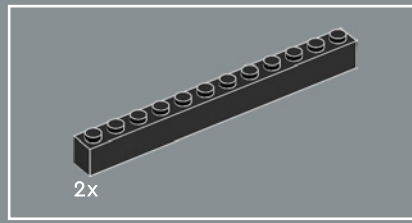
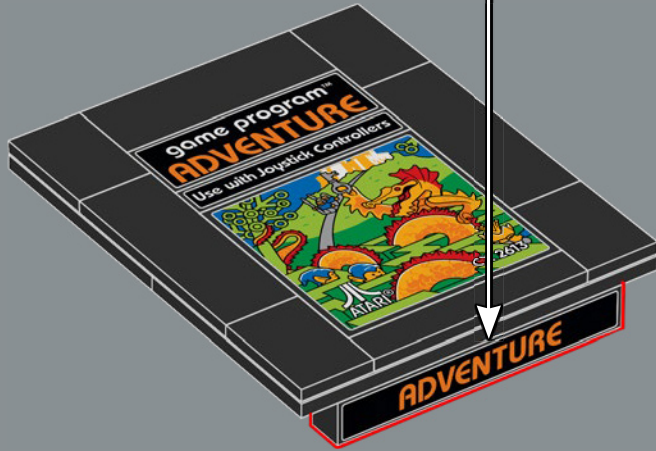
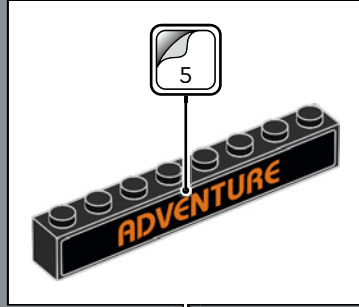

5

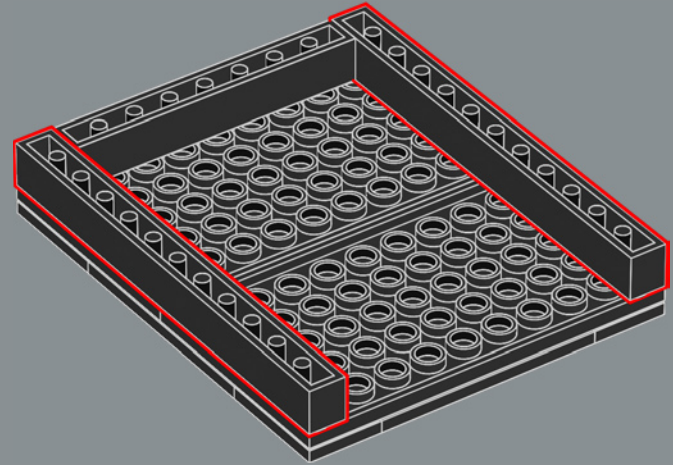

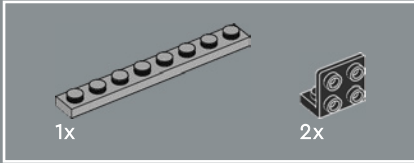
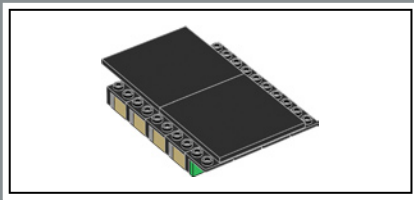

6

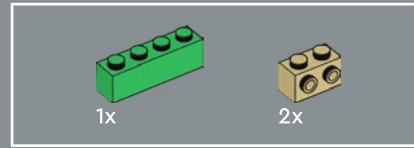
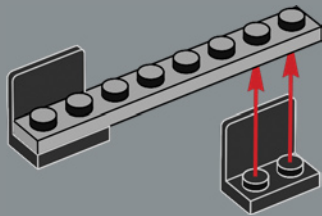

7

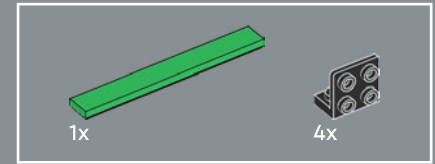
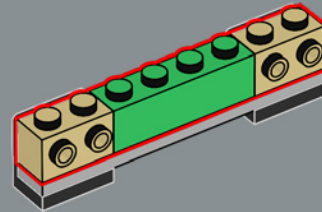

8

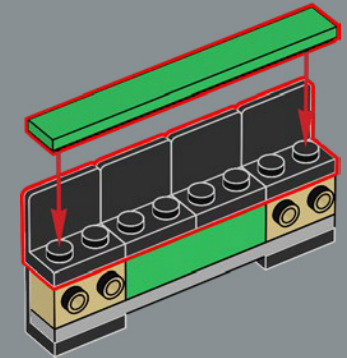

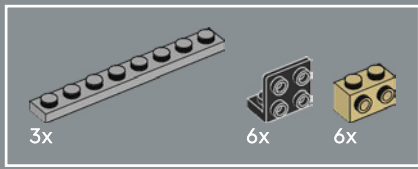

9

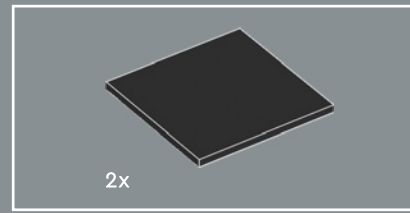
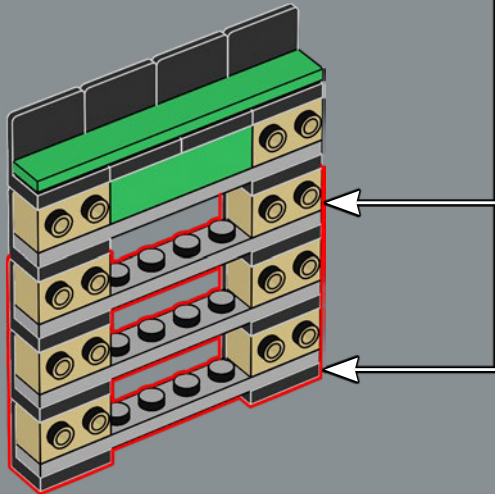
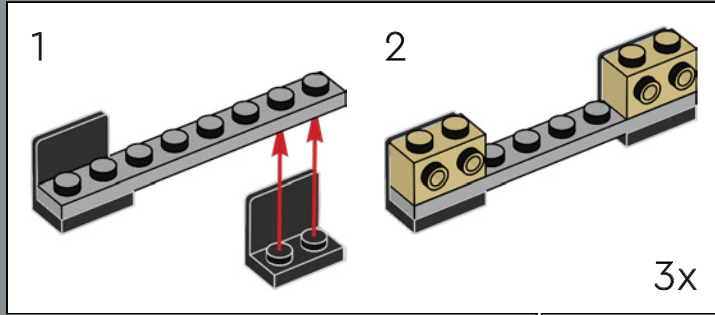

10

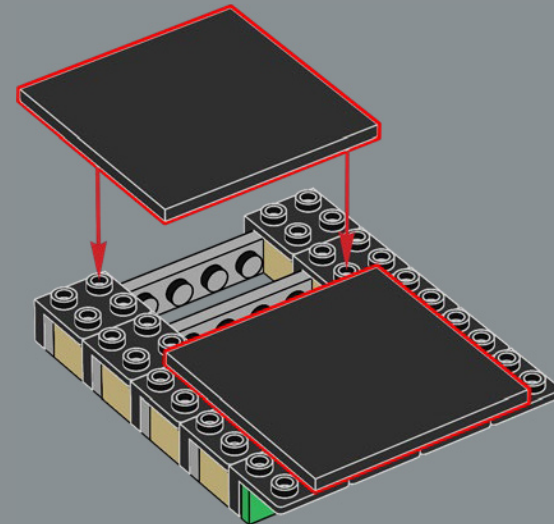

许多最早的雅达利视频计算机系统
游戏卡带仅使用 2k 数据, 这大致相
当于一页文本。



11

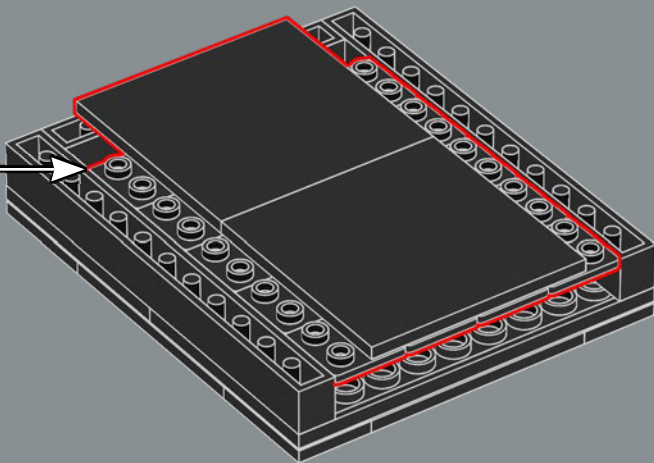

12

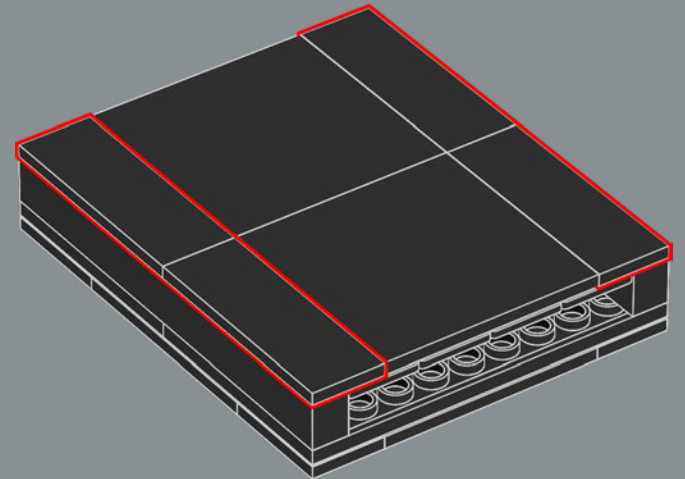
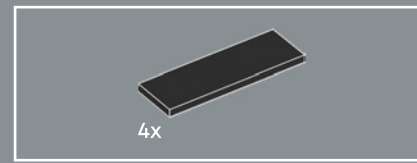

13



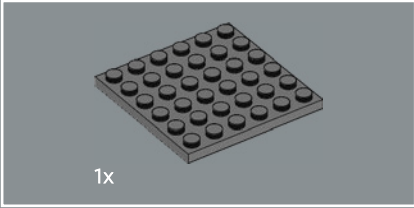
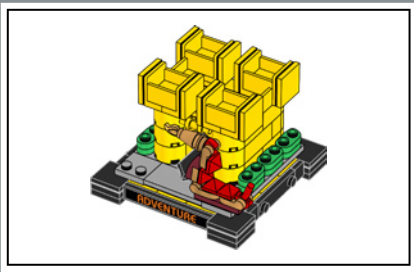

1

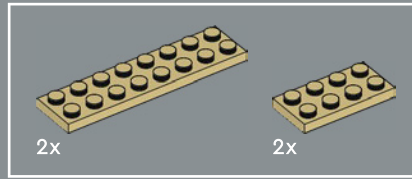
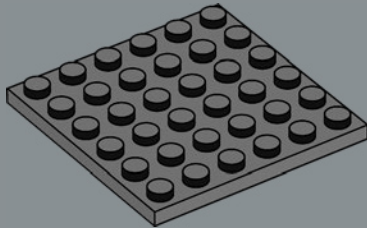

2

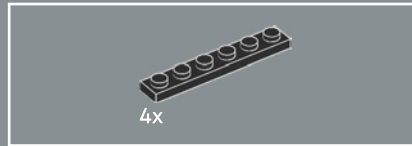
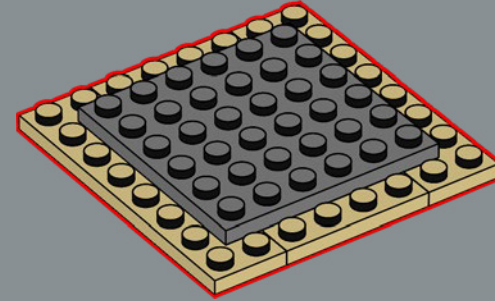

3

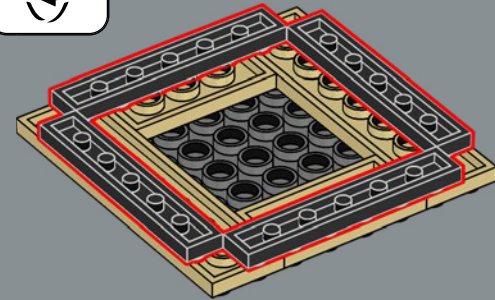

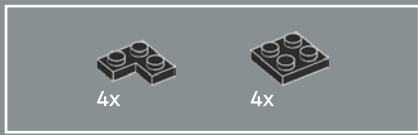

4

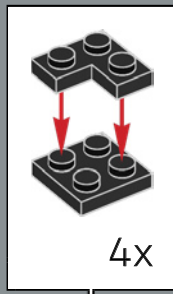
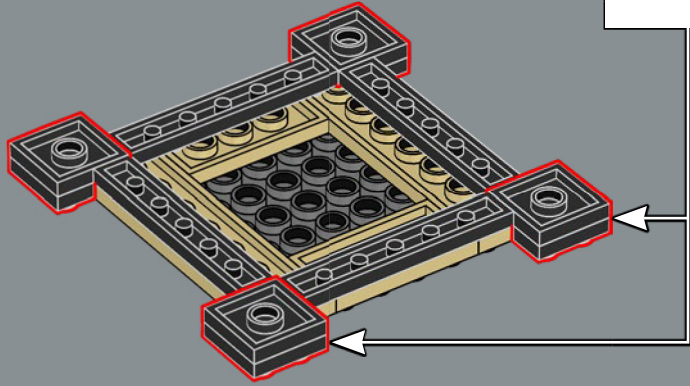

5

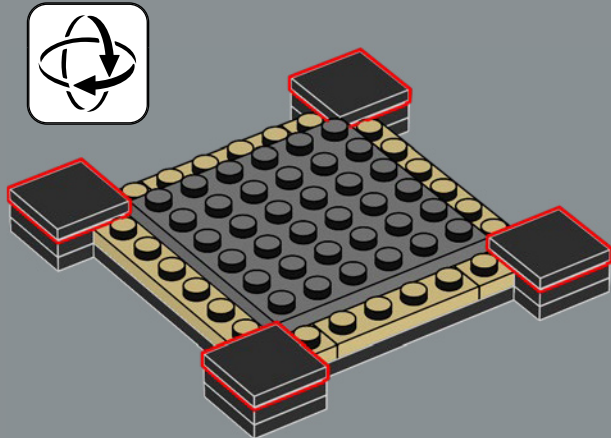

6

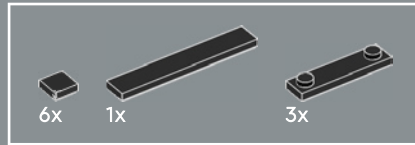
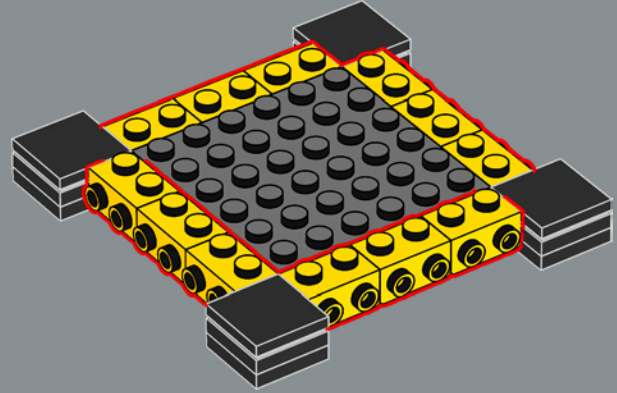

7

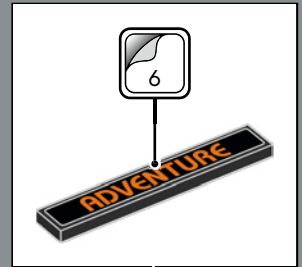
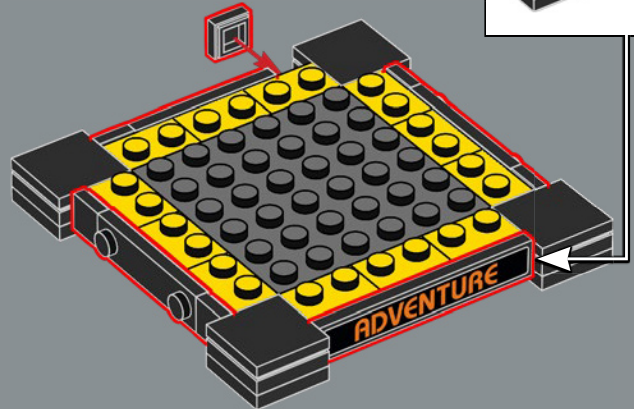

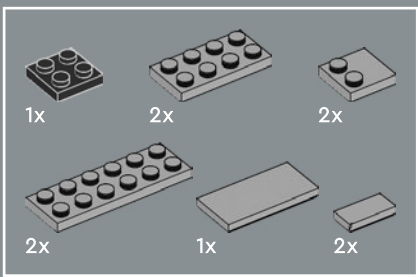

8

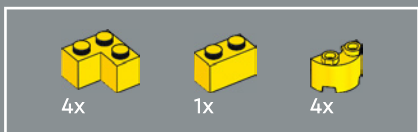
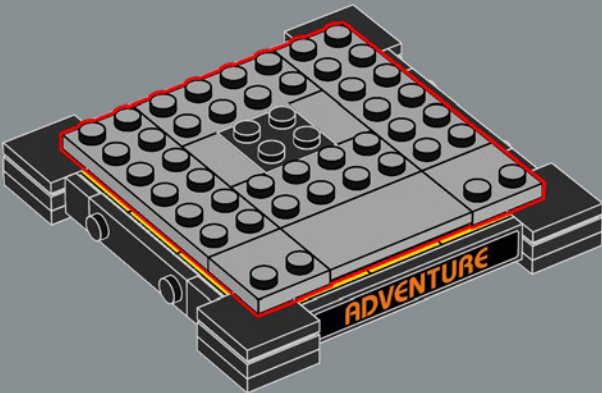

9

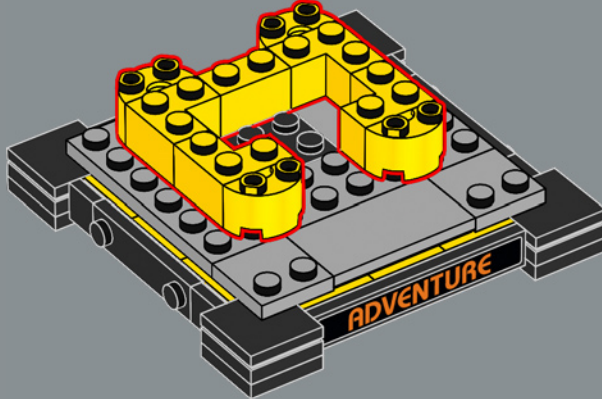

10

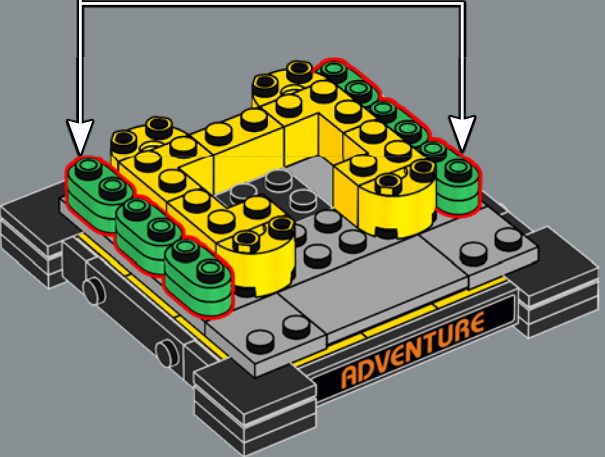
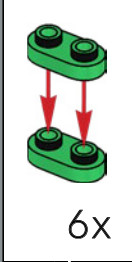



11

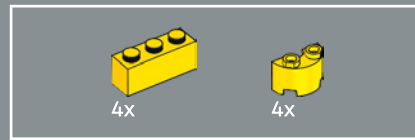
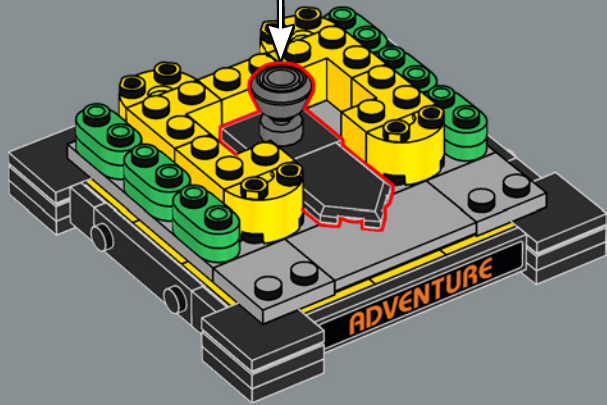
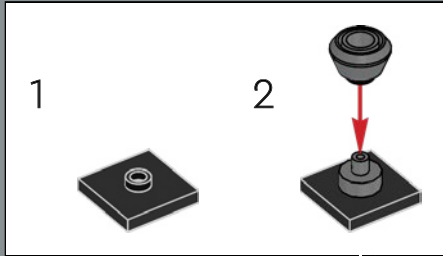

12

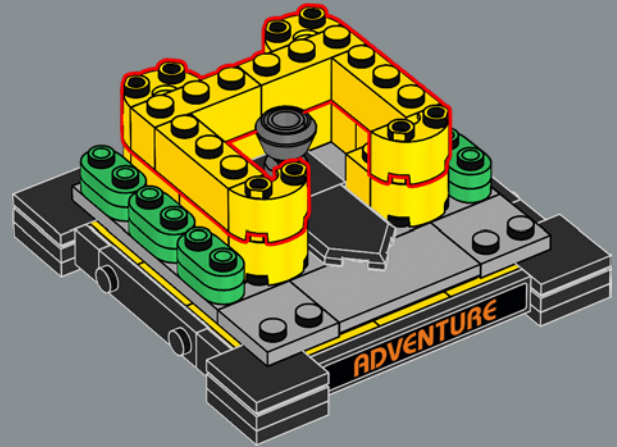

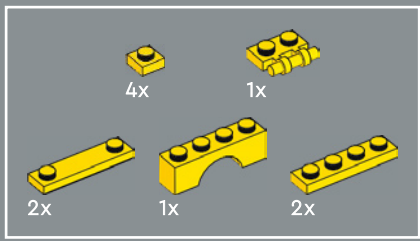

13

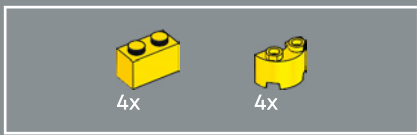
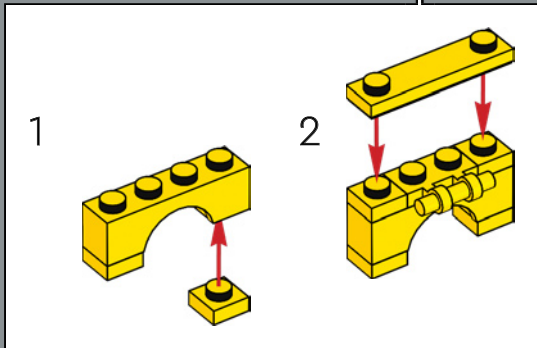
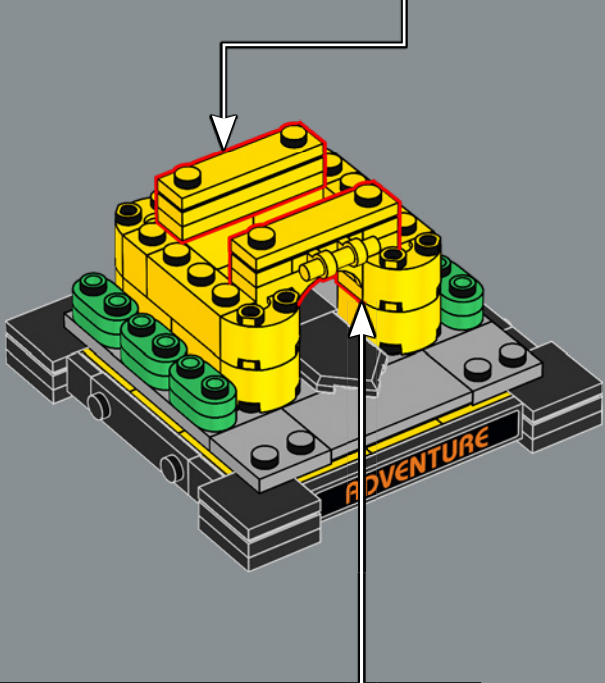
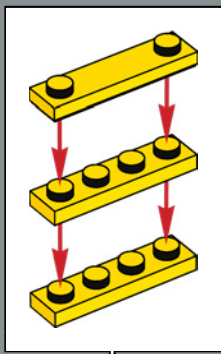

14

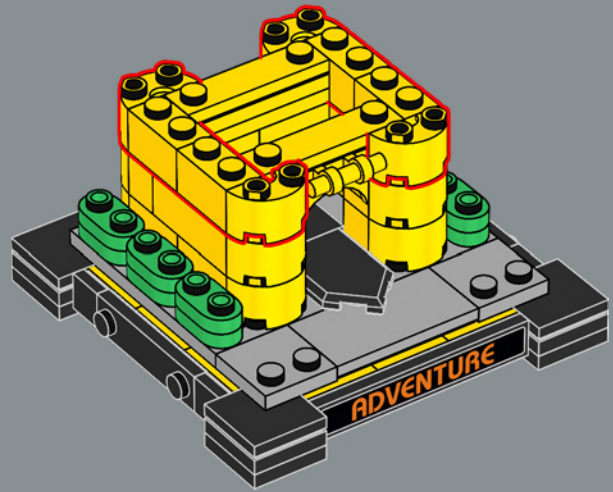

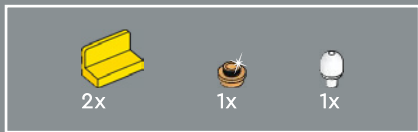

15

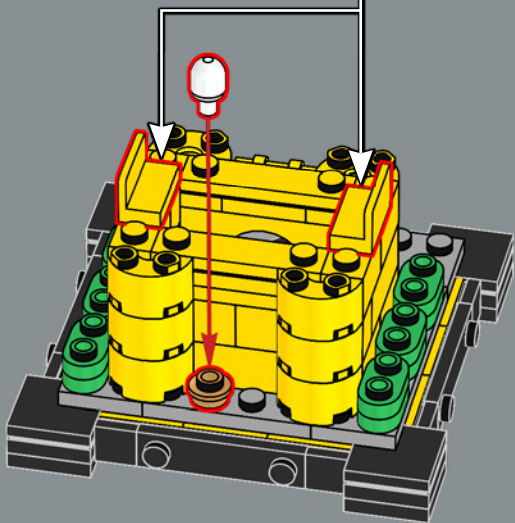
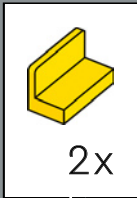

《魔幻历险》场景包括城堡后面一个带蛋的小鸟巢，这是对《魔幻历险》在电子游戏历史上首次引入复活节彩蛋这一事实致敬。

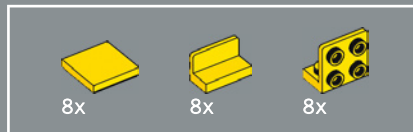

16

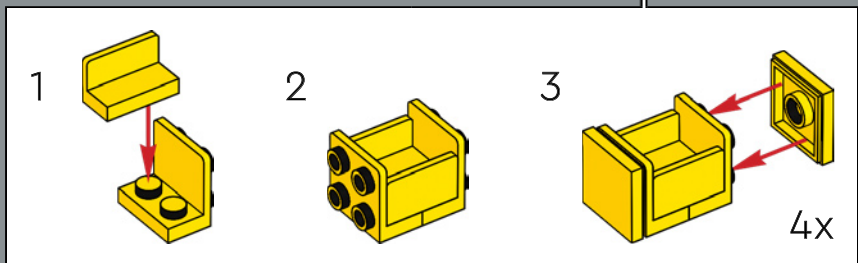
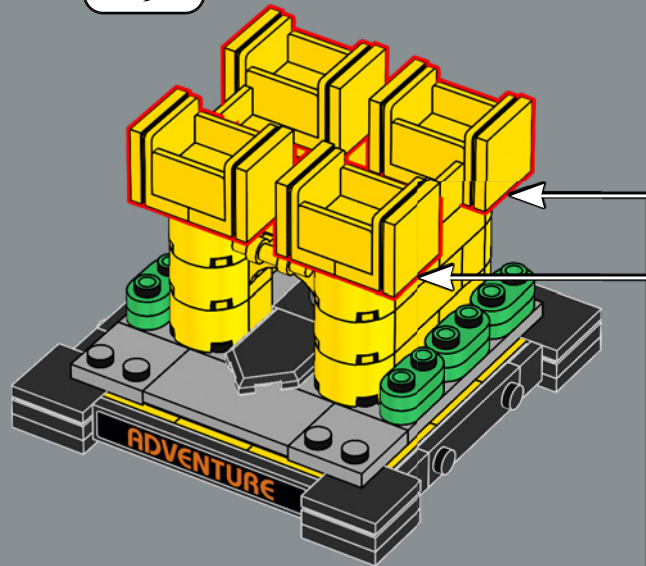

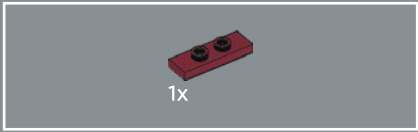

17

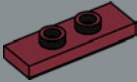

18

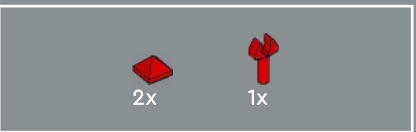

19

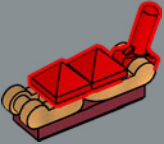

20

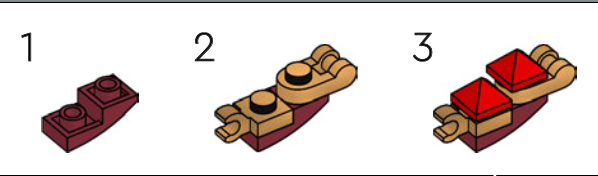



21

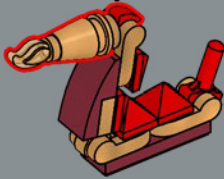
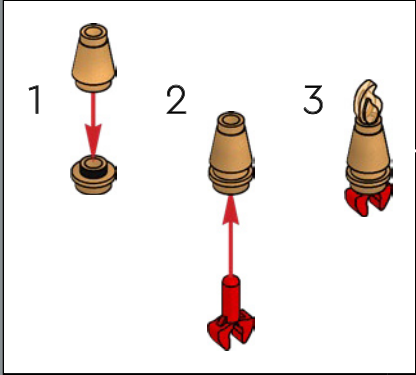

22

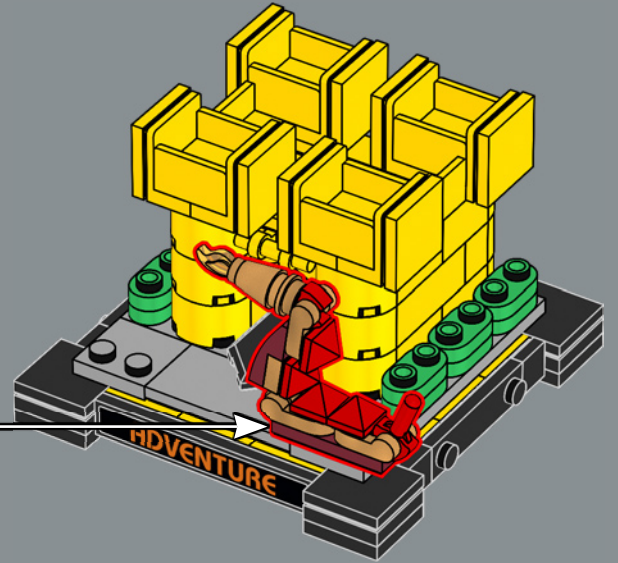

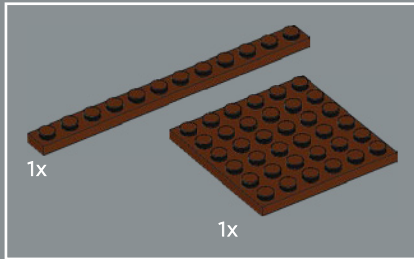
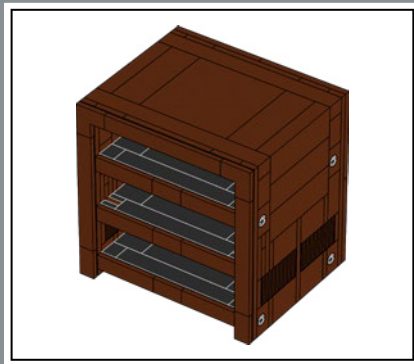

1

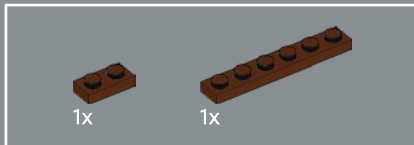
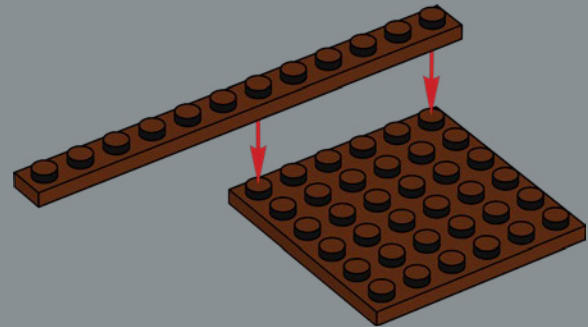

2

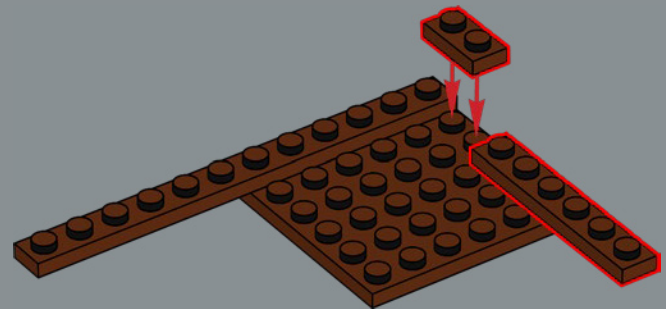

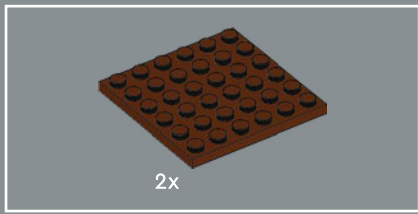

3

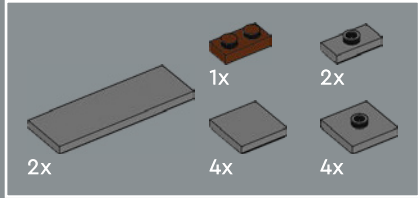
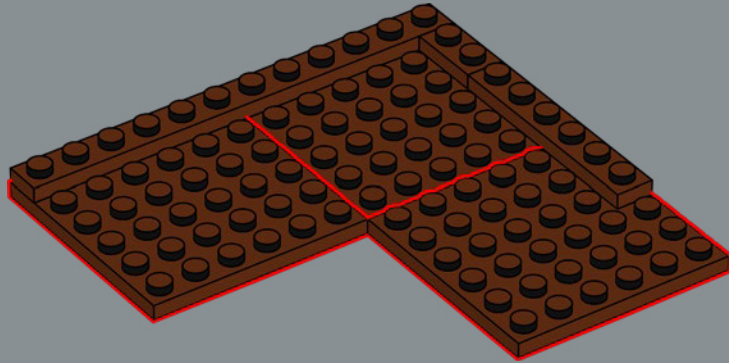

4

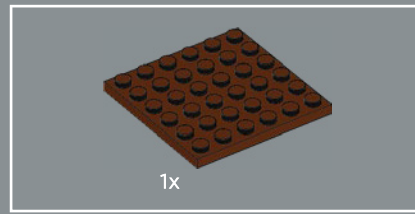
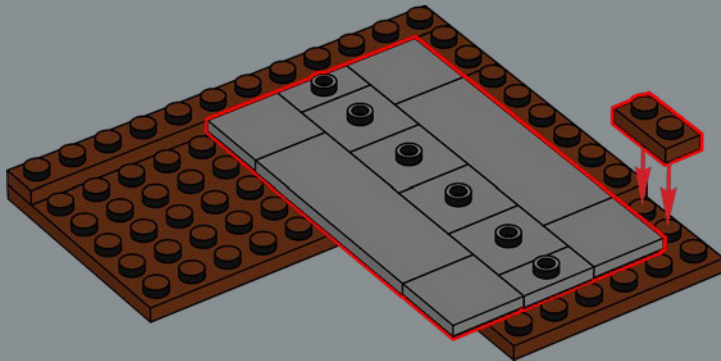

5

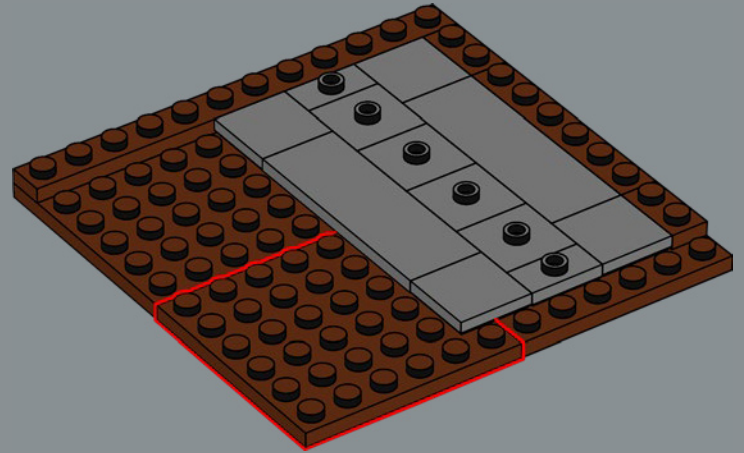

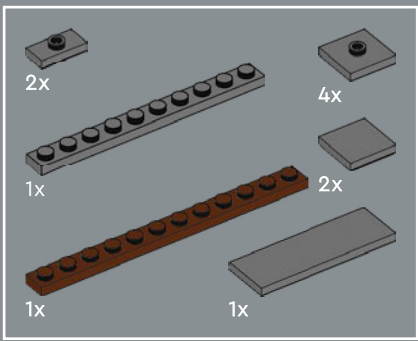

6

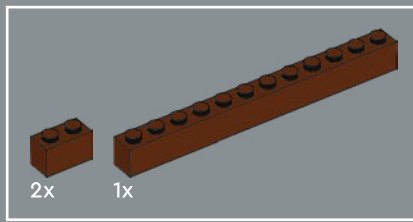
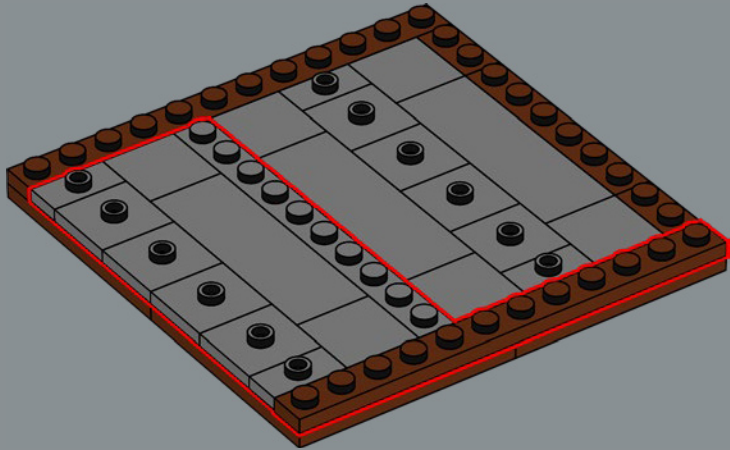

7

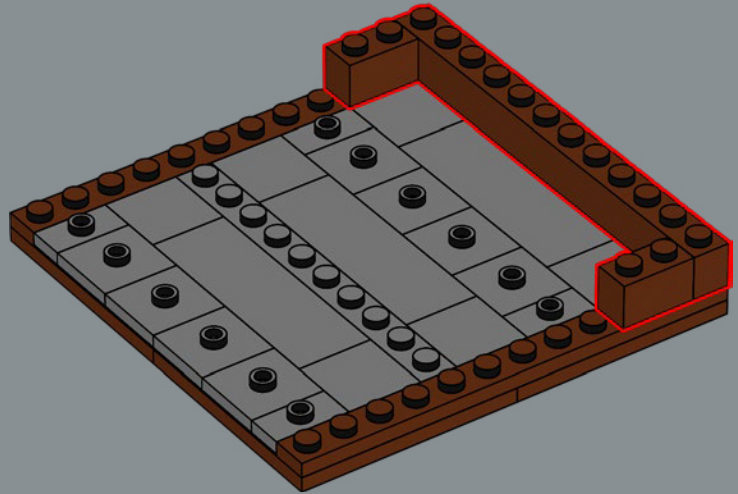

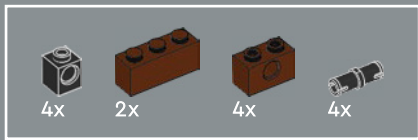

8

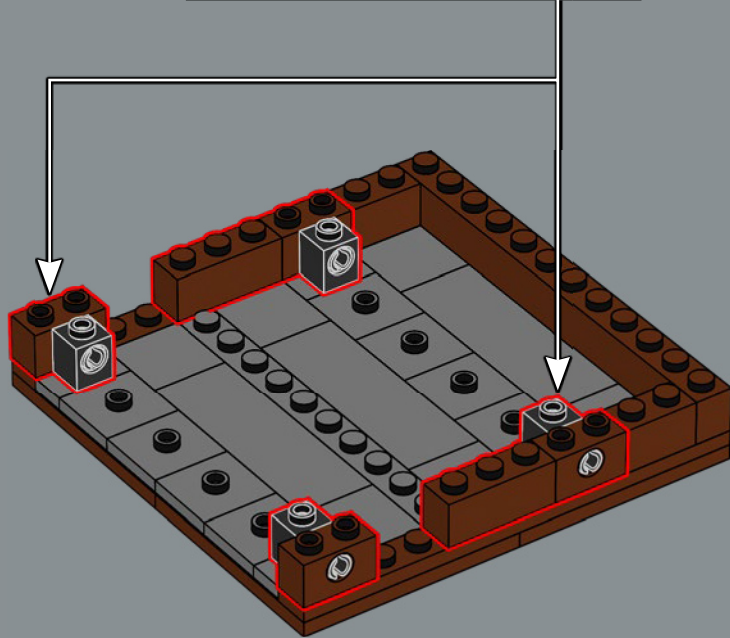
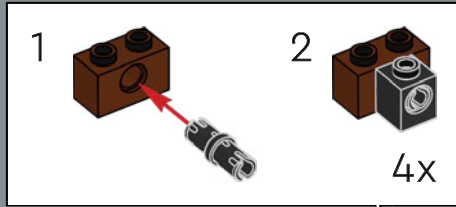

9

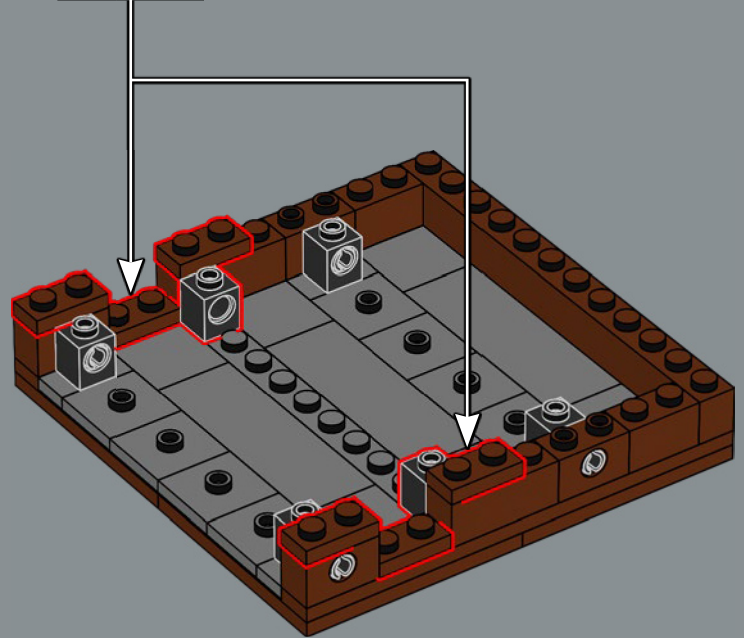
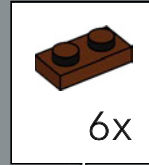

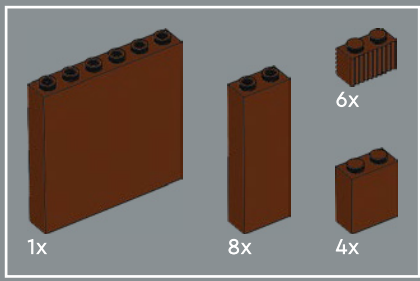

10

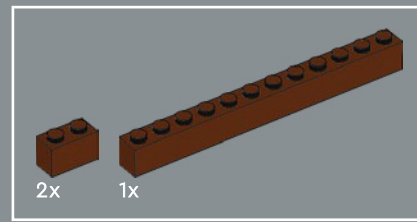
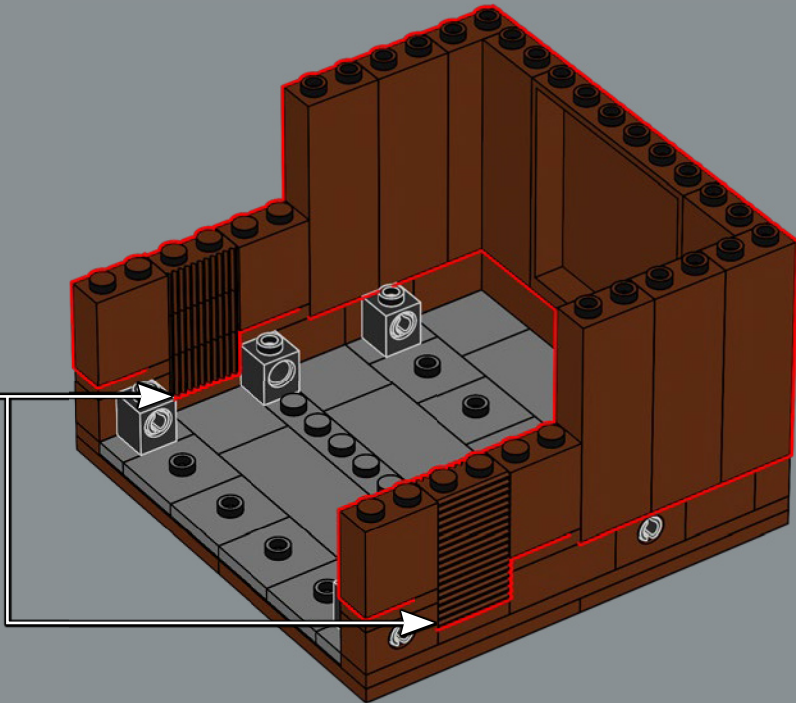
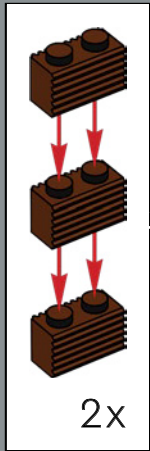

11

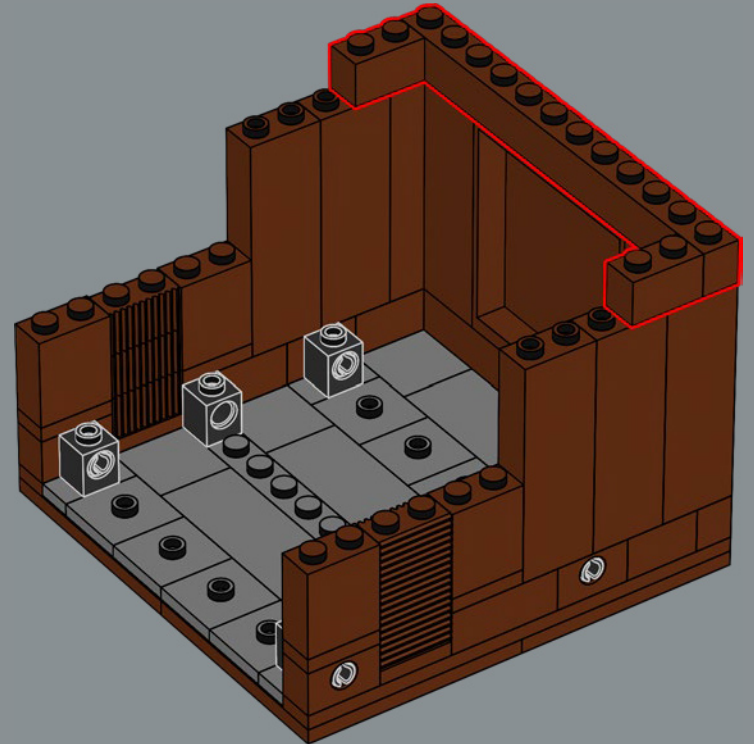

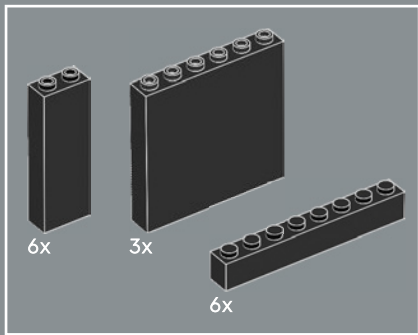

12

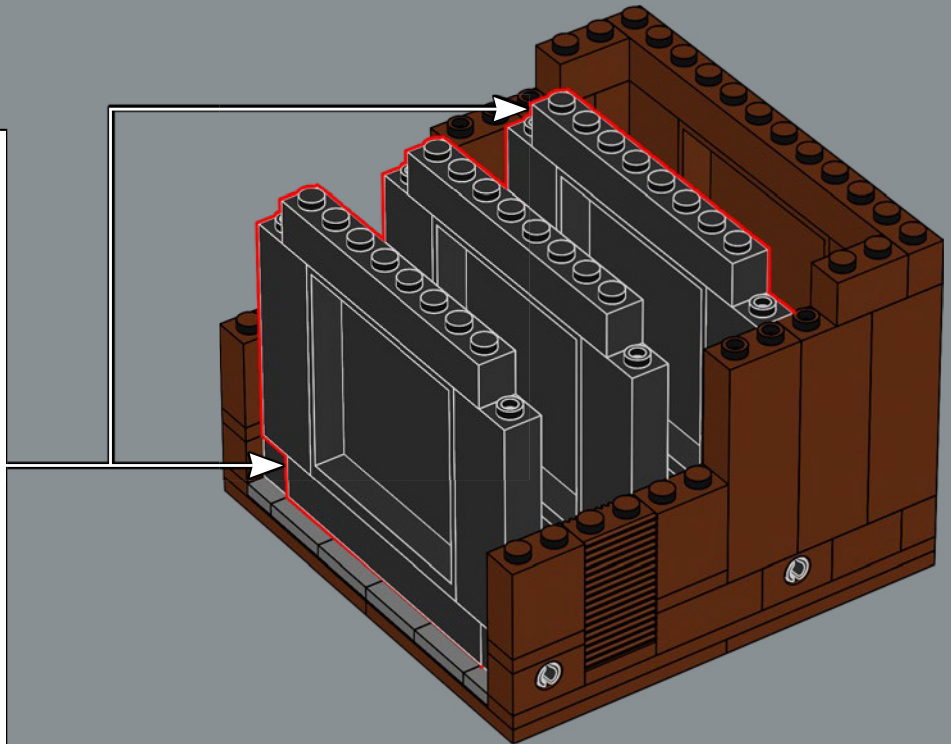
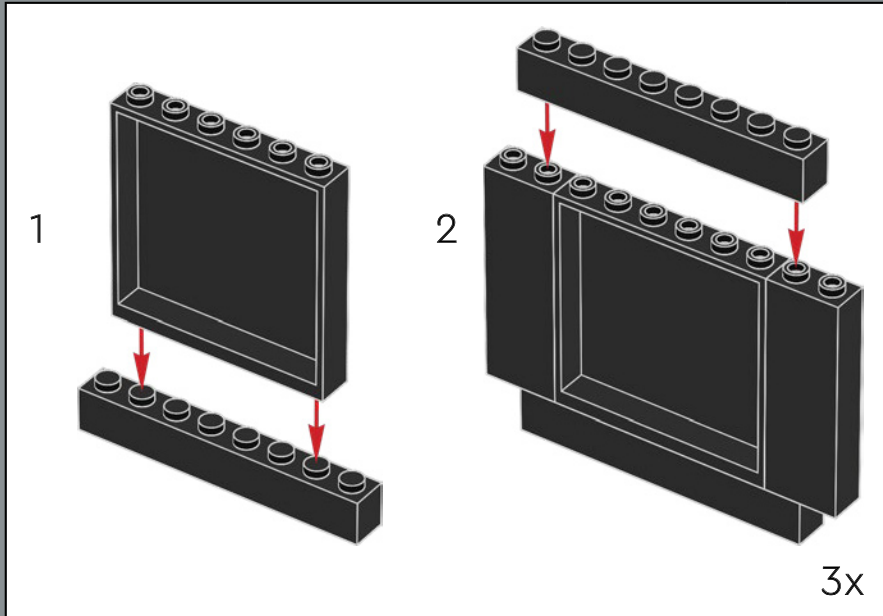

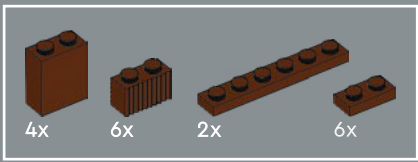

13

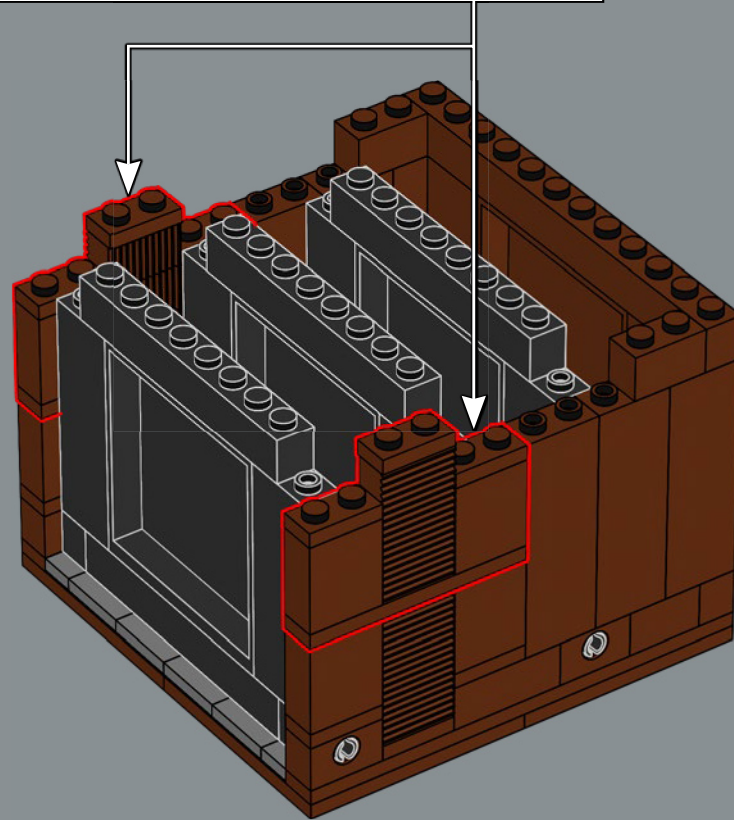
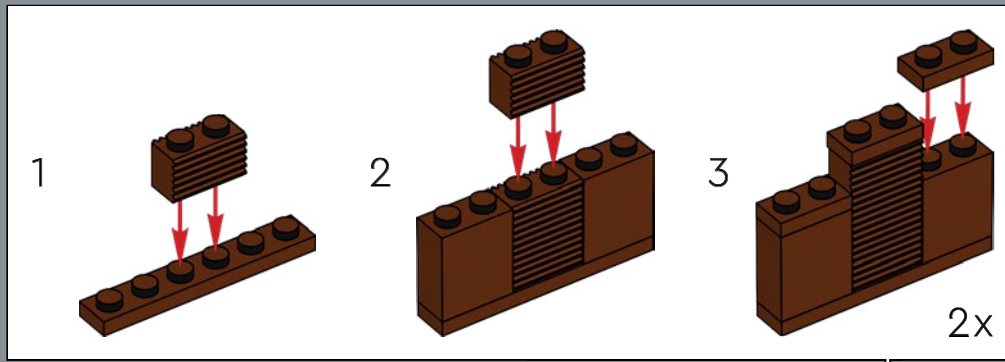

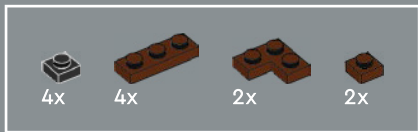

14

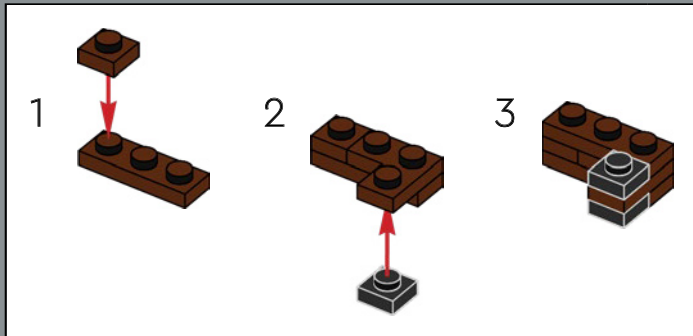
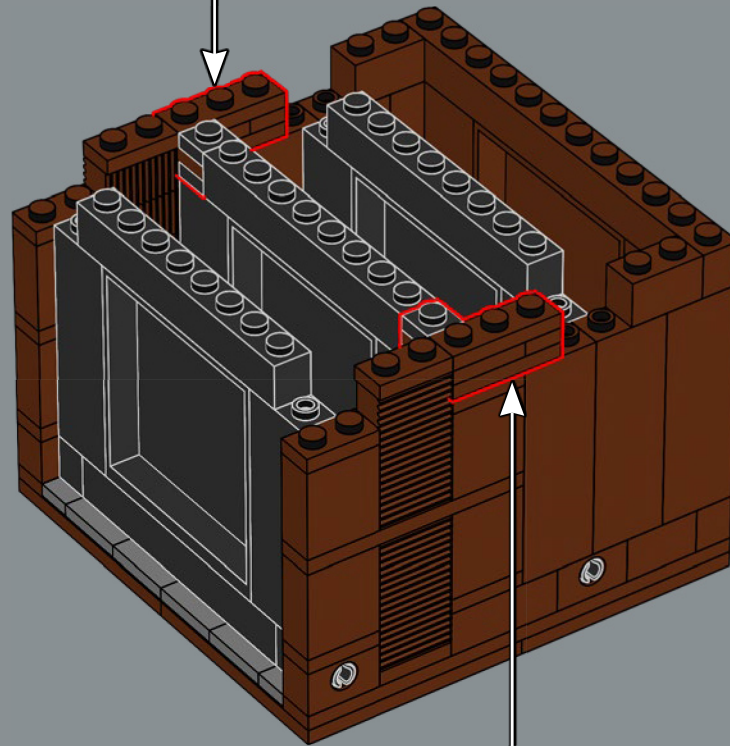
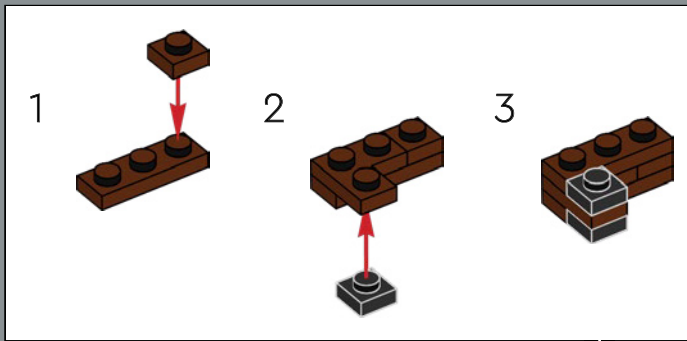

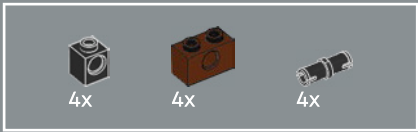

15

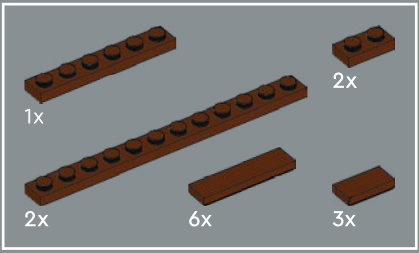
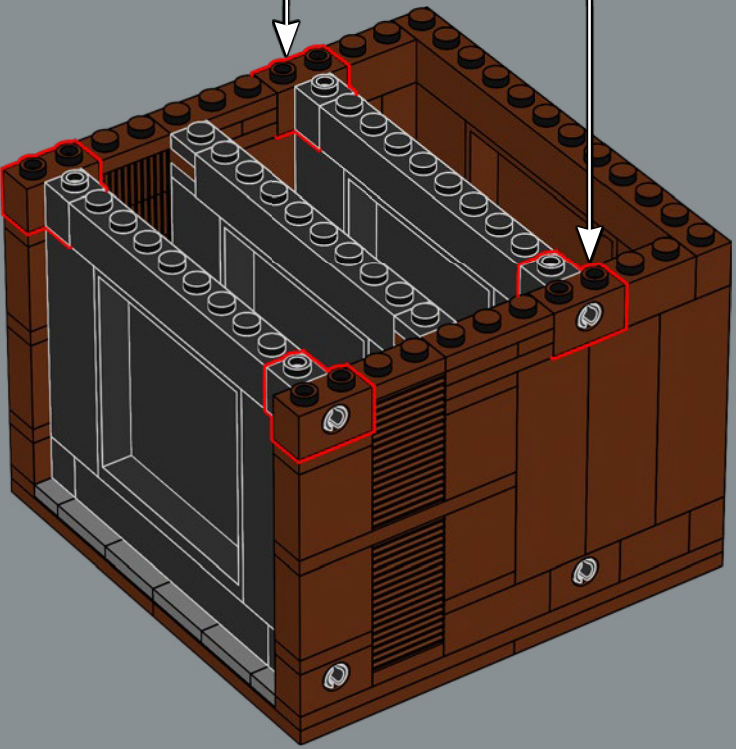
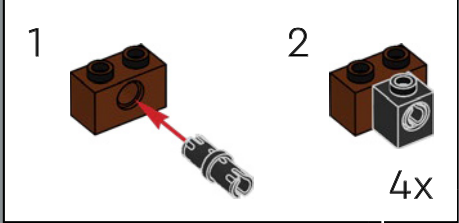

16

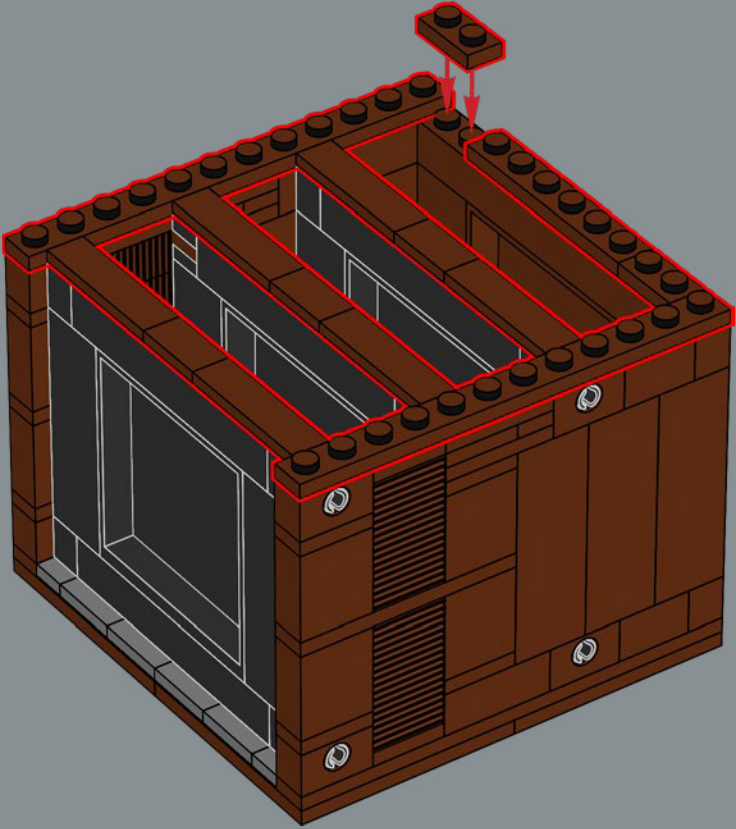

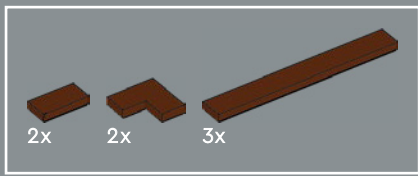

17

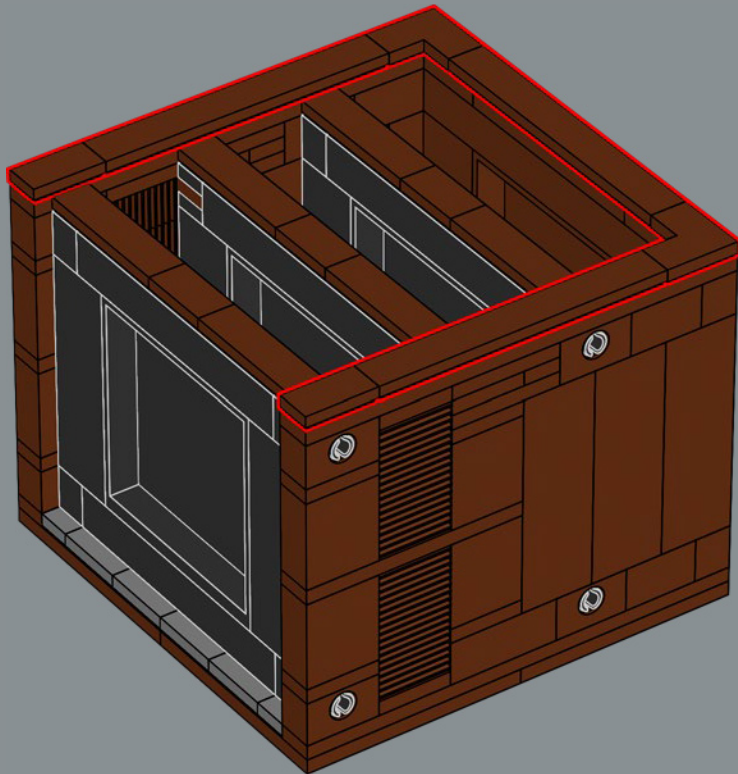

18

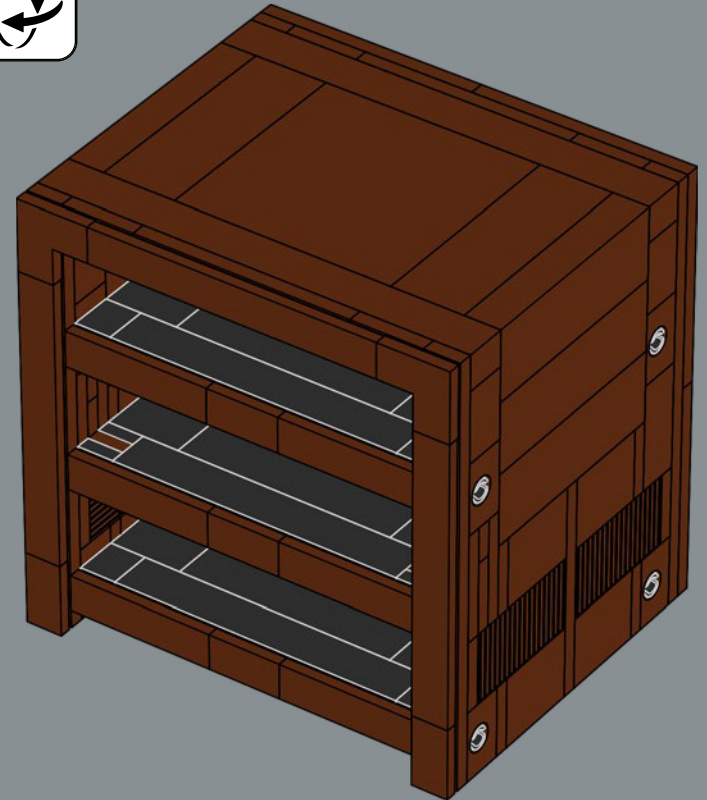

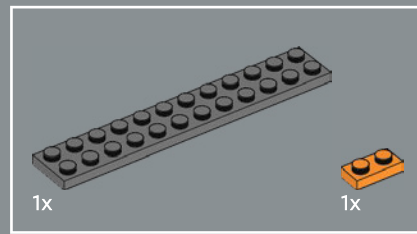
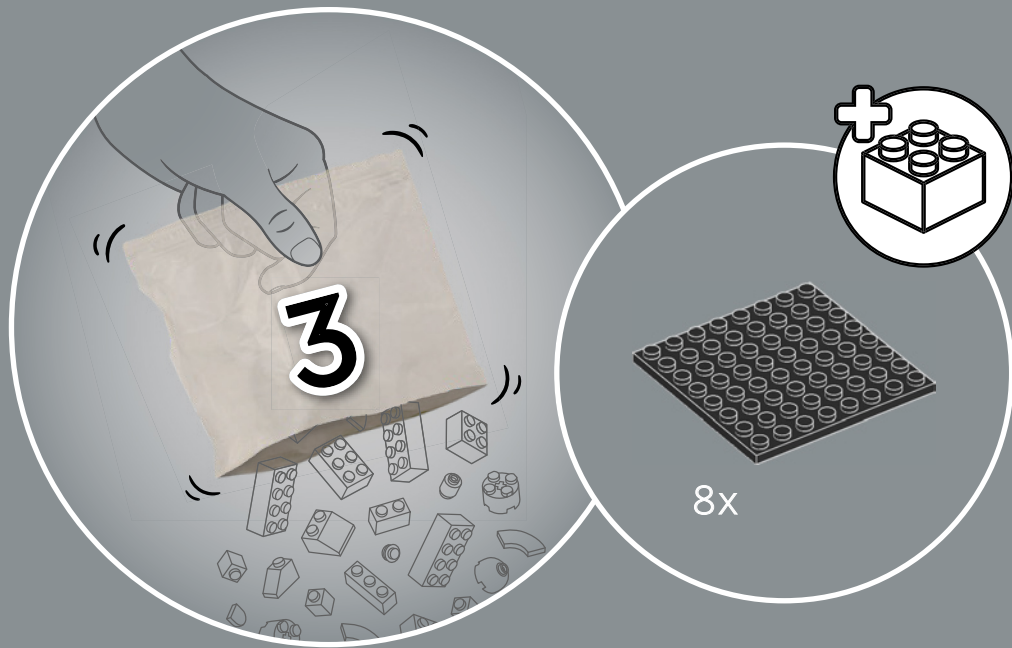

1

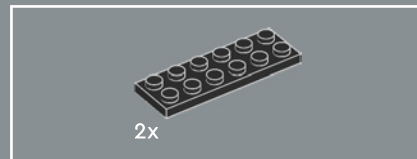
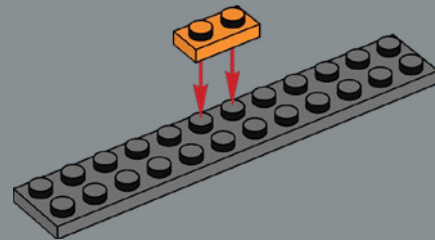

2

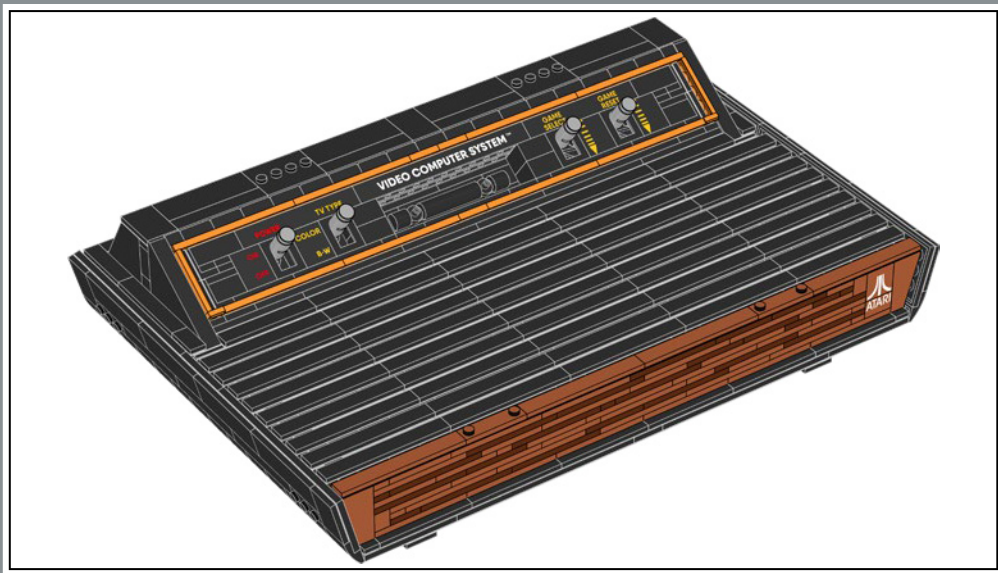
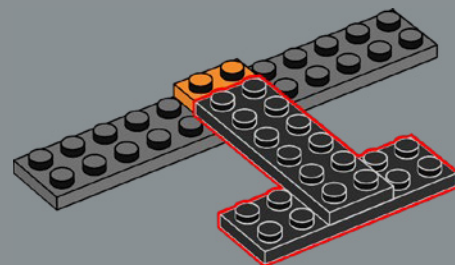

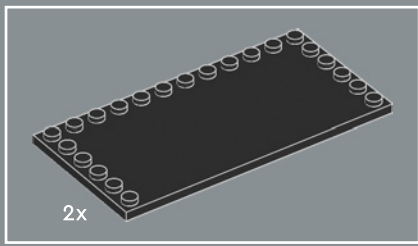

3

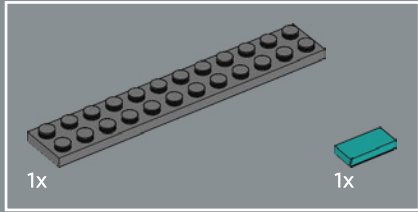
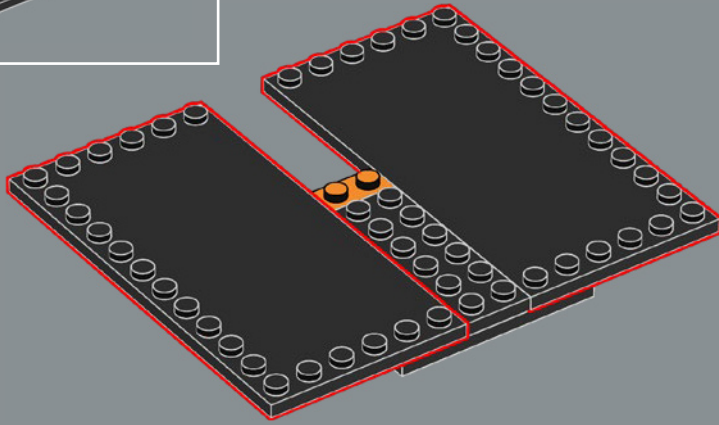

4

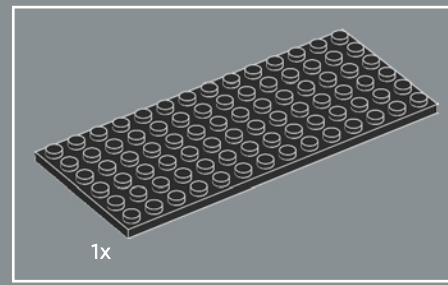
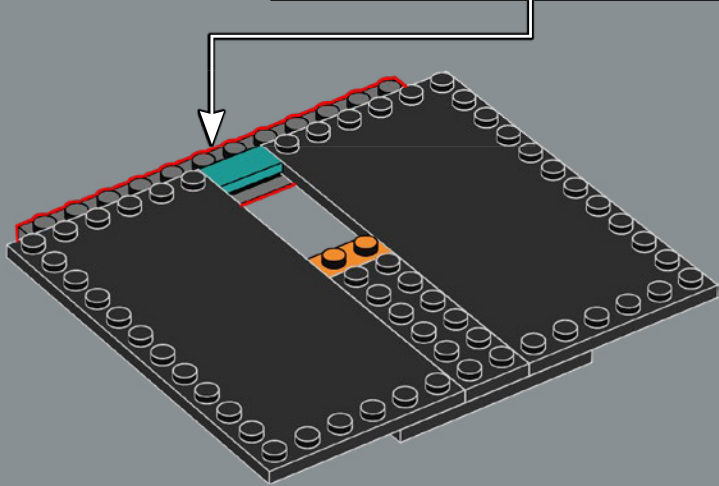
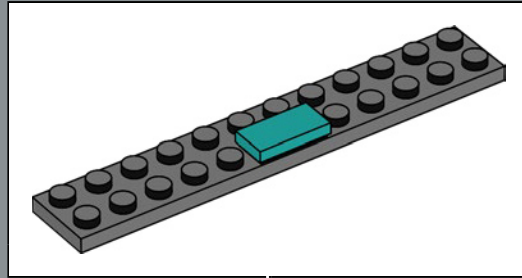

5

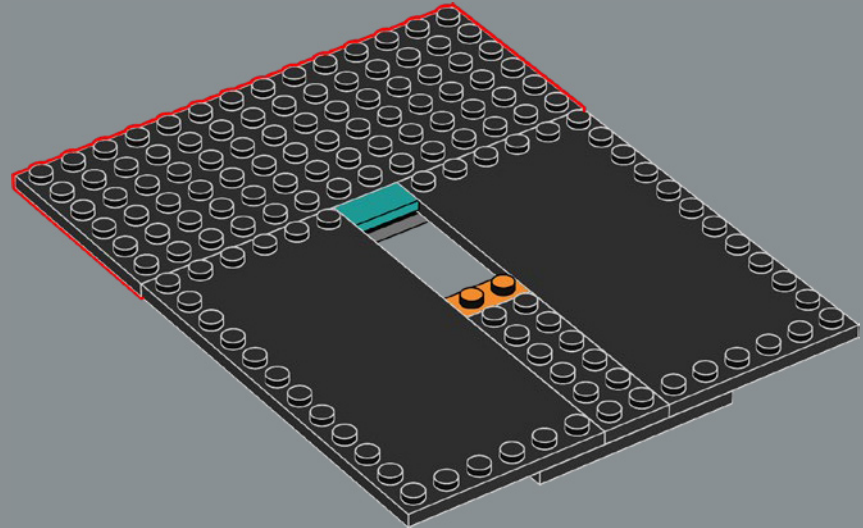

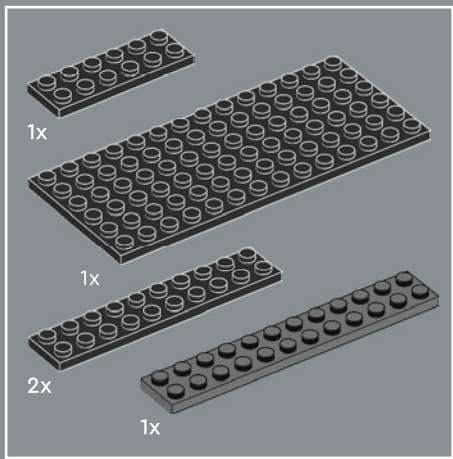

6

1

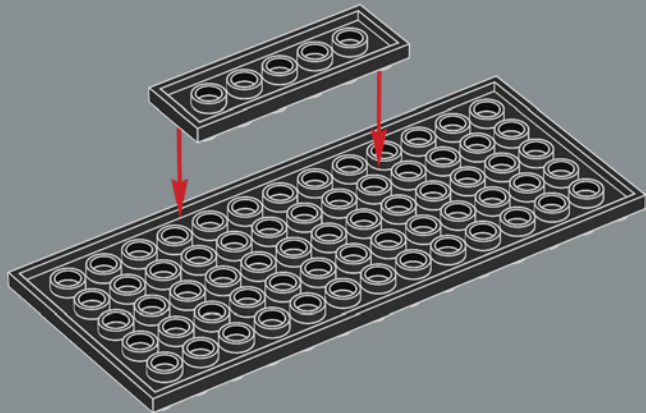

2

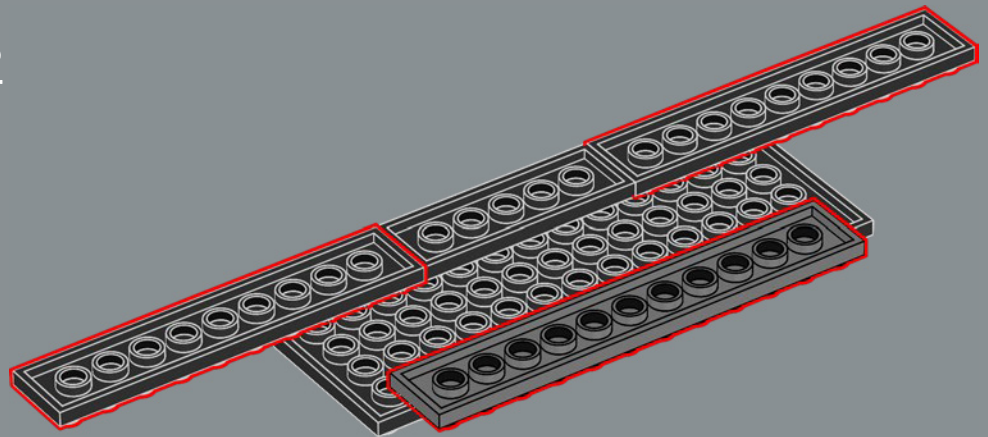

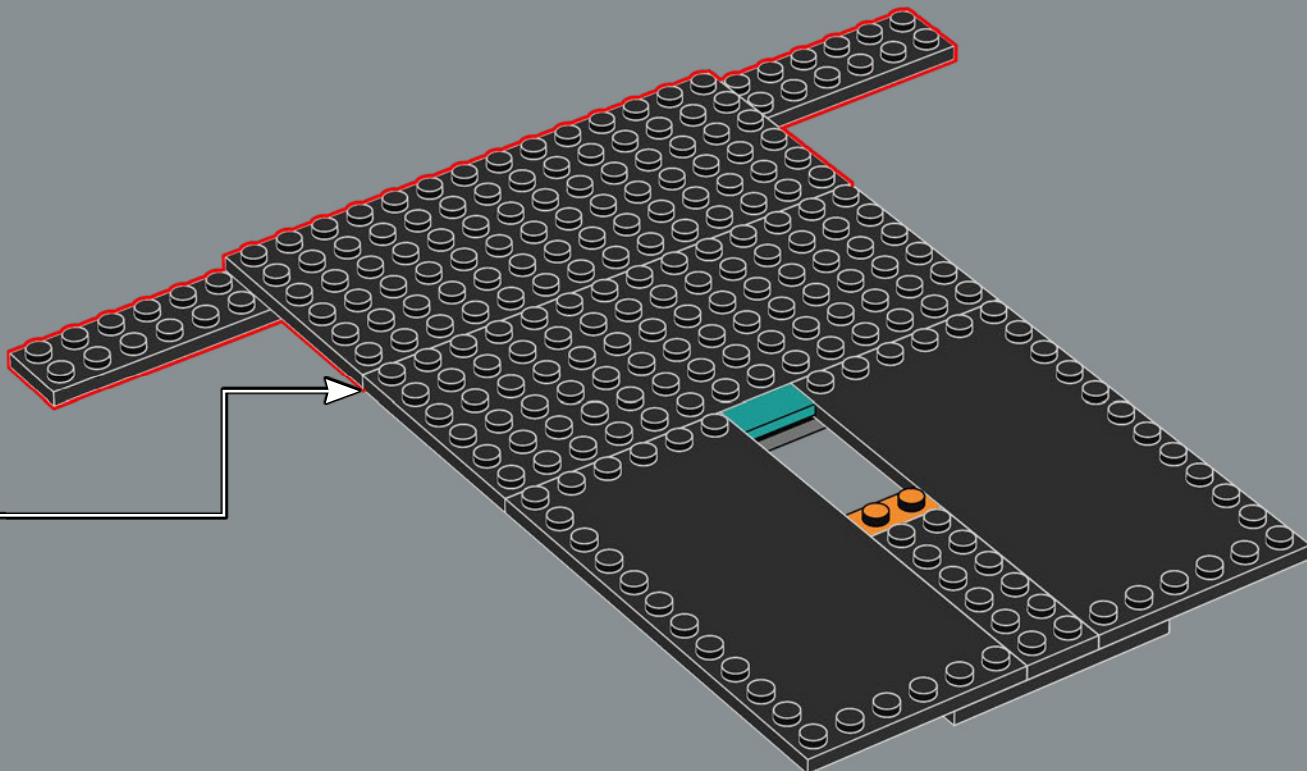

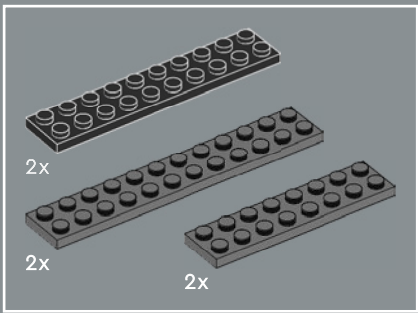

7

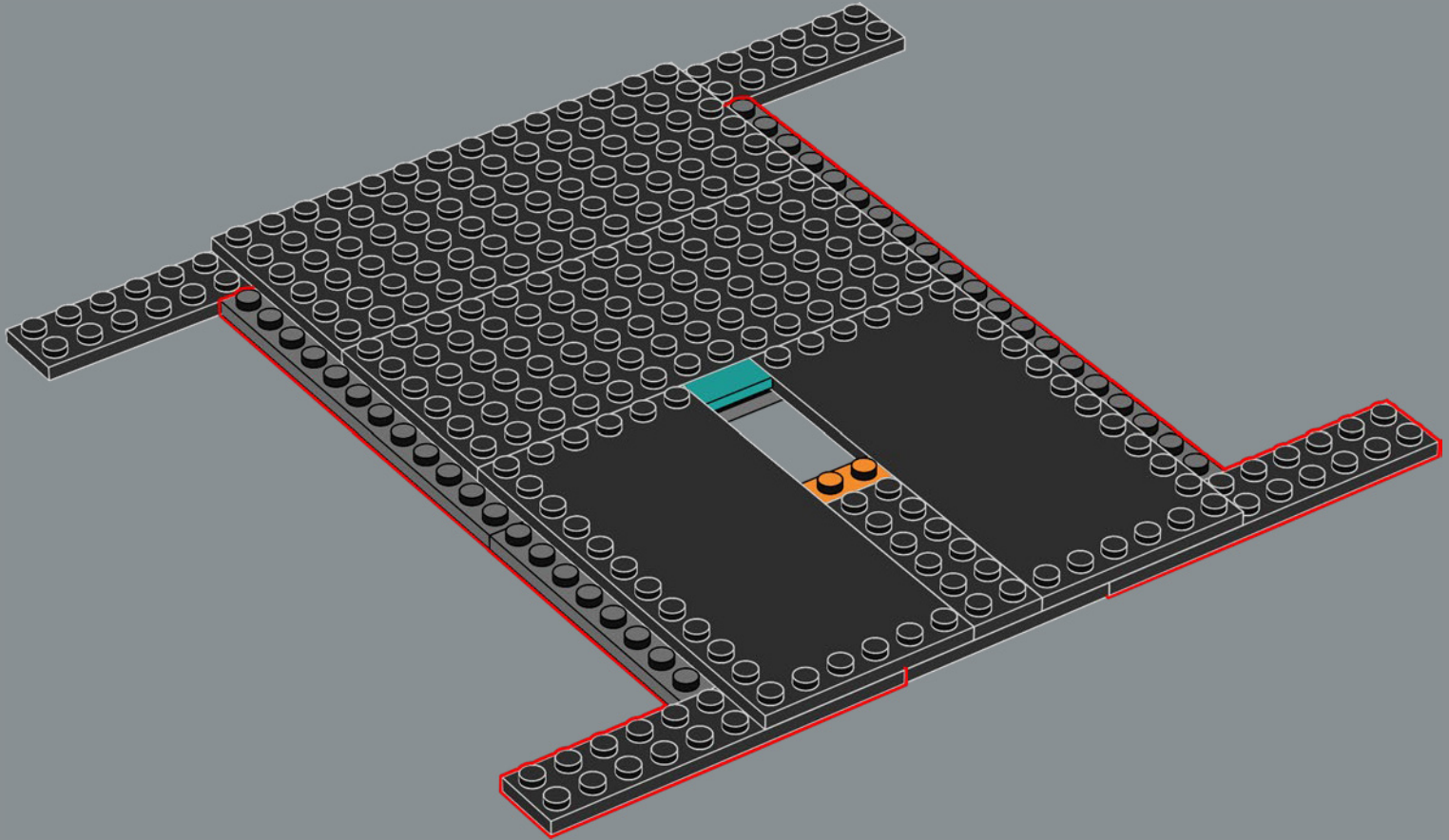

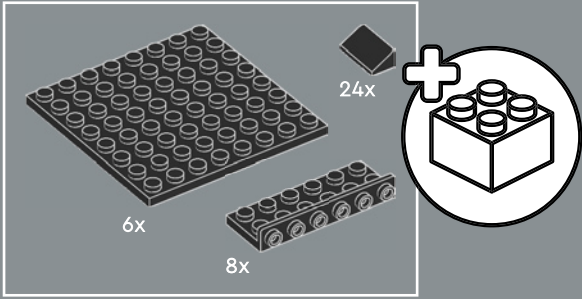
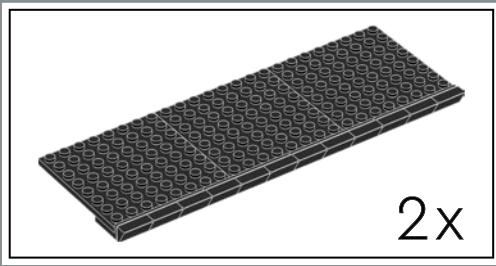

8

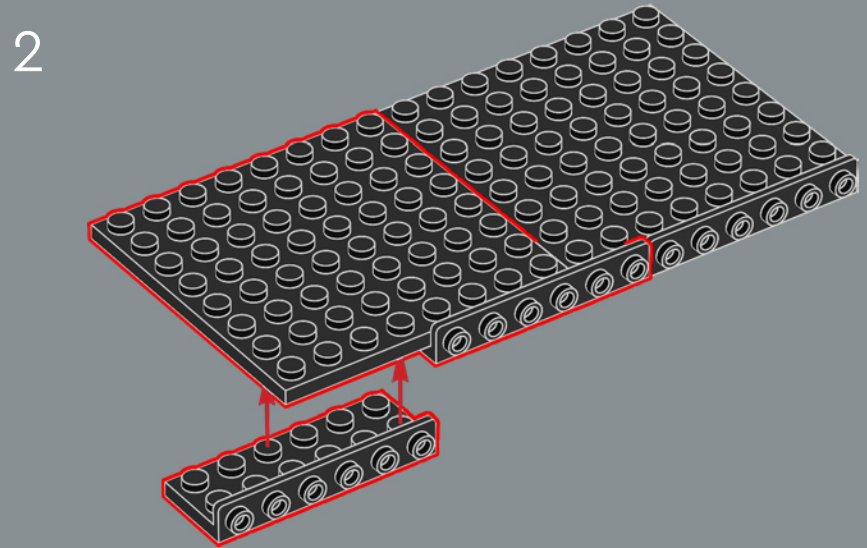
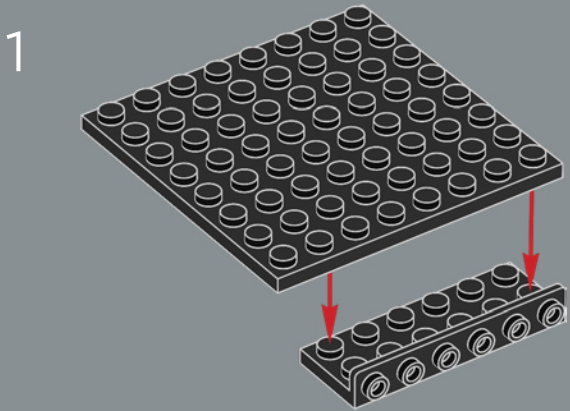

3

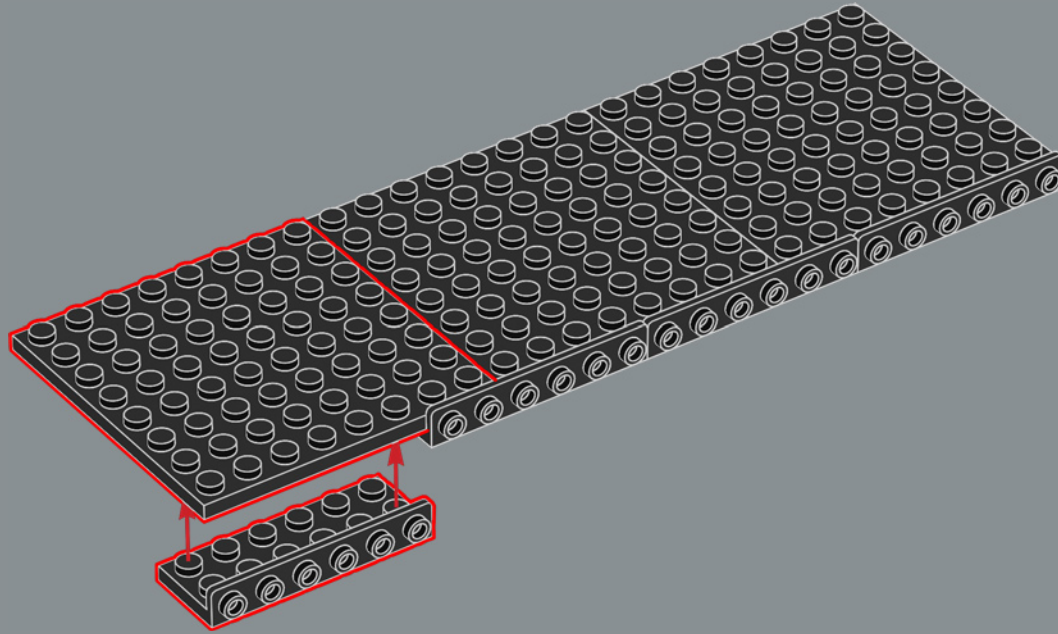

4

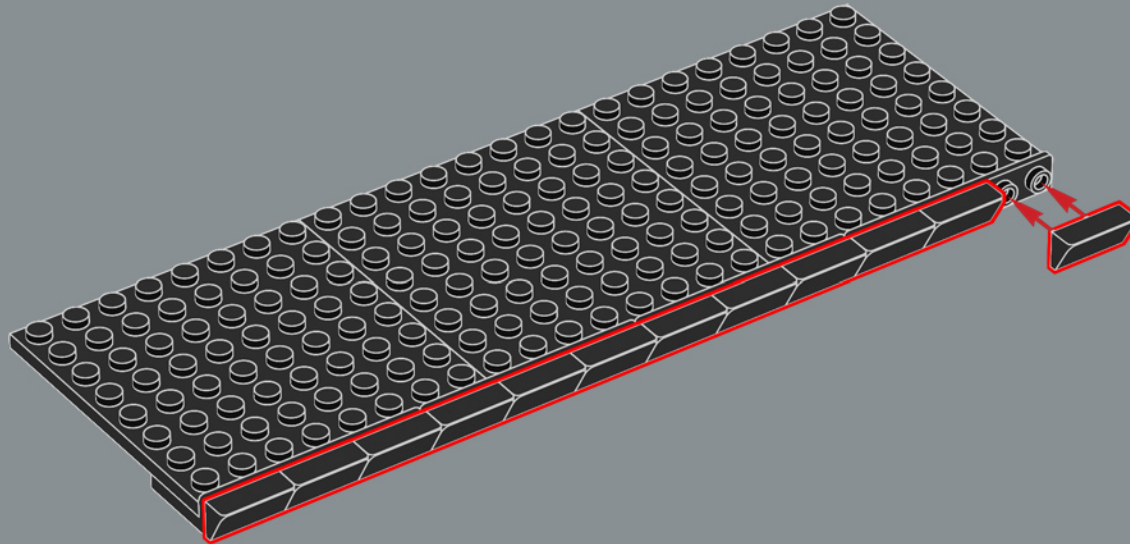

2x

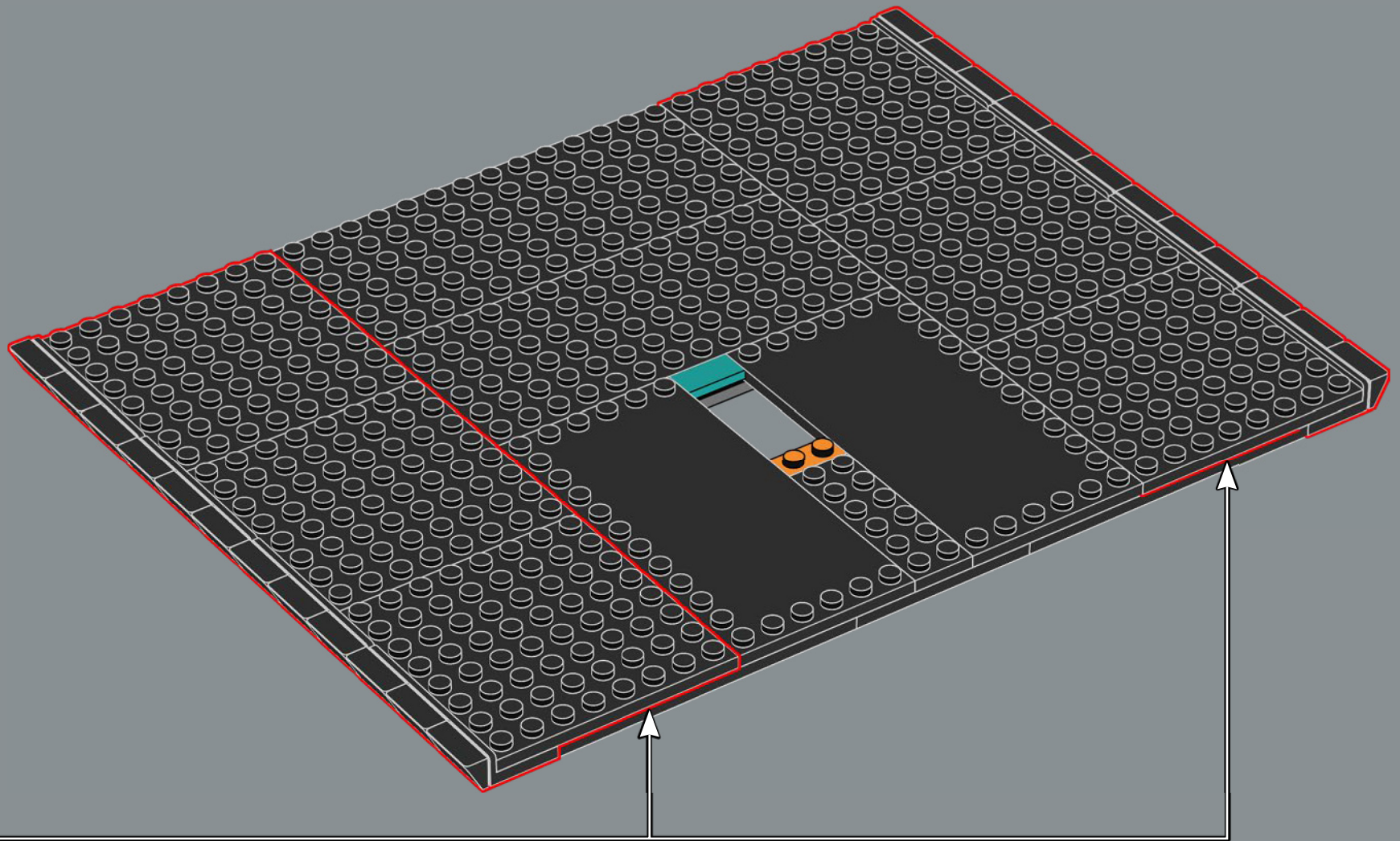

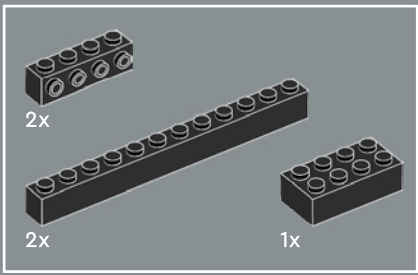

9

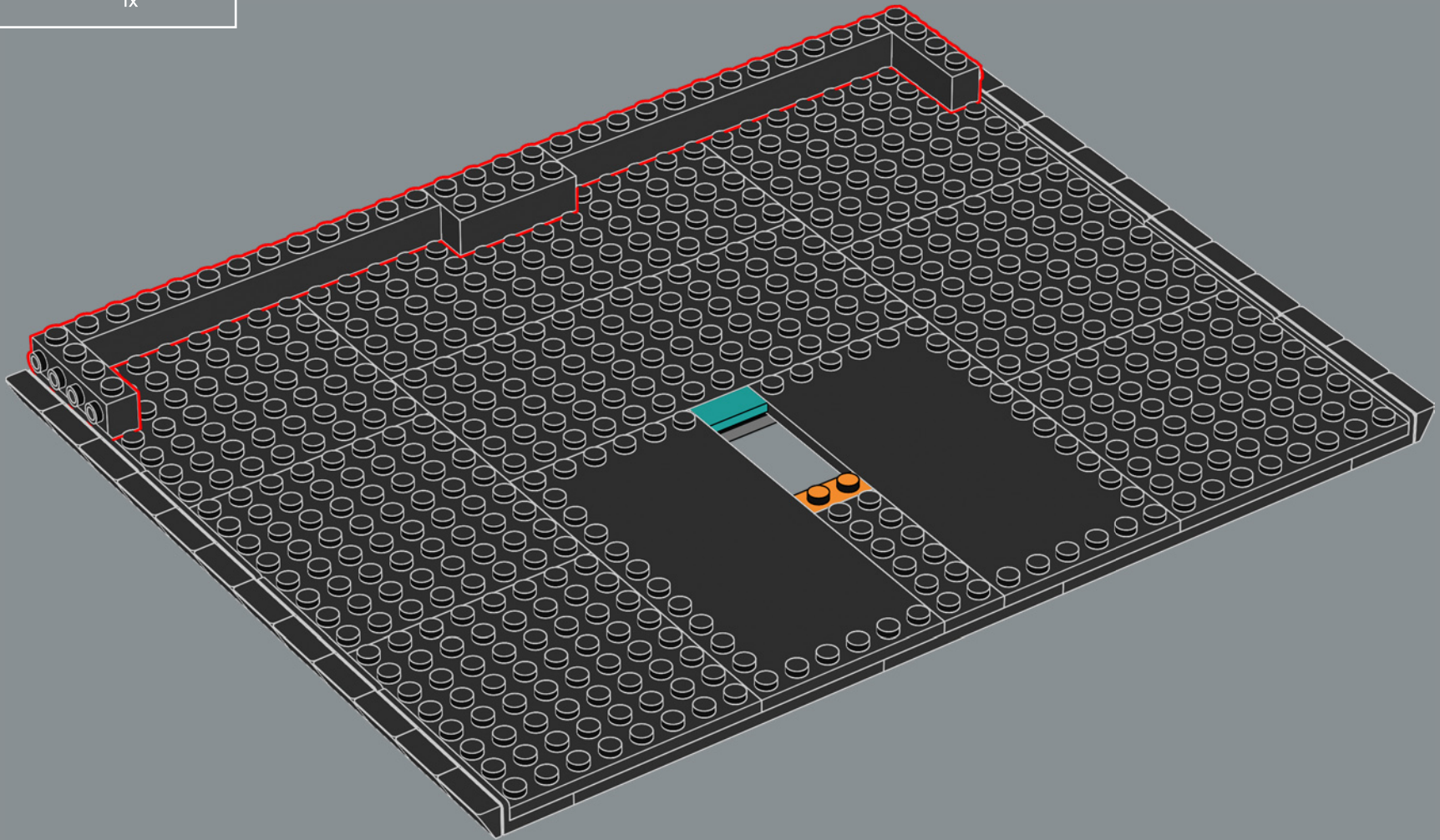

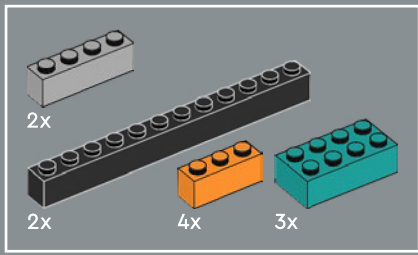

10

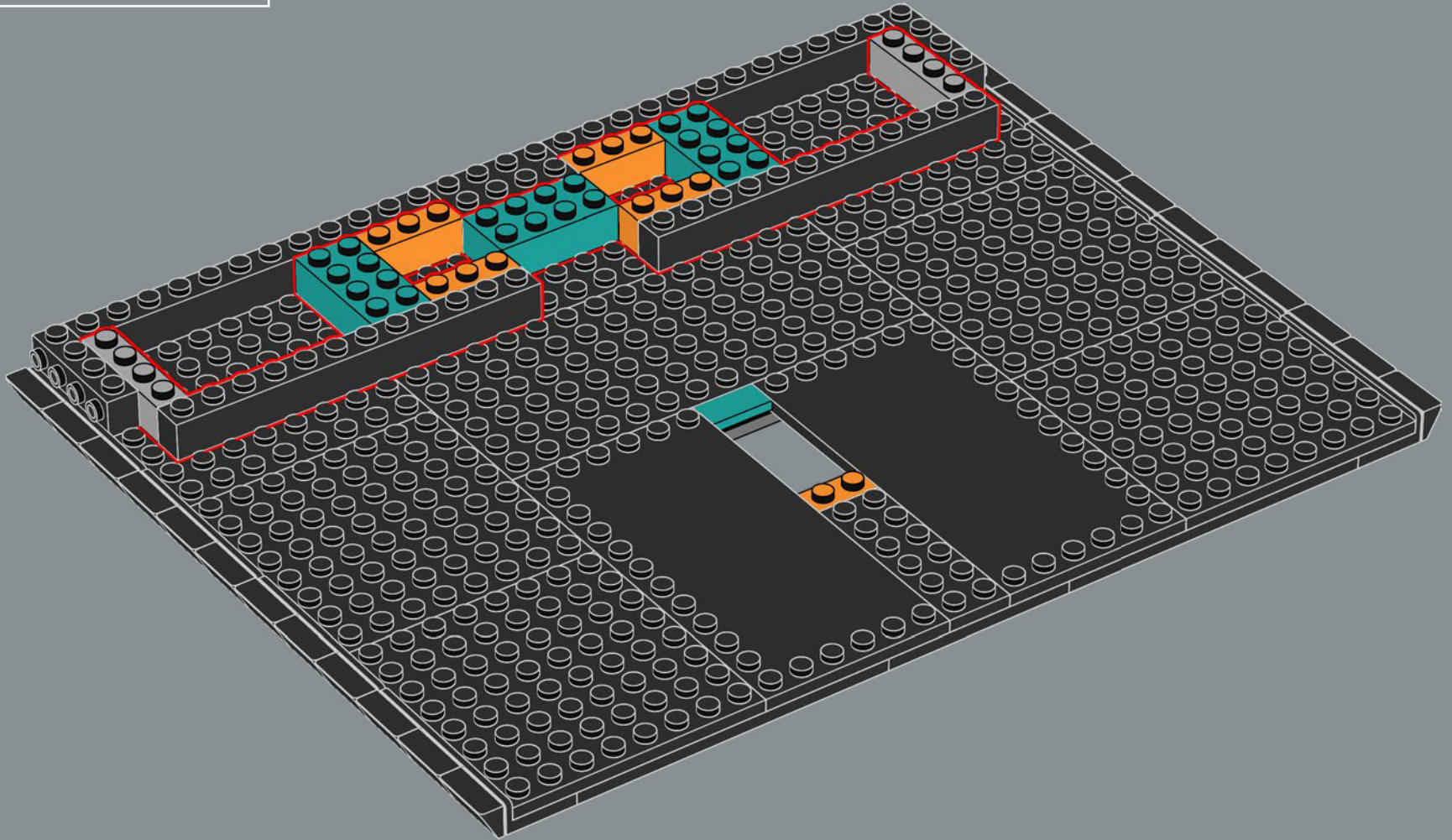

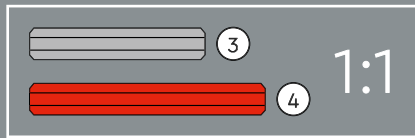
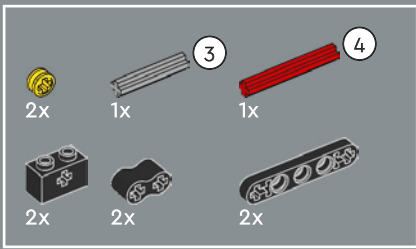

11

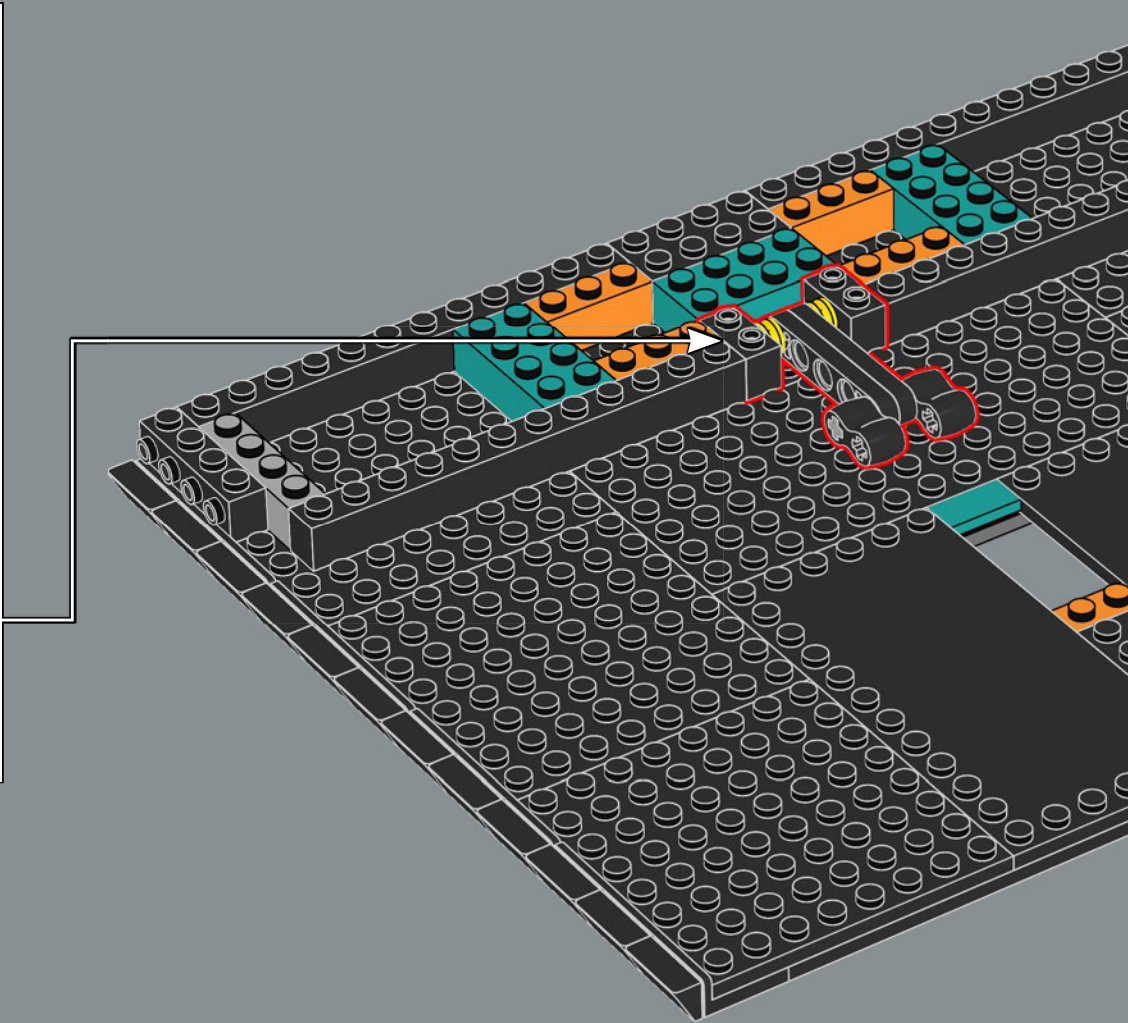
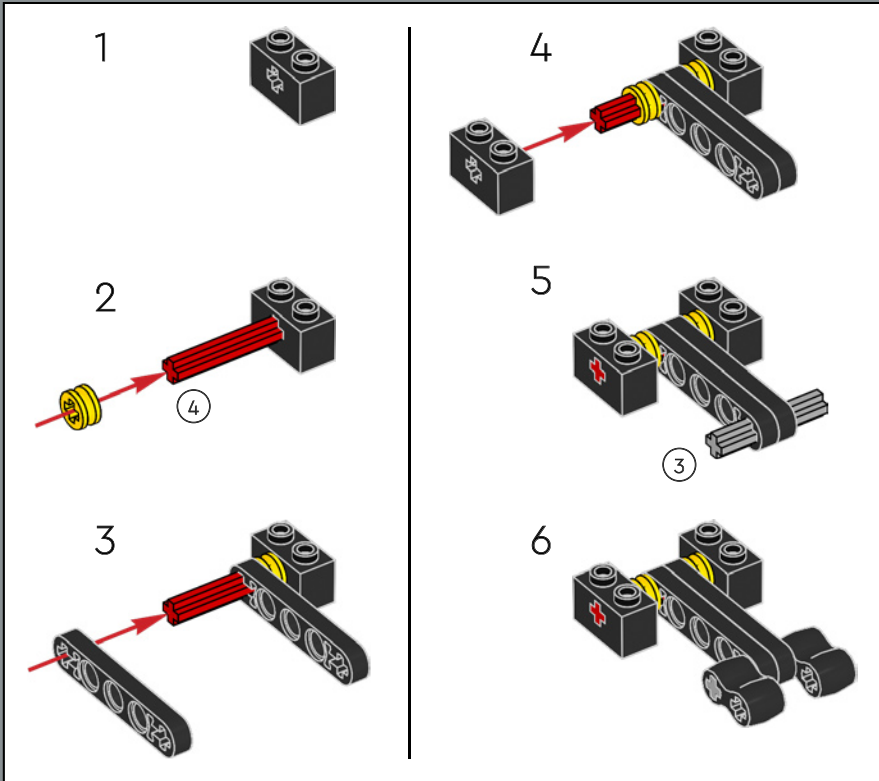

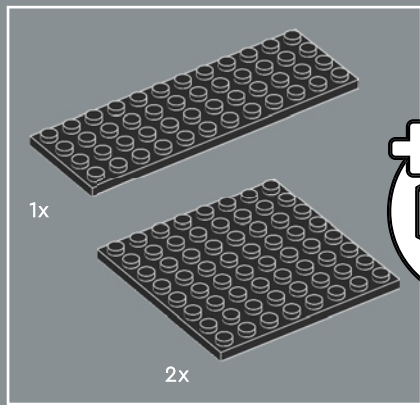

12

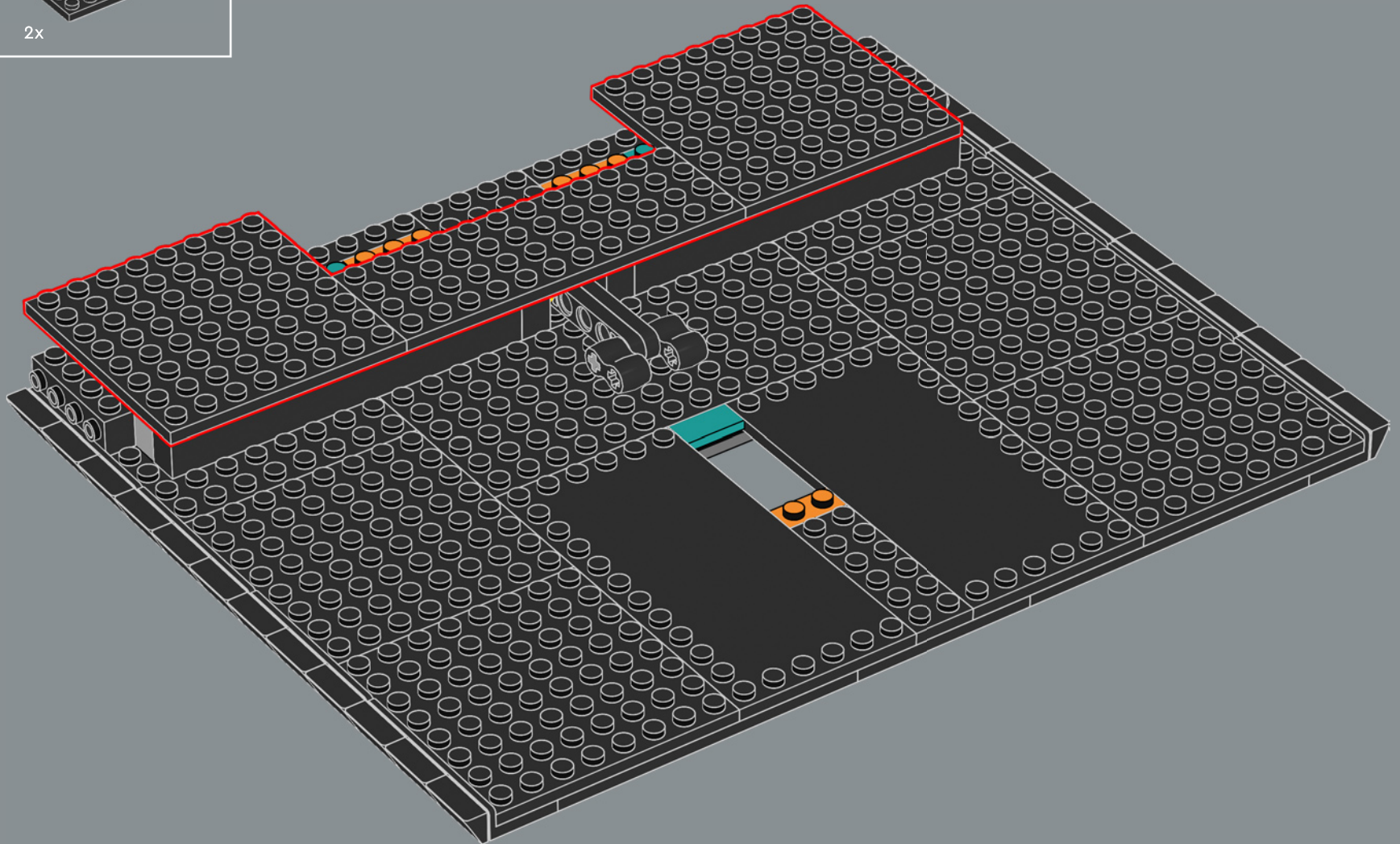

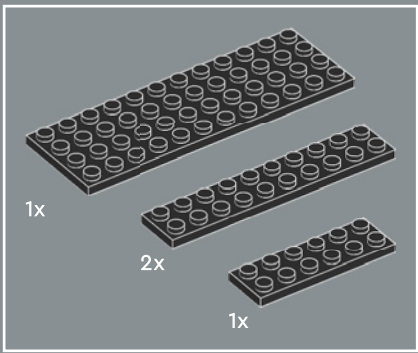

13

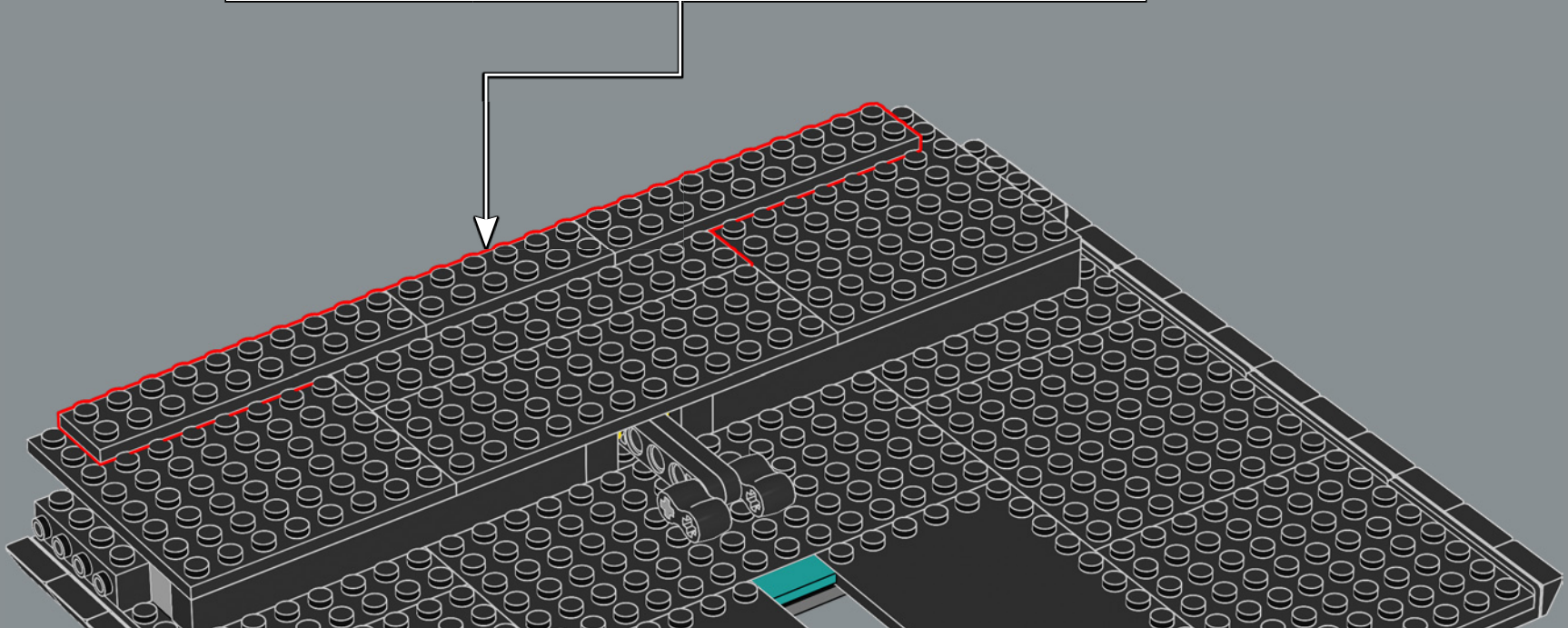
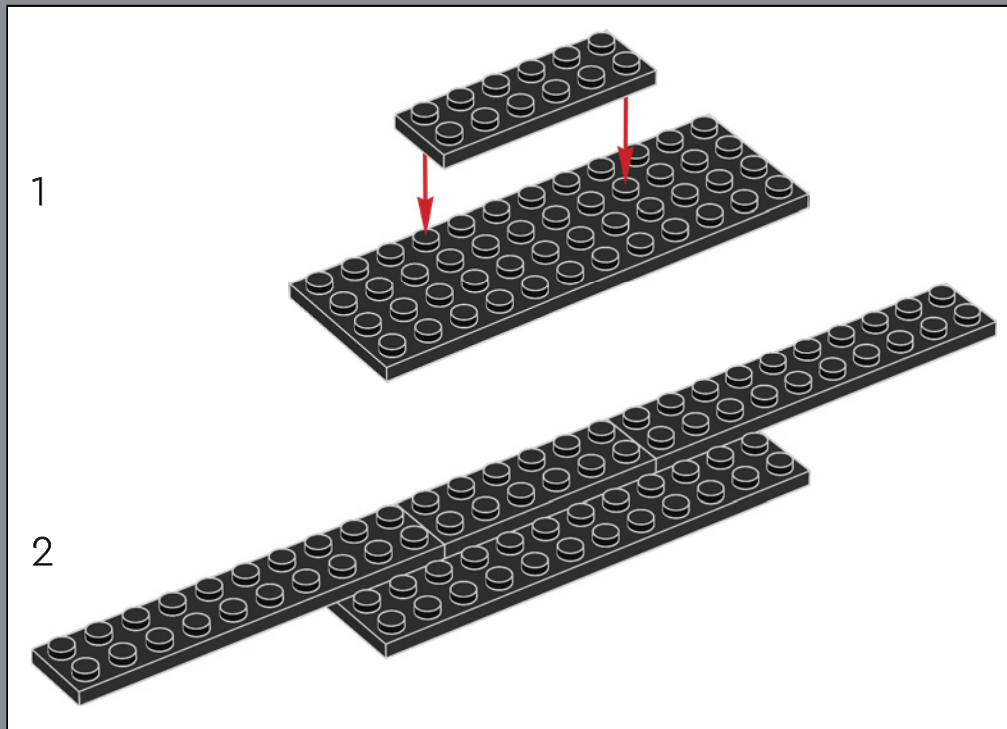

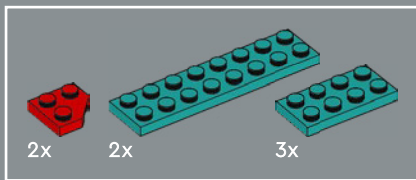

14

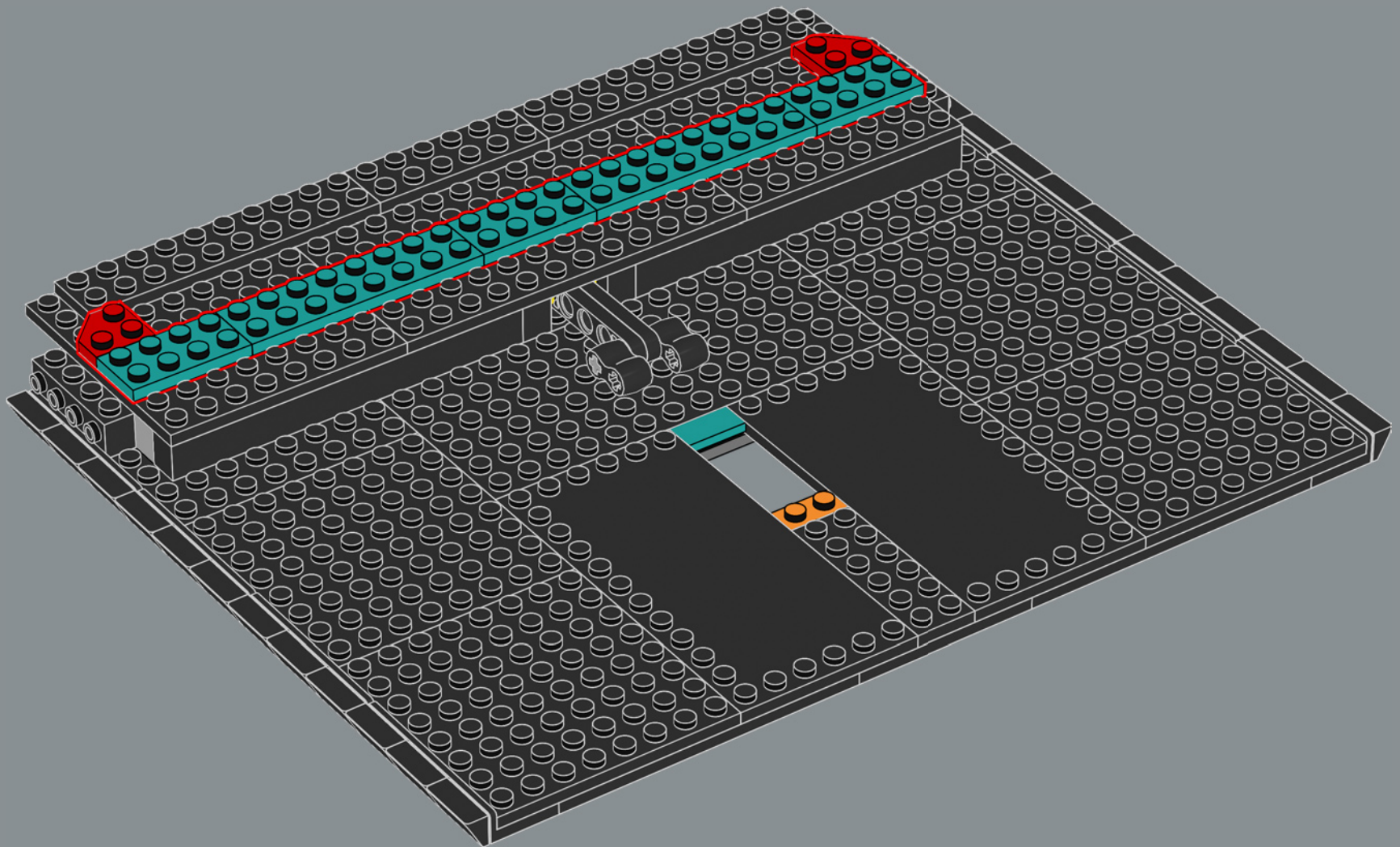

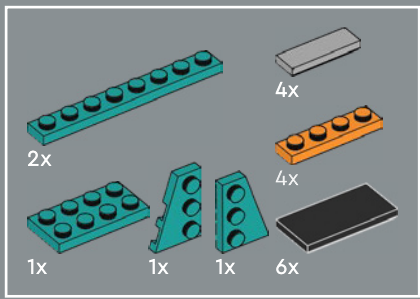

15

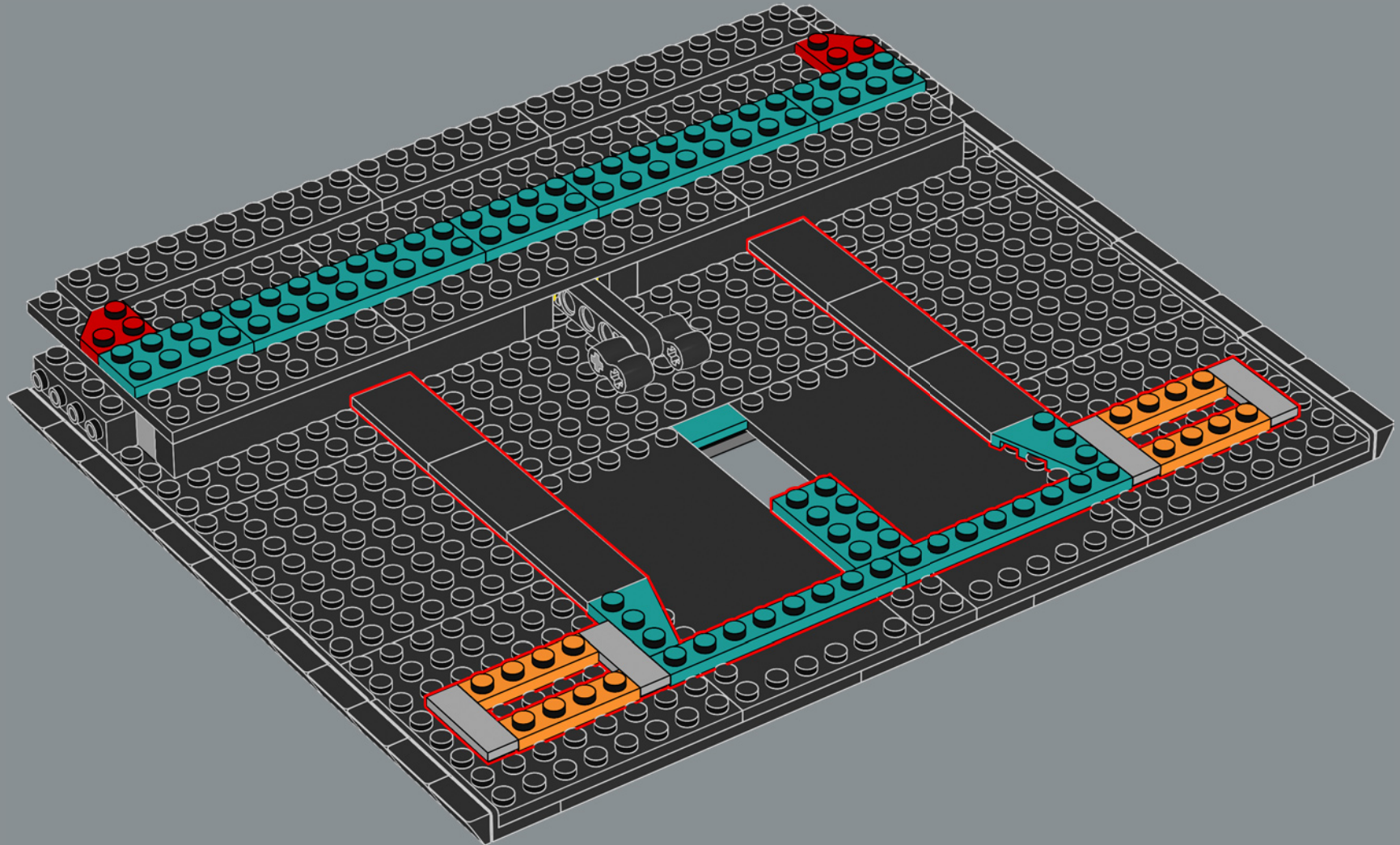

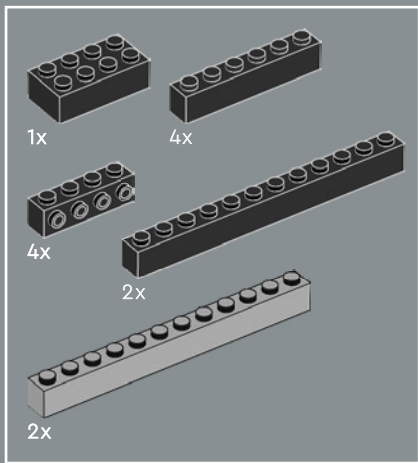

16

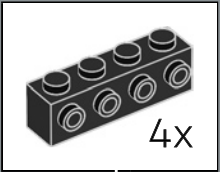
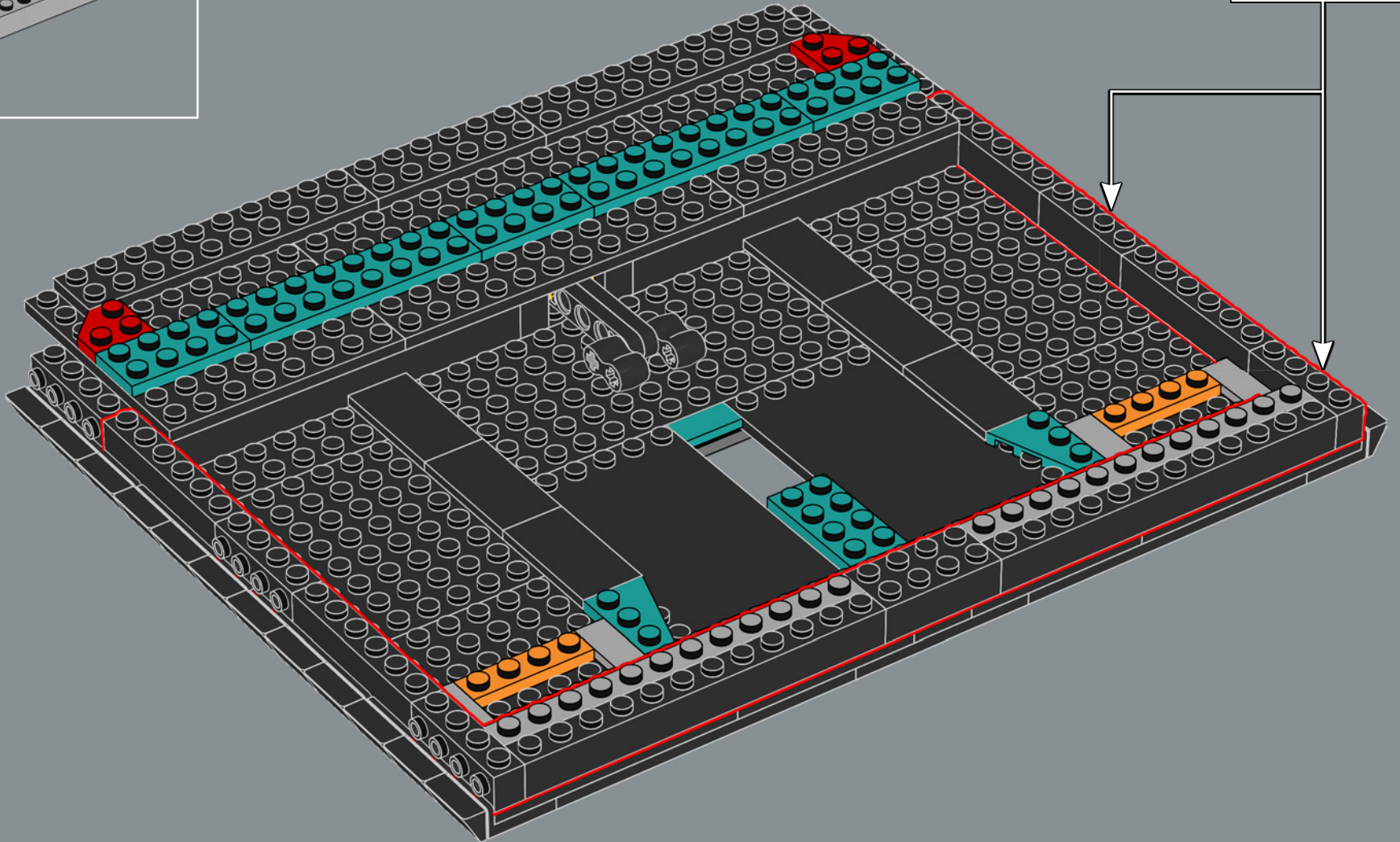

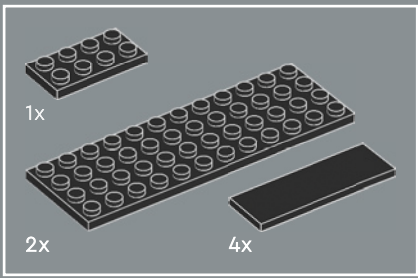

17

1

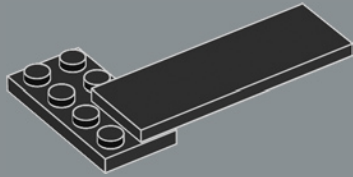

2

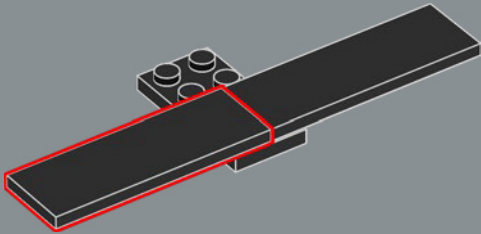

3

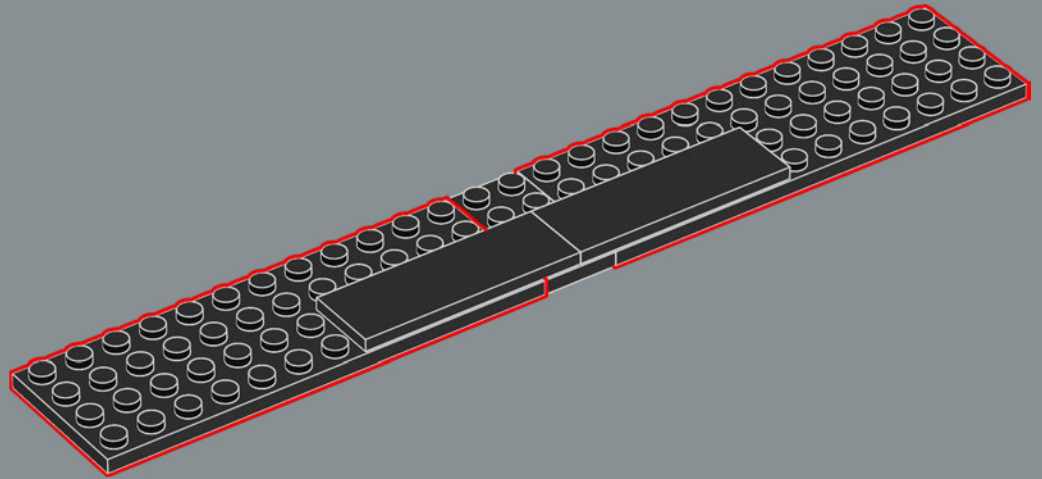

4

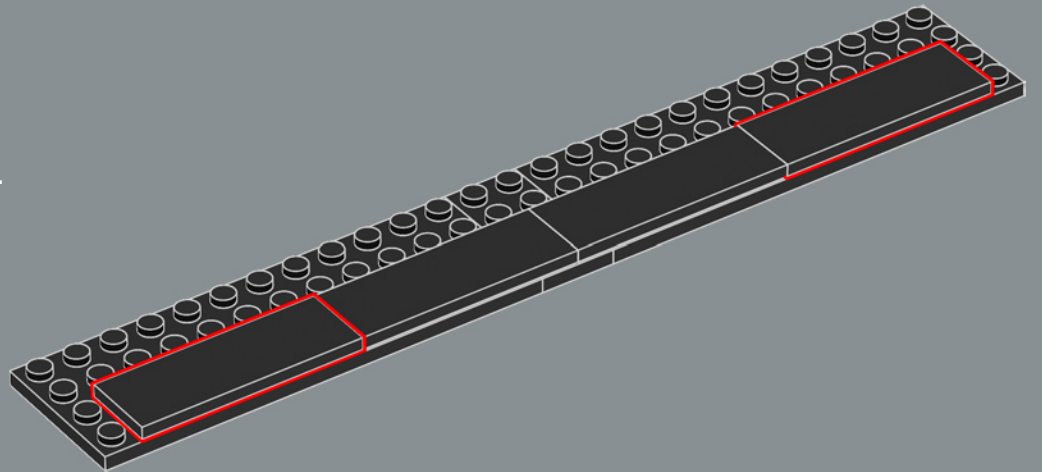

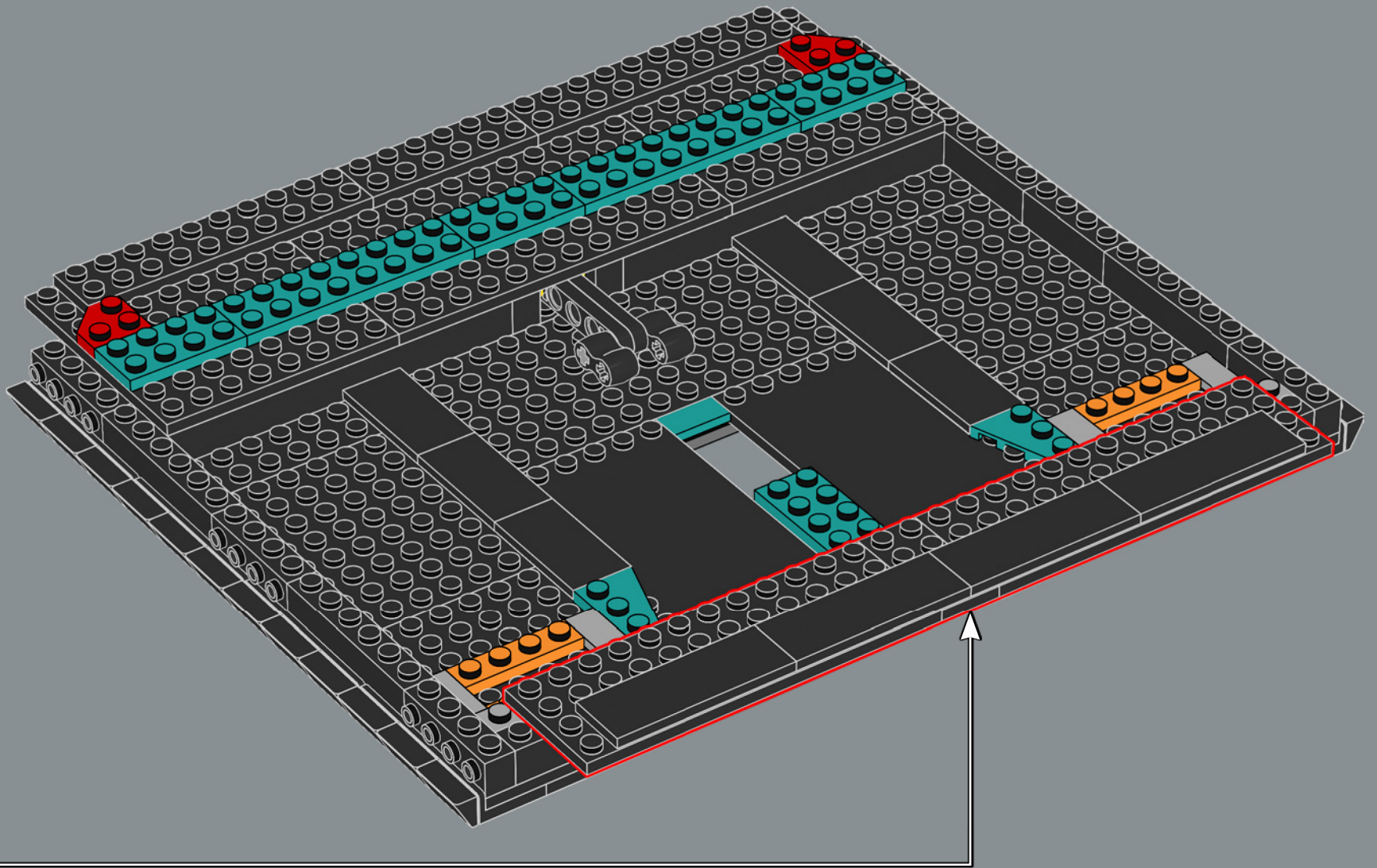

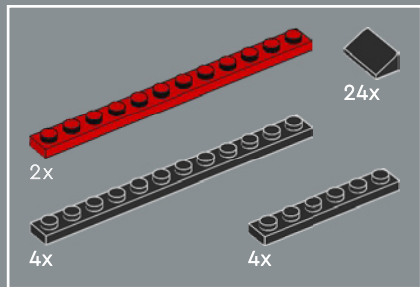
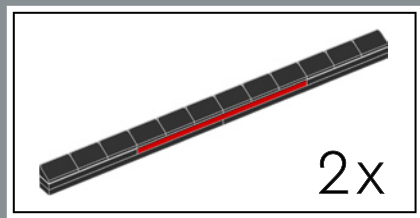

18

1

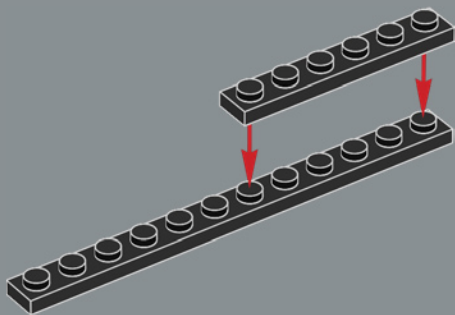

2

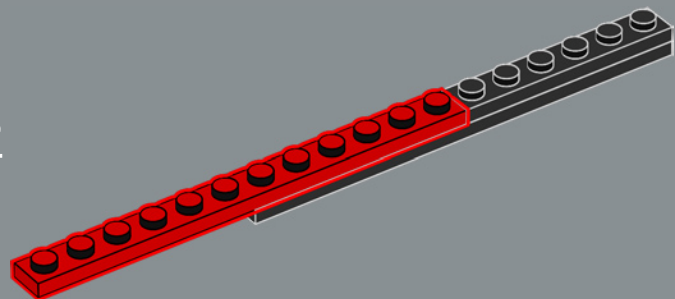

3

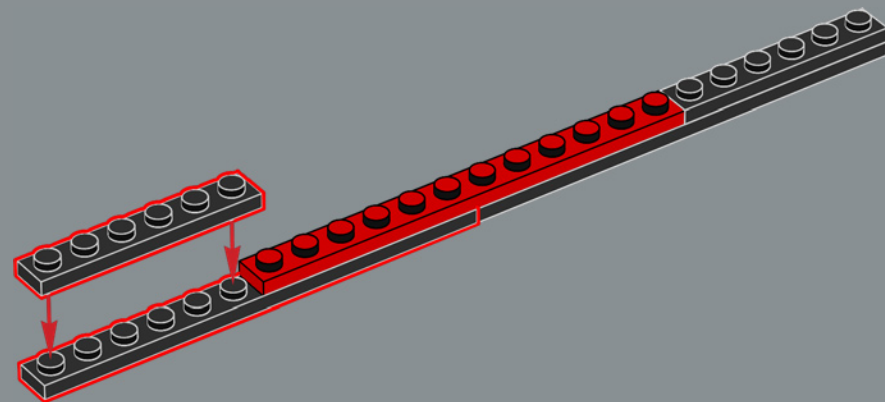

4

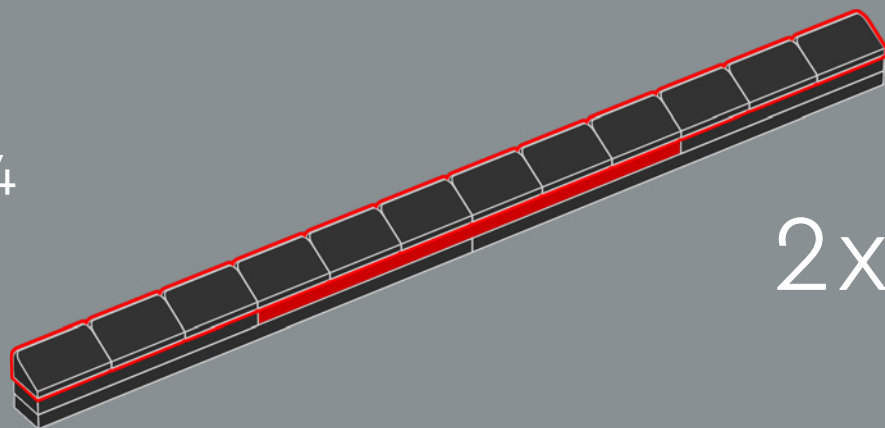

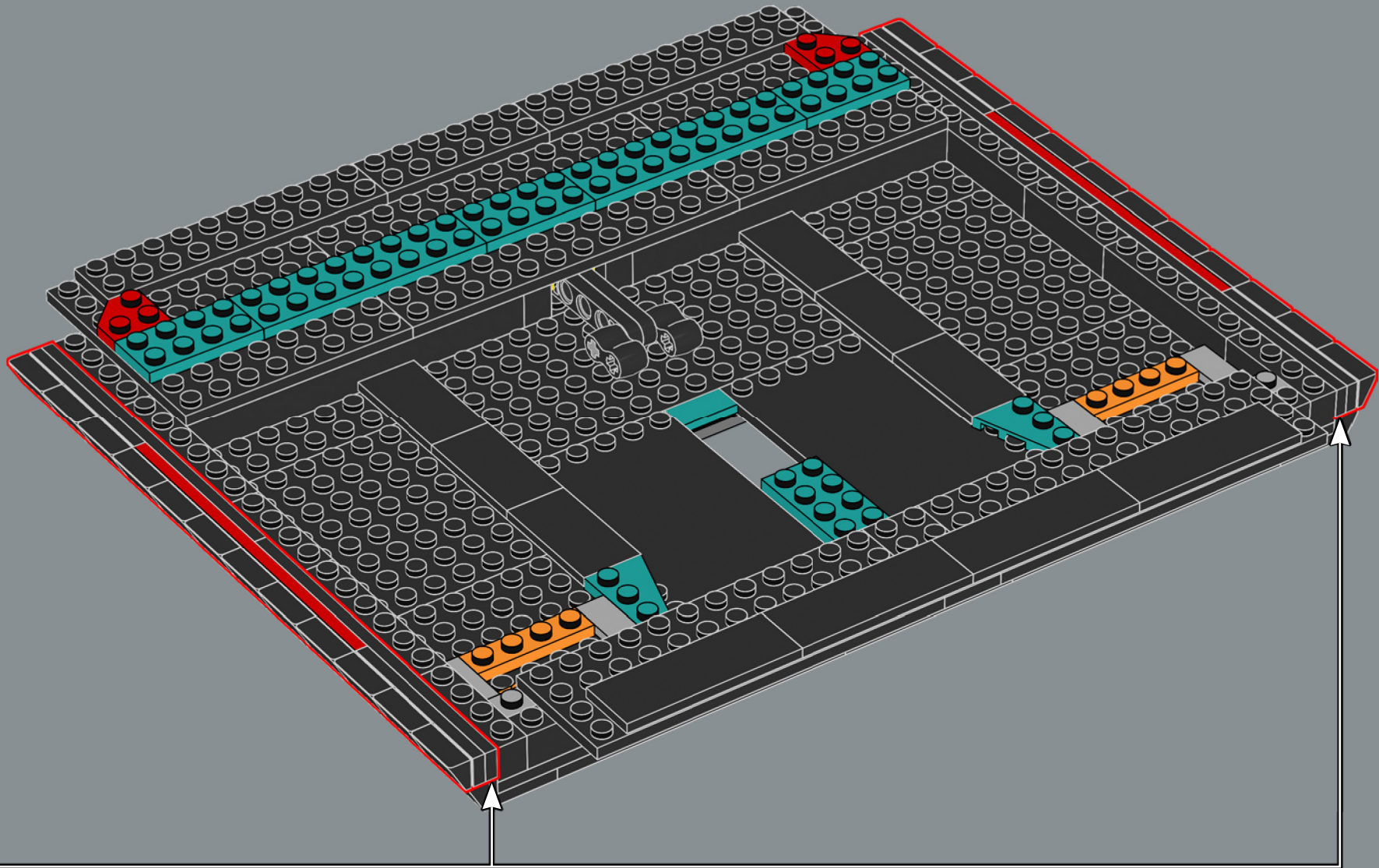

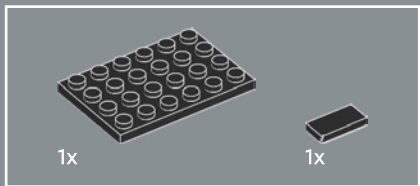
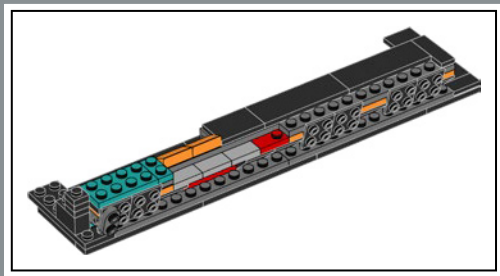

19

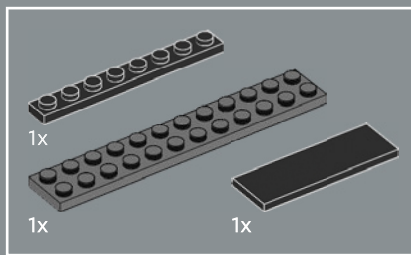
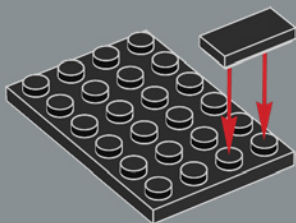

20

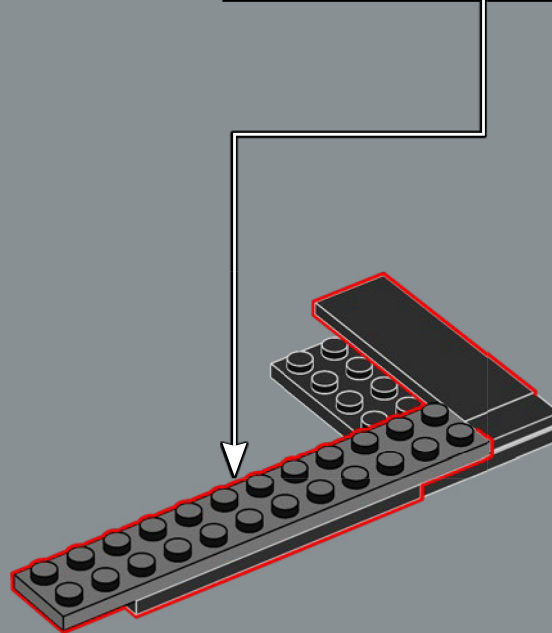
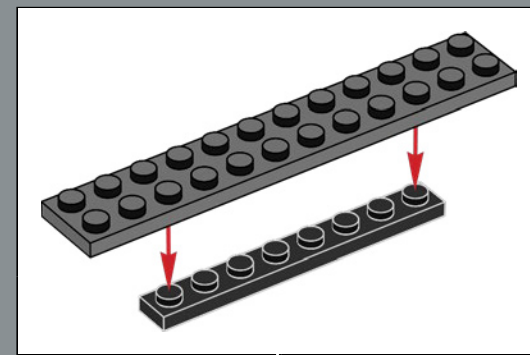

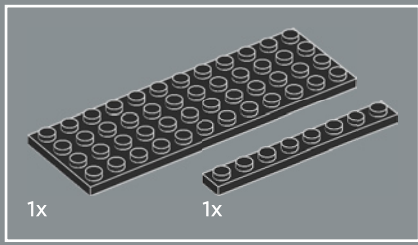

21

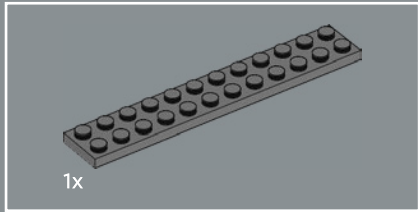
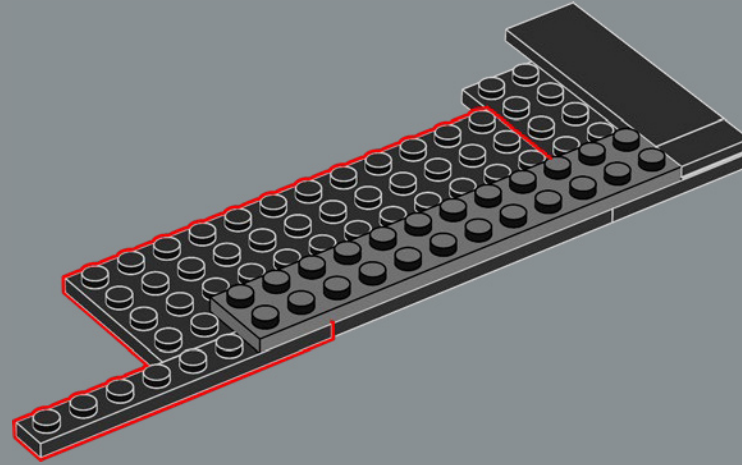

22

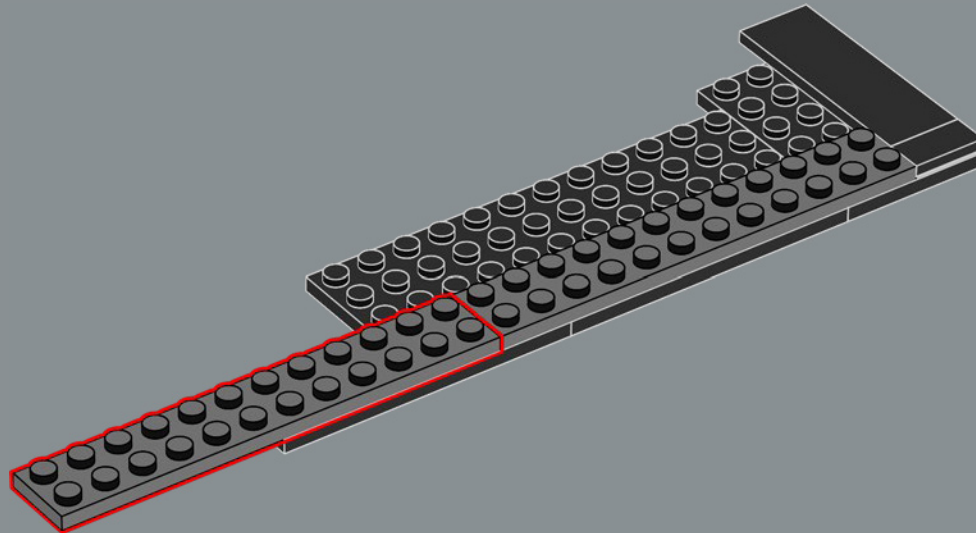

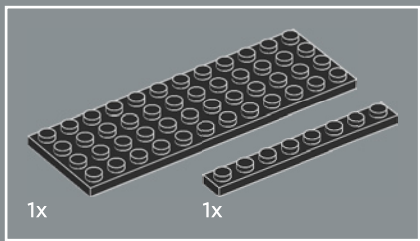

23

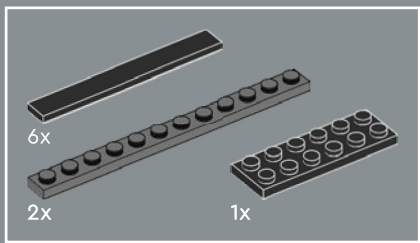
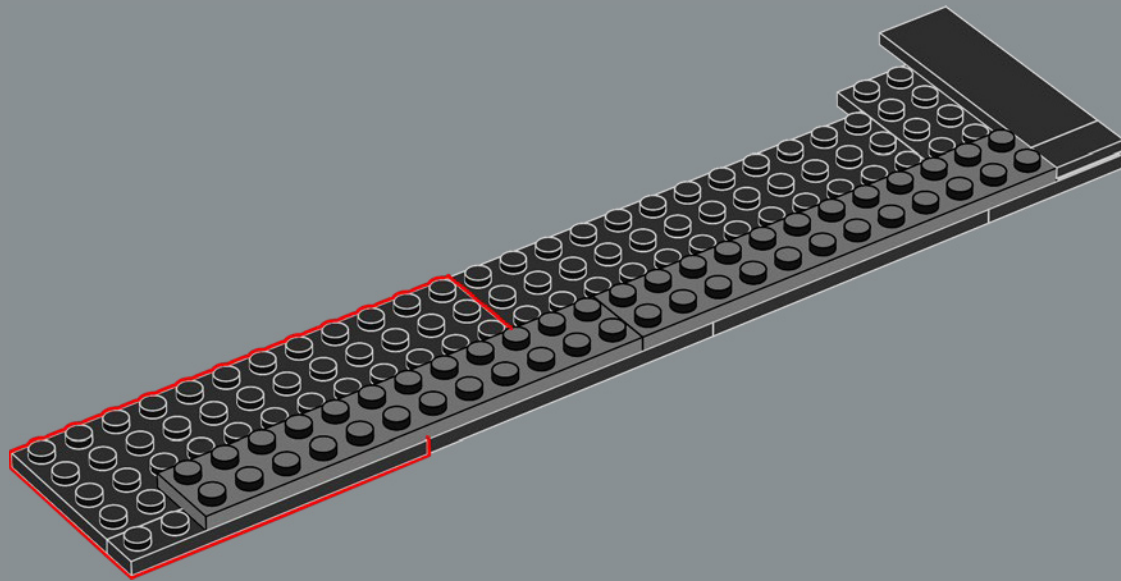

24

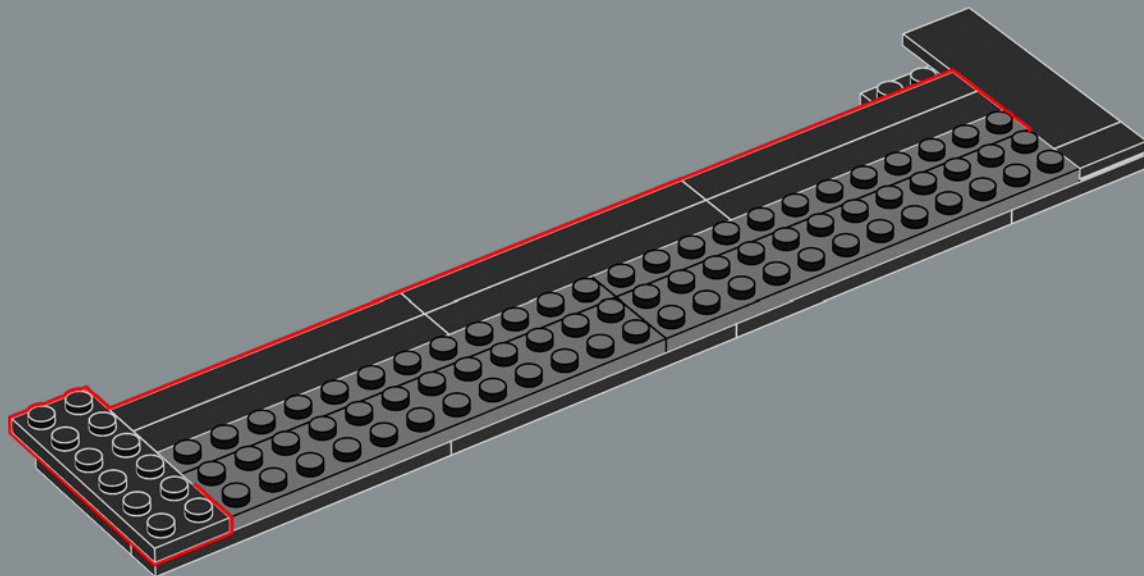

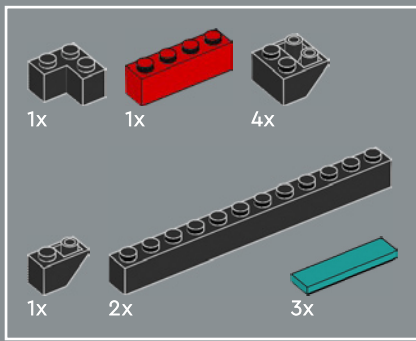

25

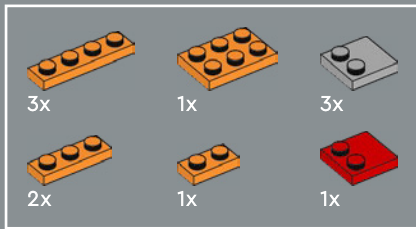
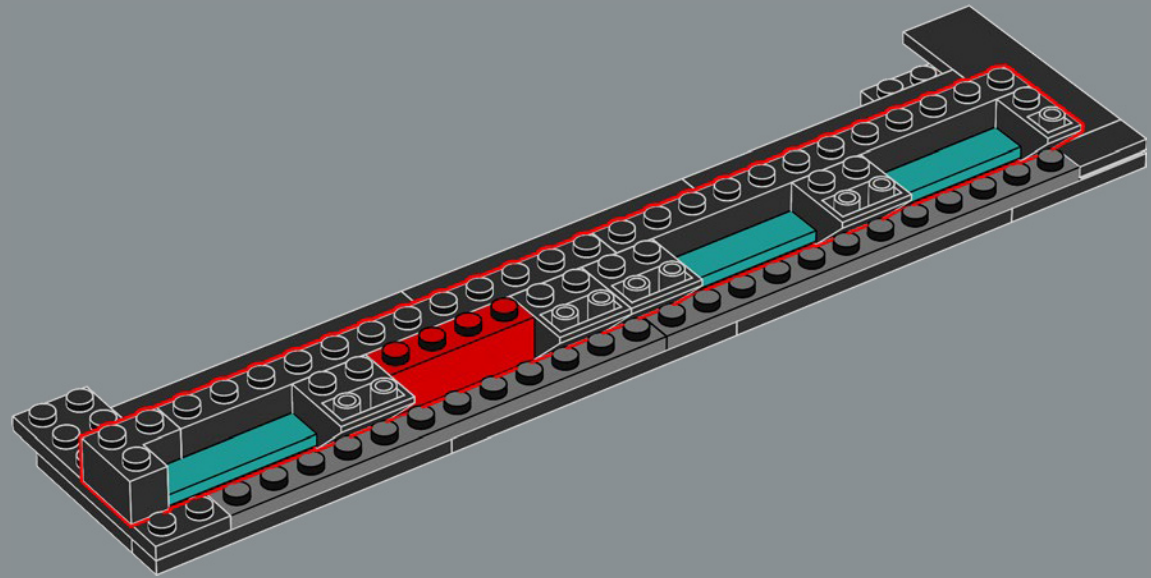

26

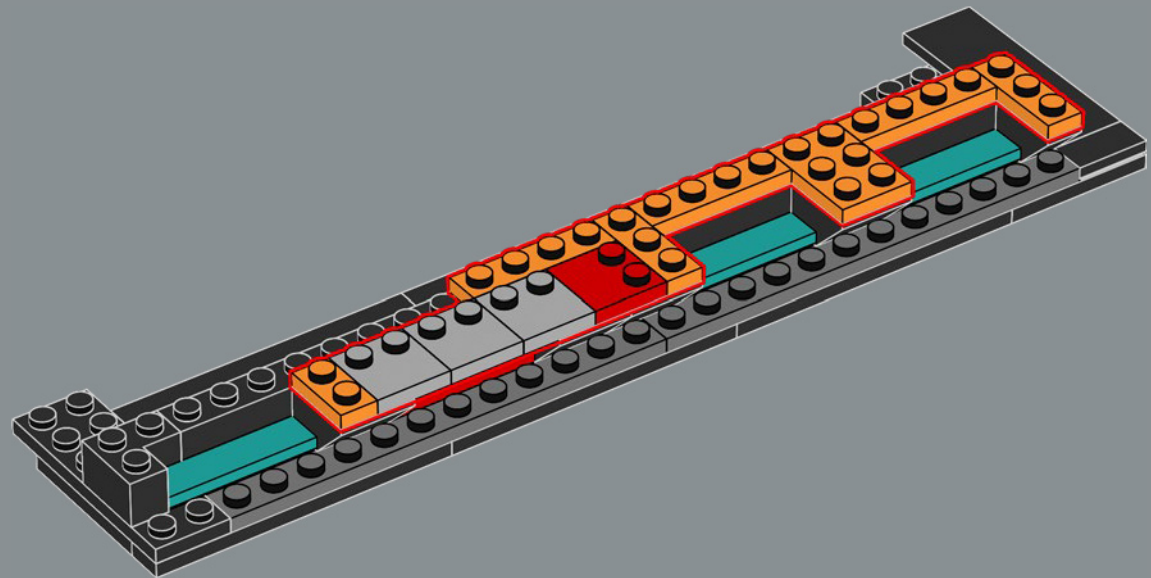

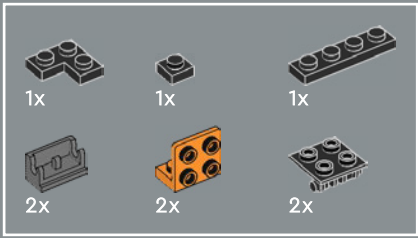

27

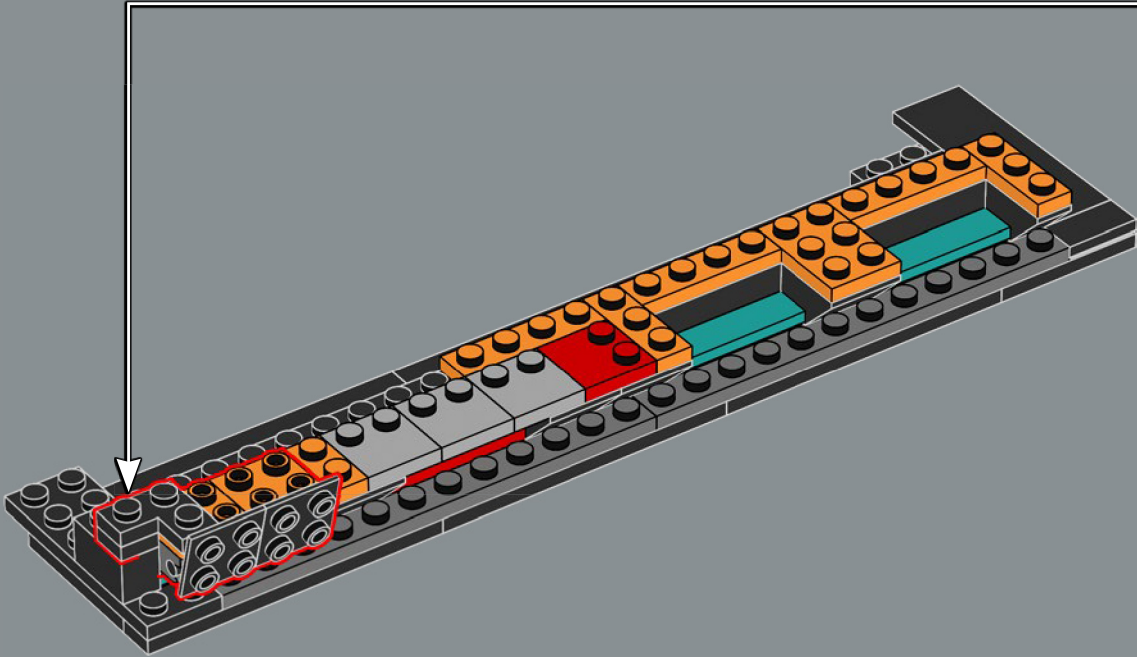
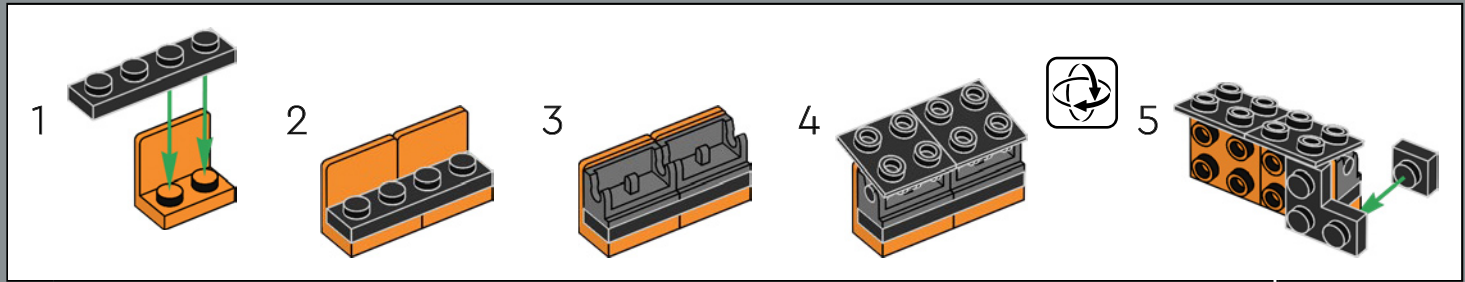

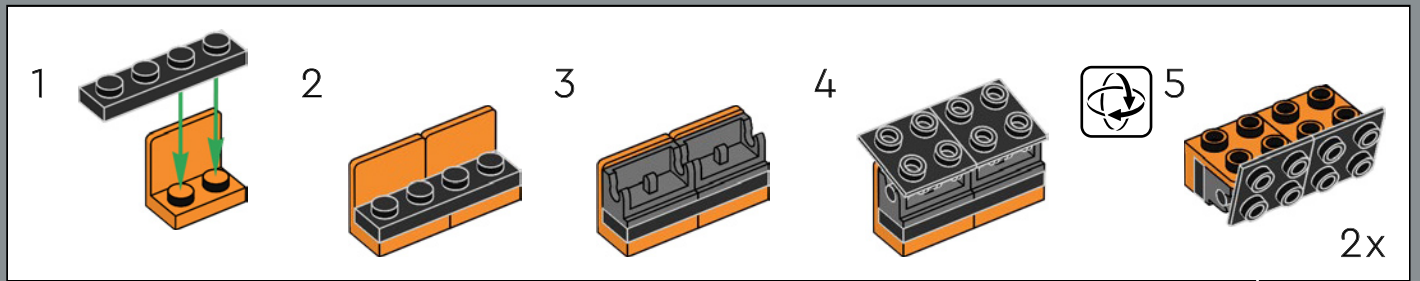
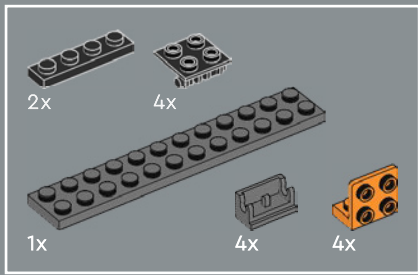

28

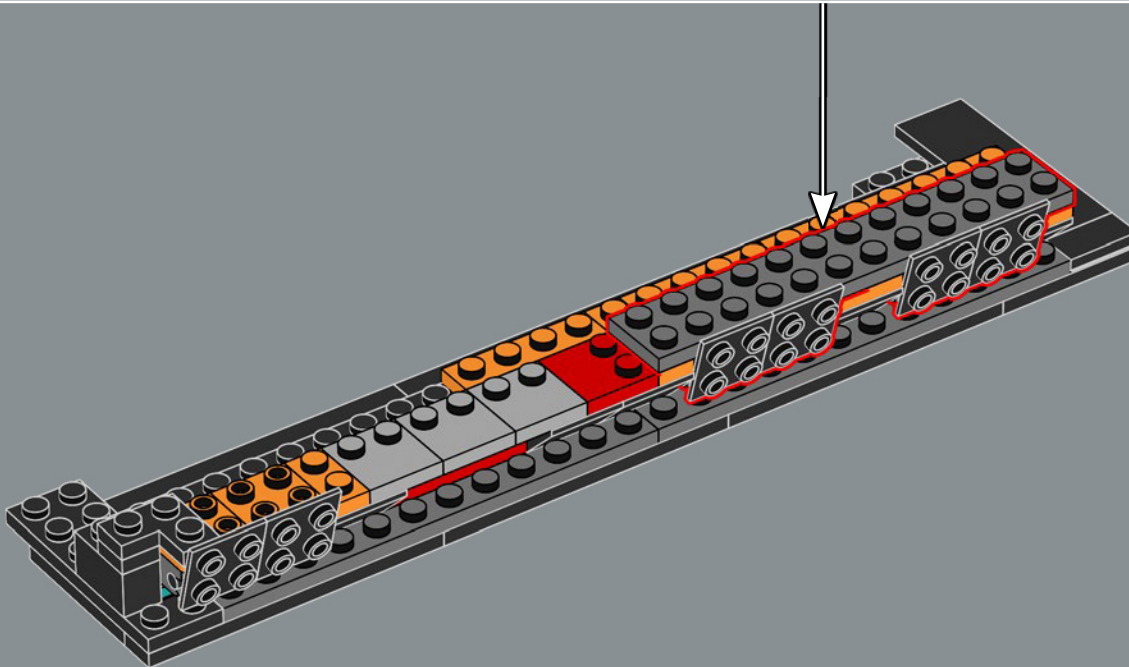
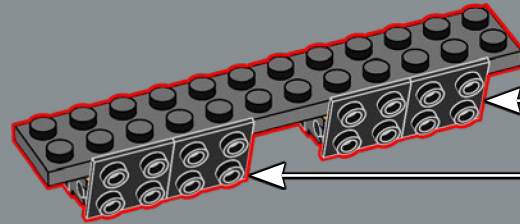

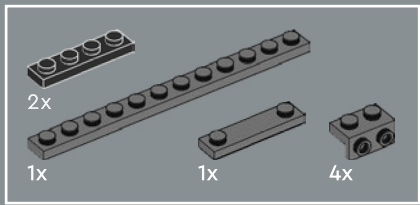

29

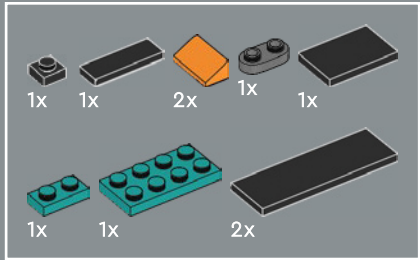
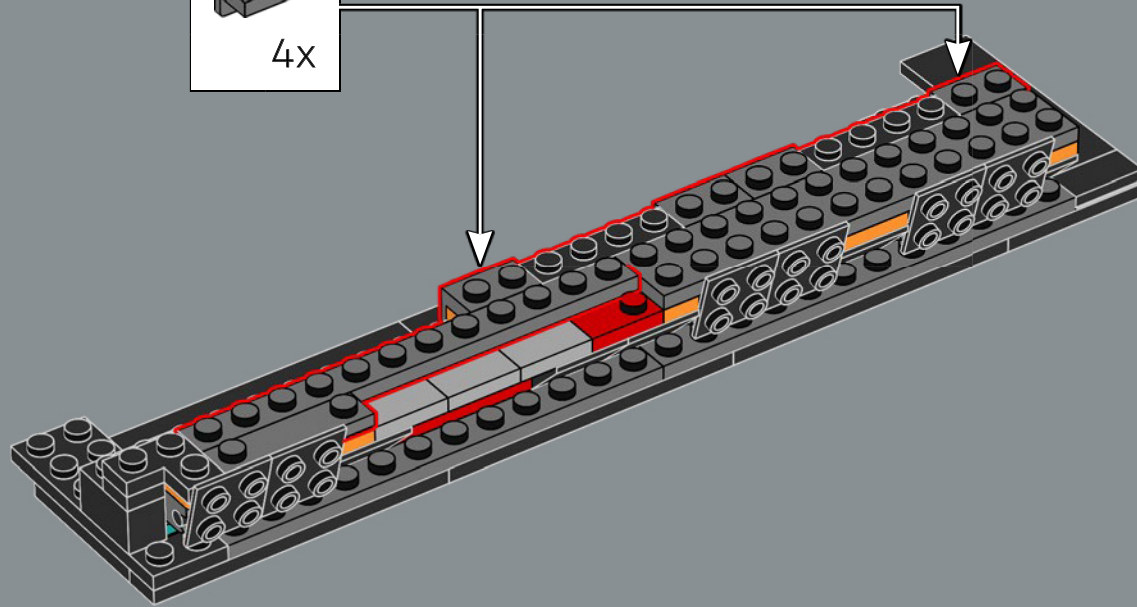
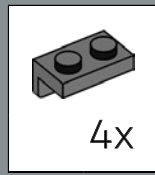

30

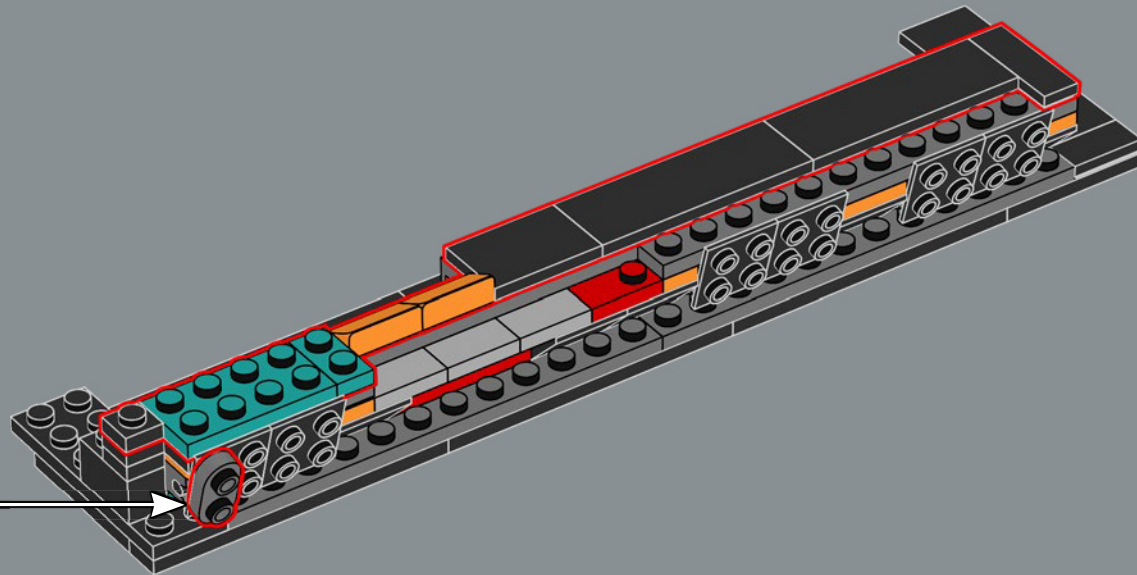

31

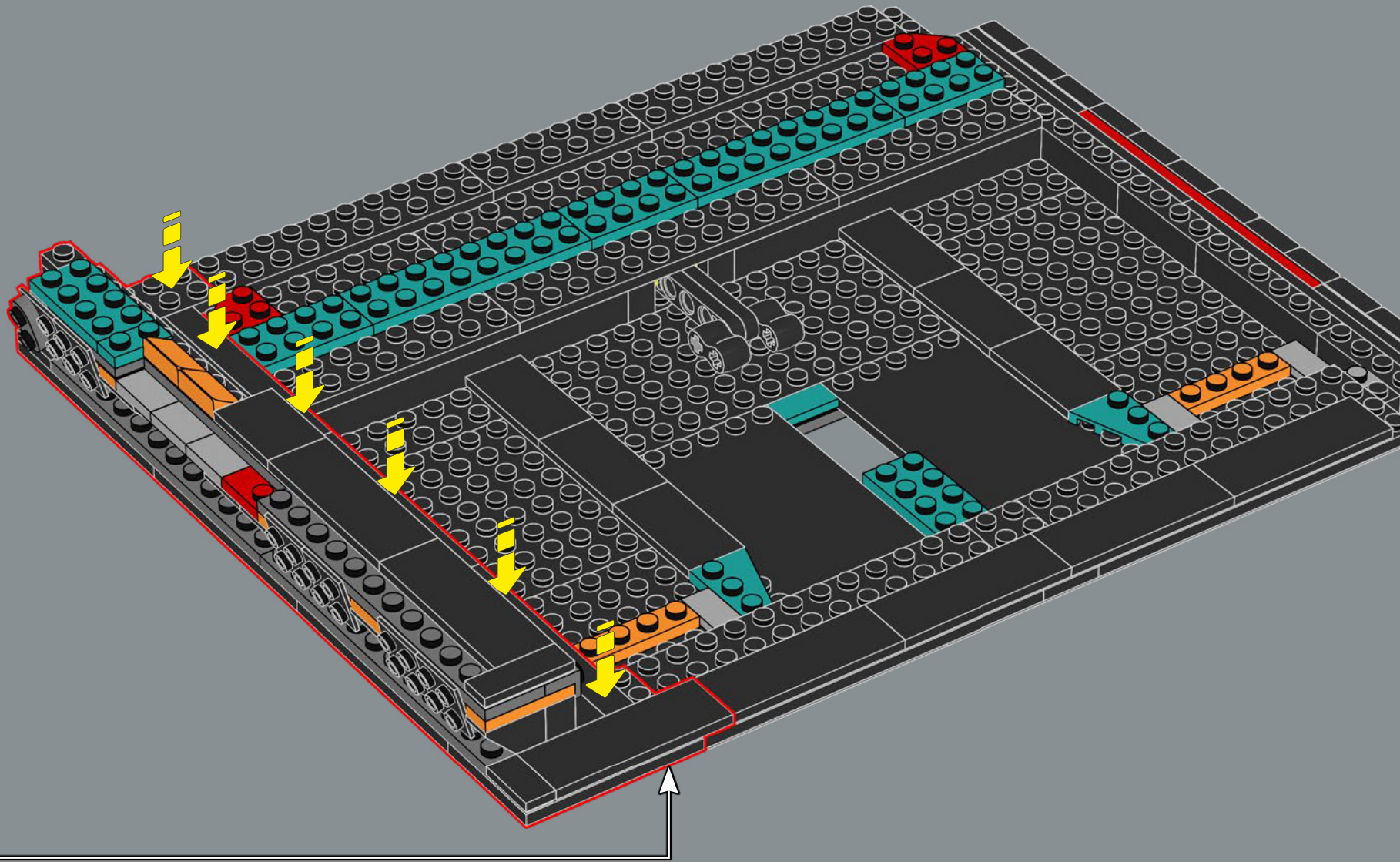

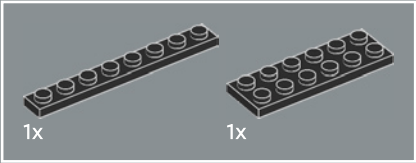
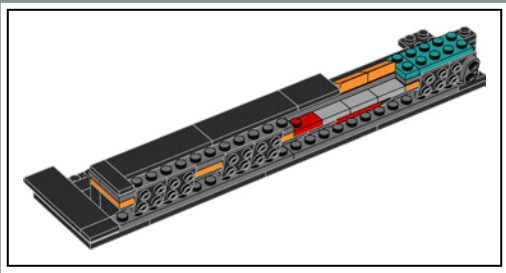

32

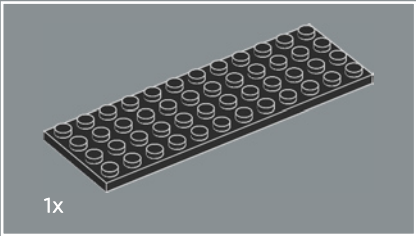
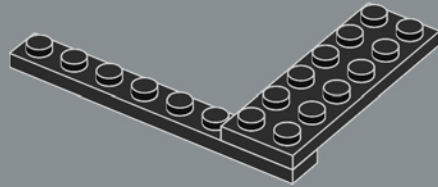

33

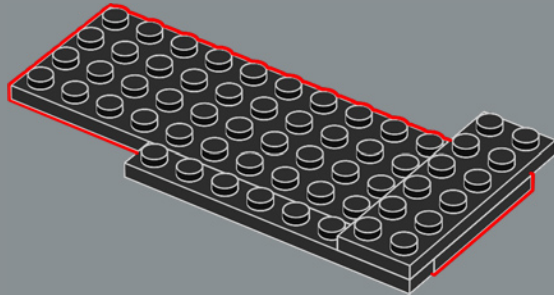

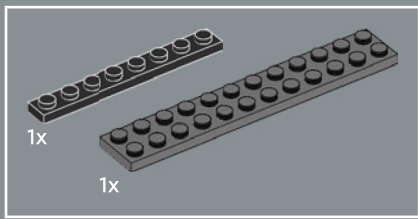

34

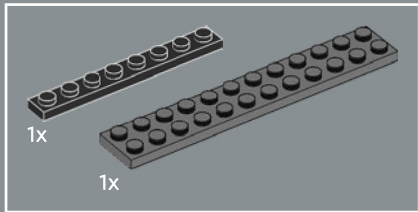
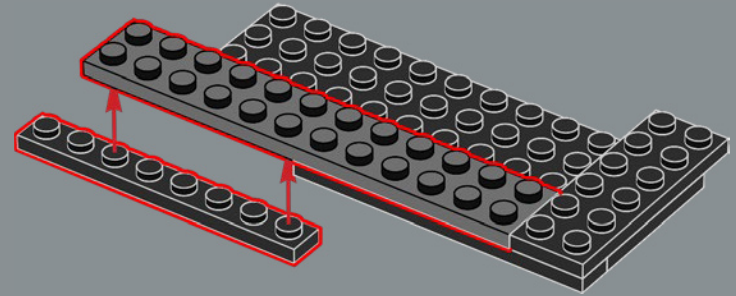

35

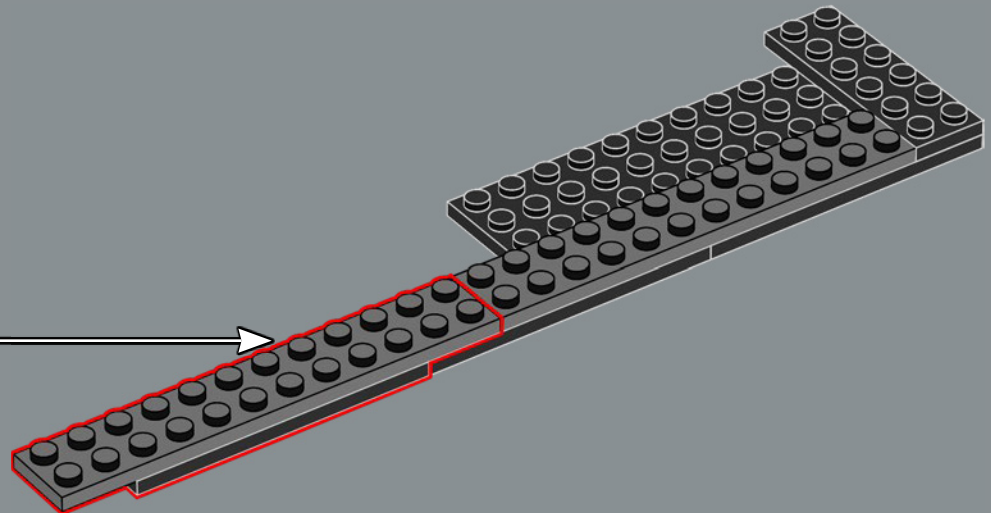
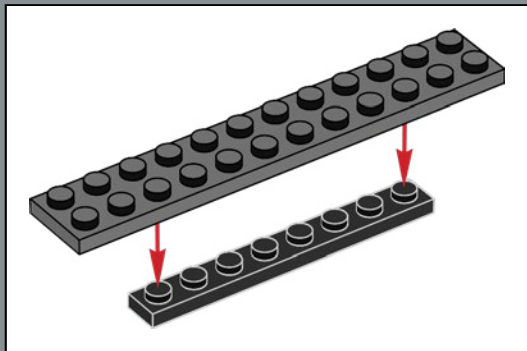

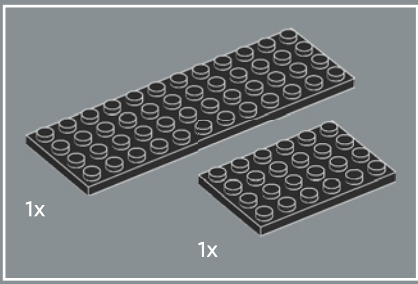

36

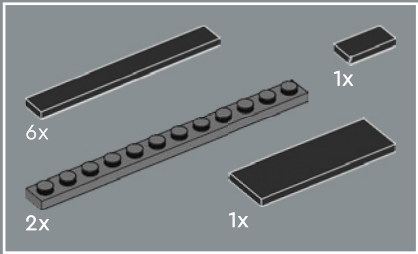
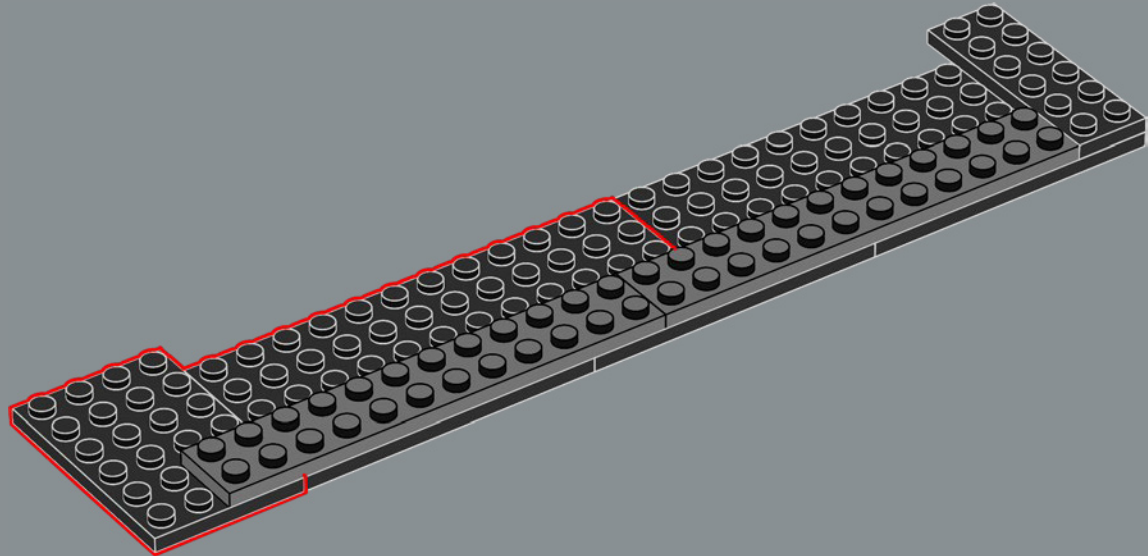

37

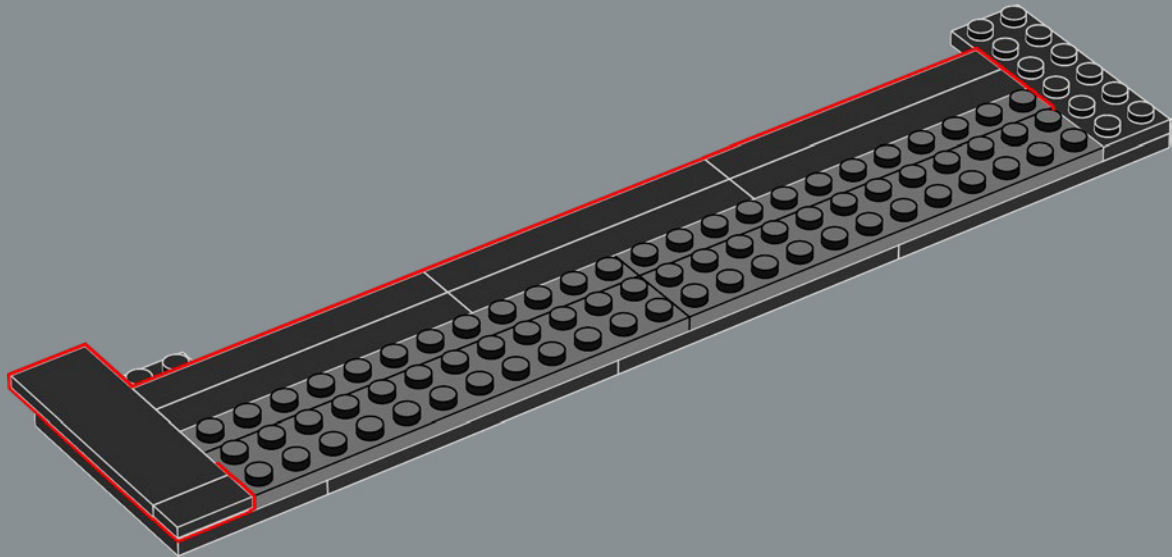

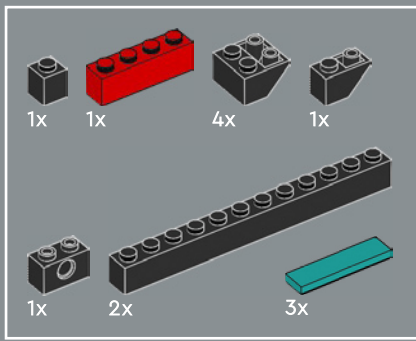

38

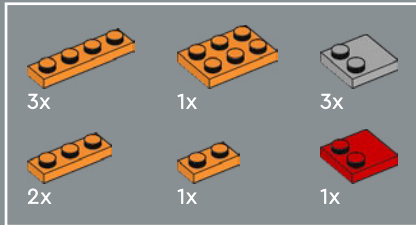
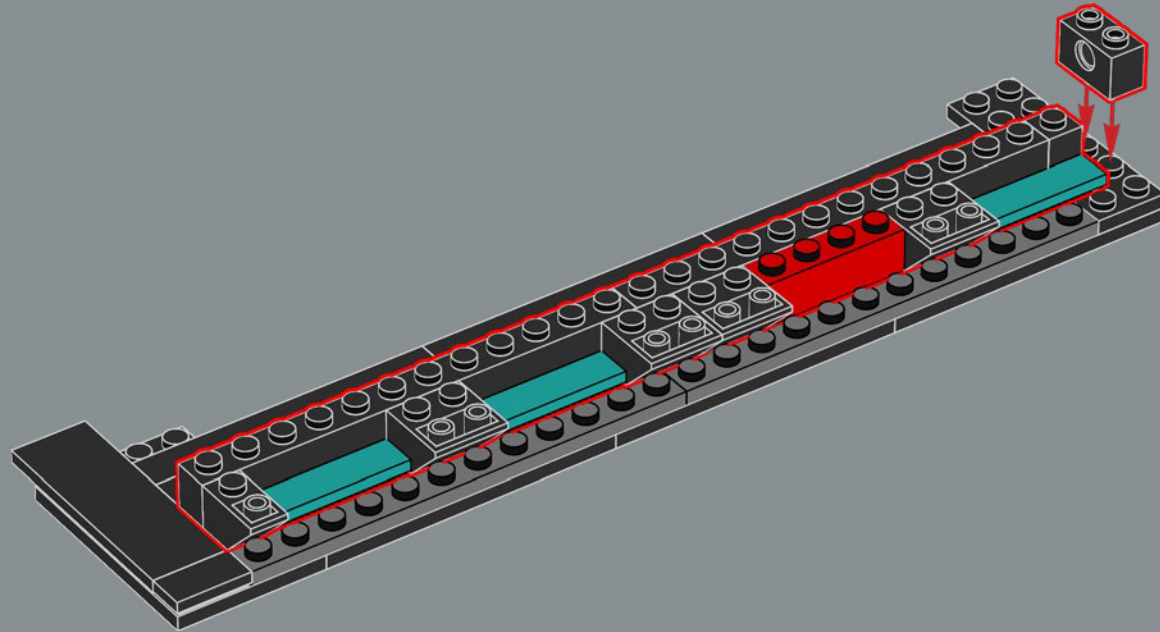

39

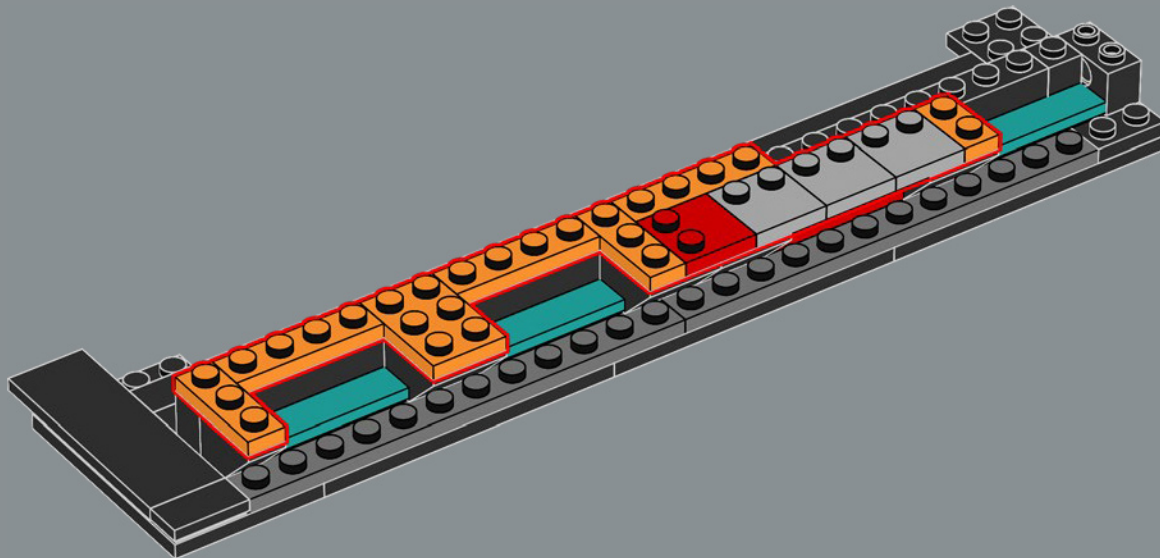

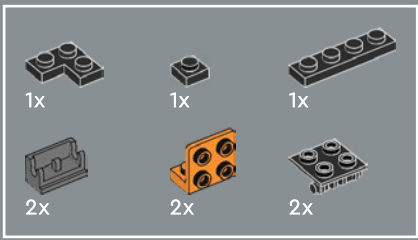

40

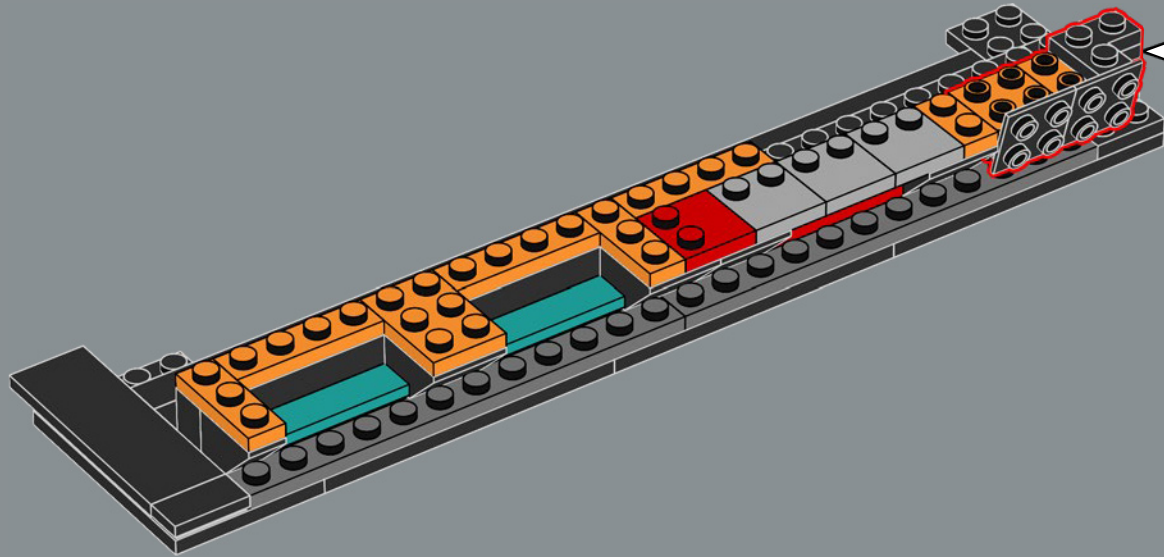
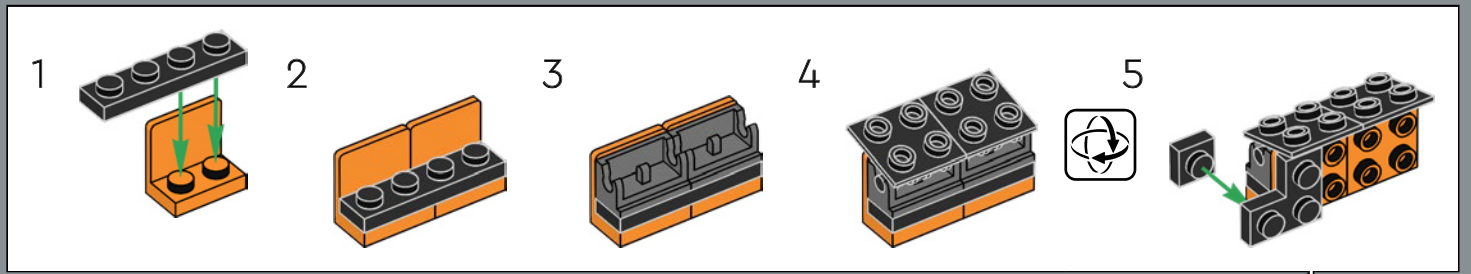

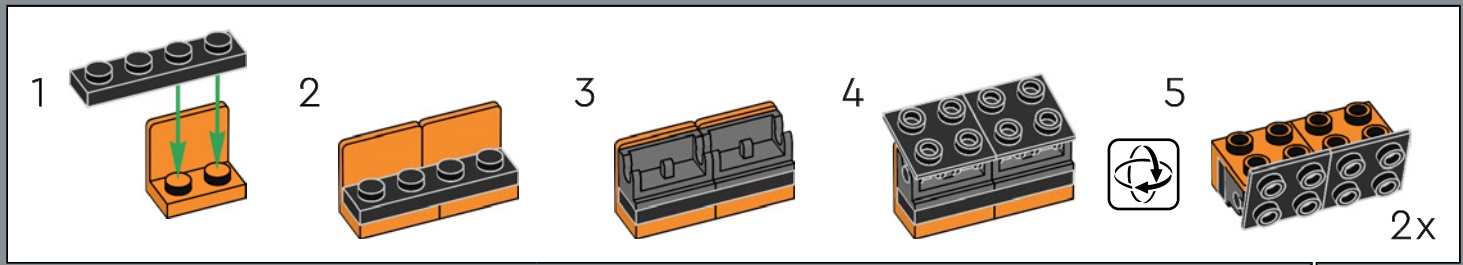
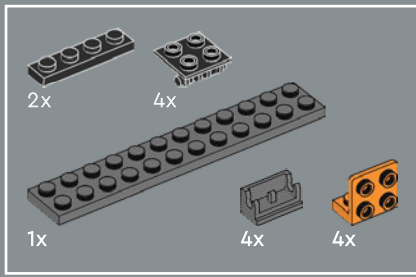

41

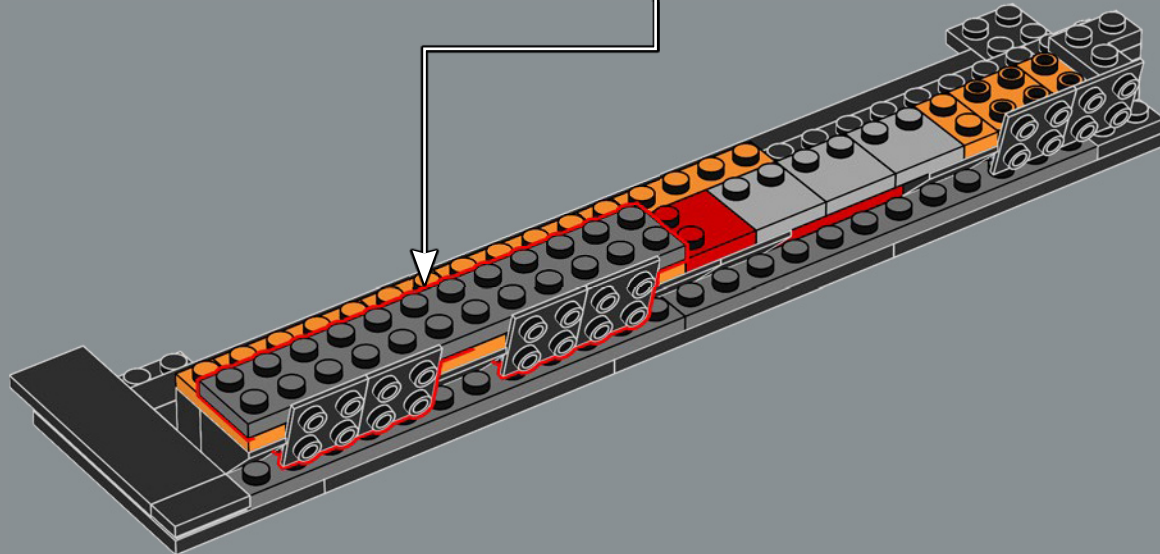
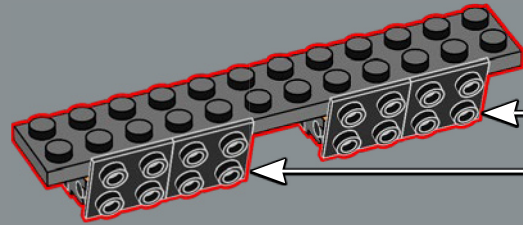

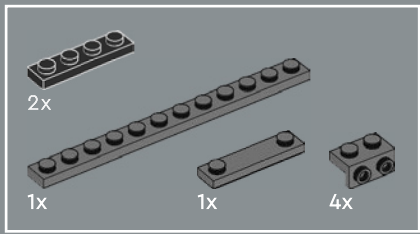

42

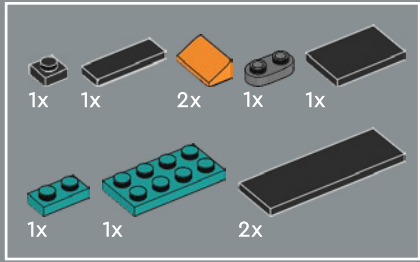
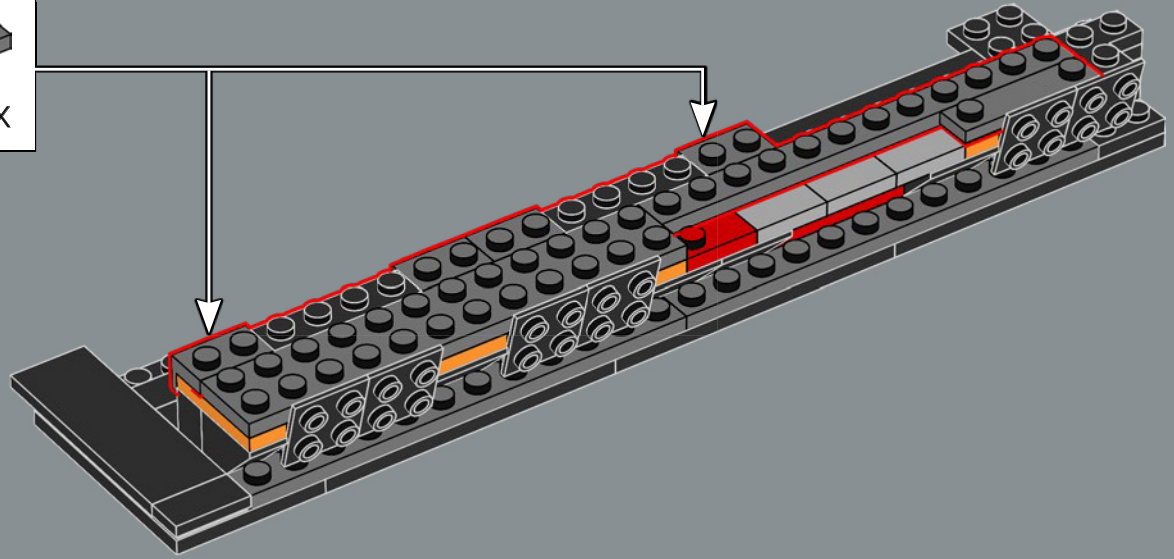
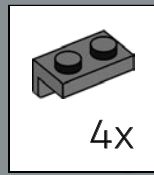

43

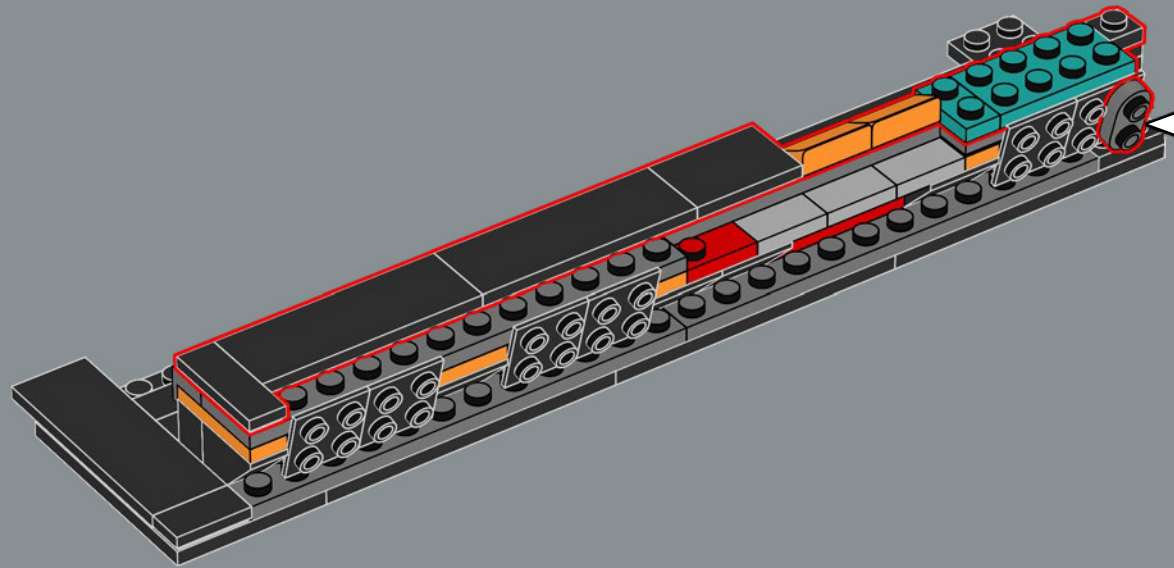
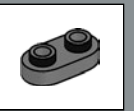

44

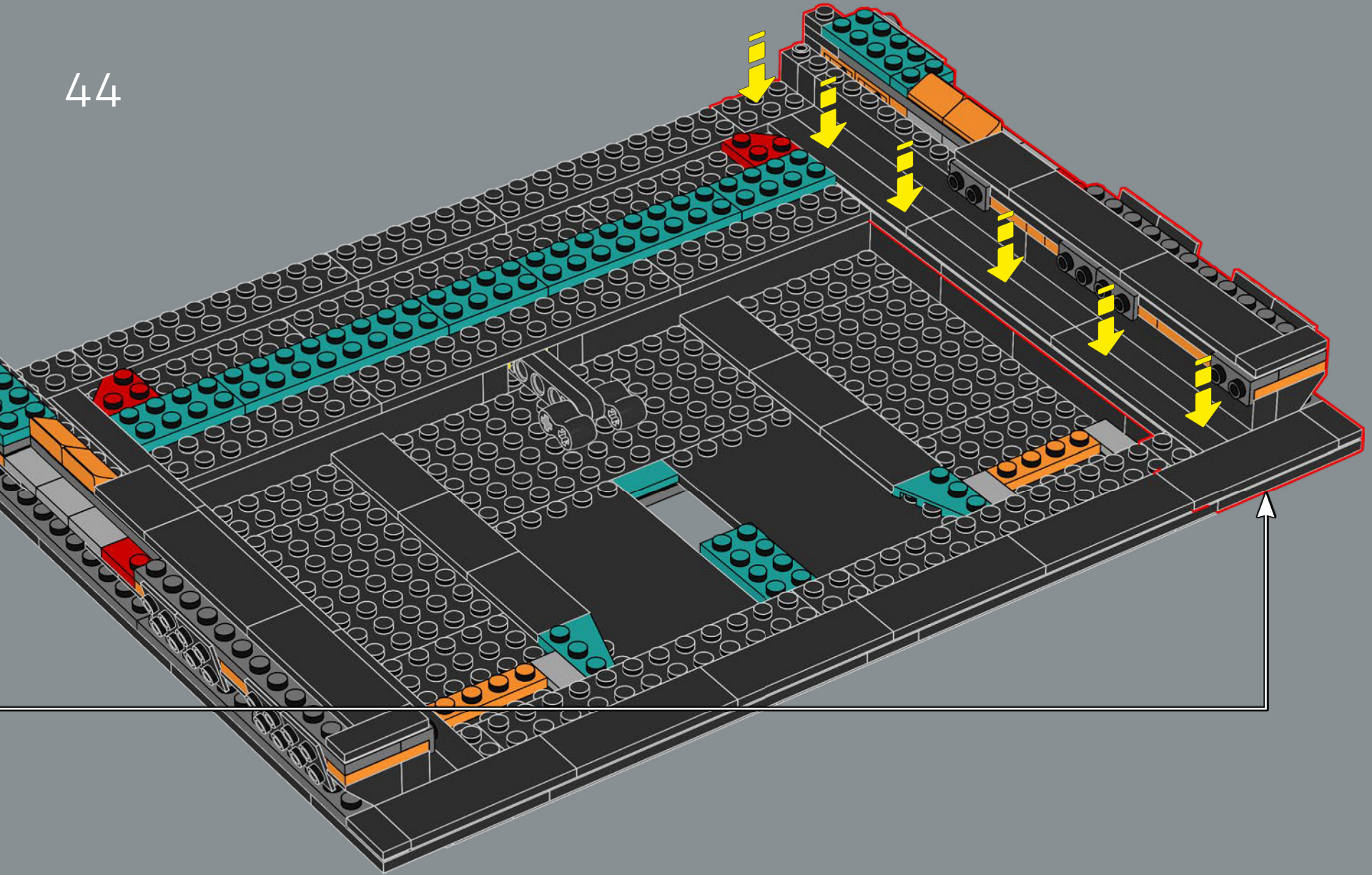



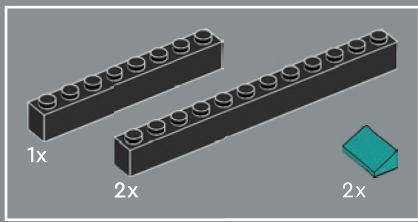

45

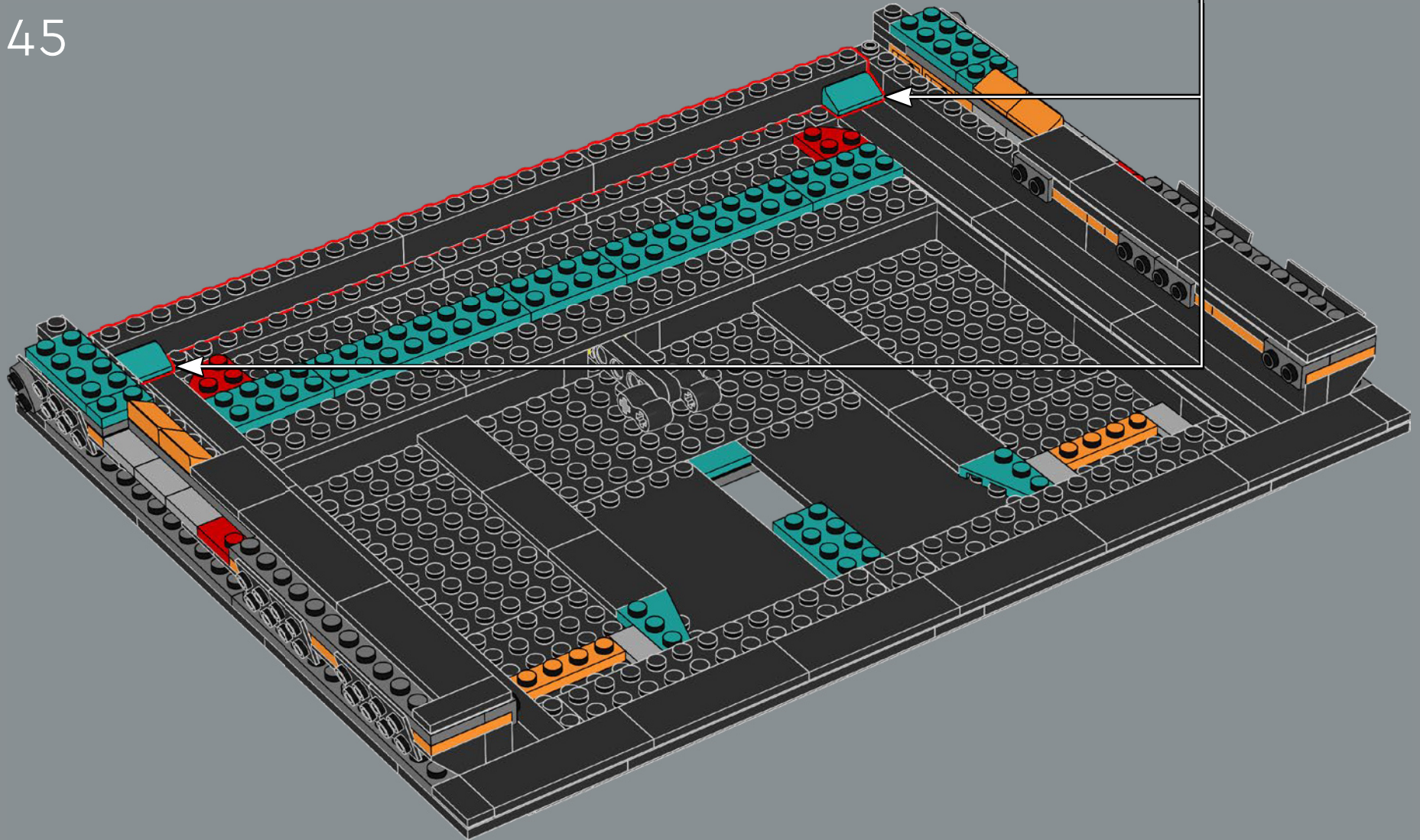
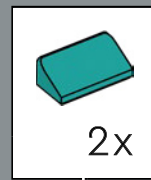

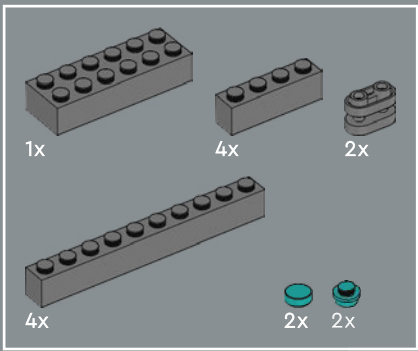

46

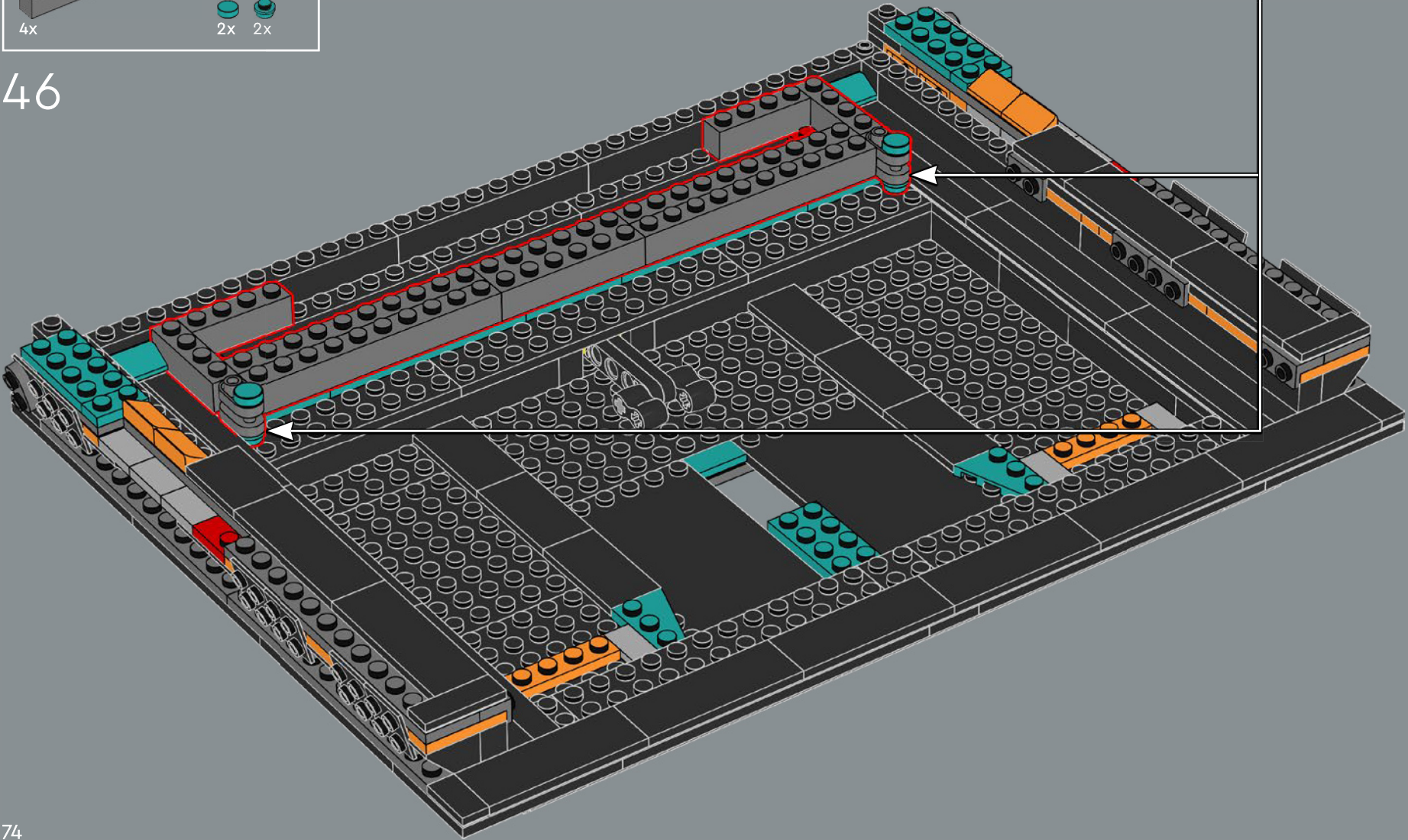
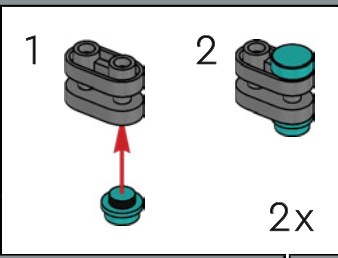

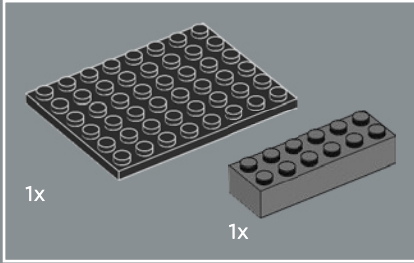
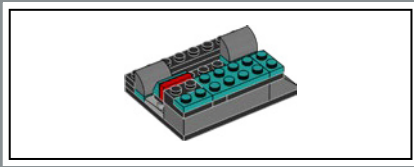

47

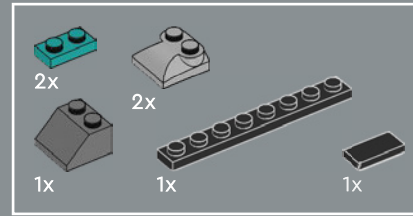
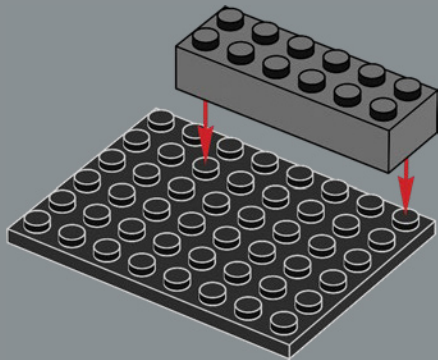

48

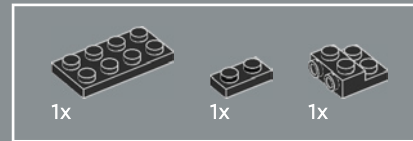
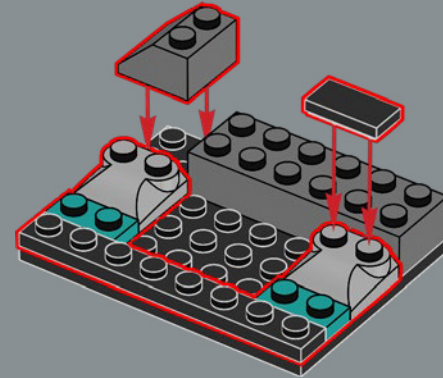

49

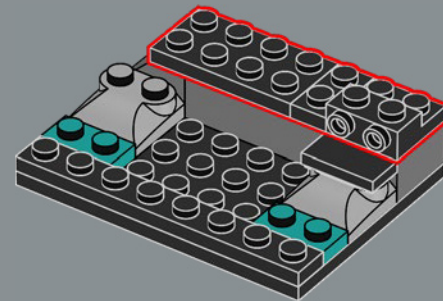

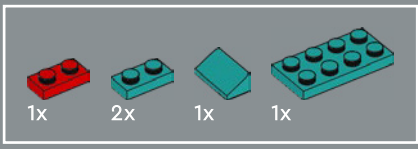

50

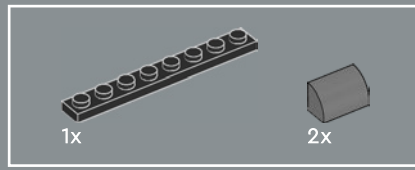
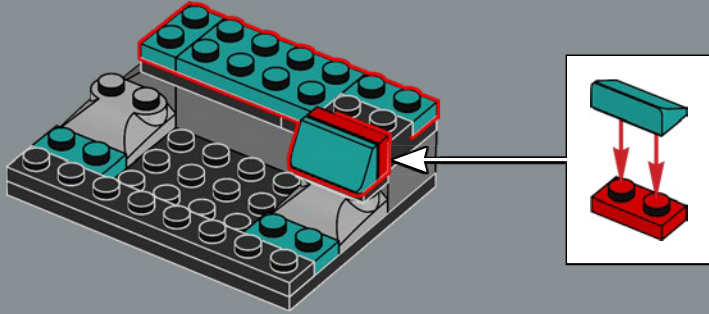

51

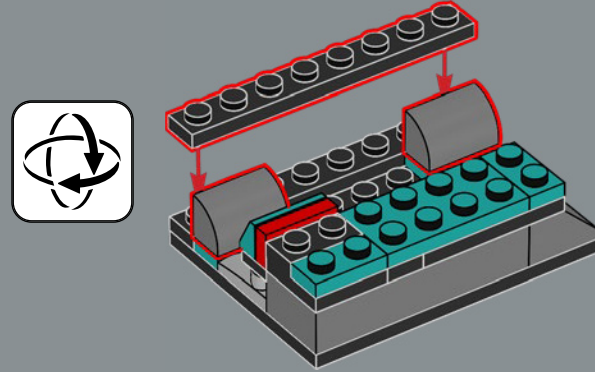

52

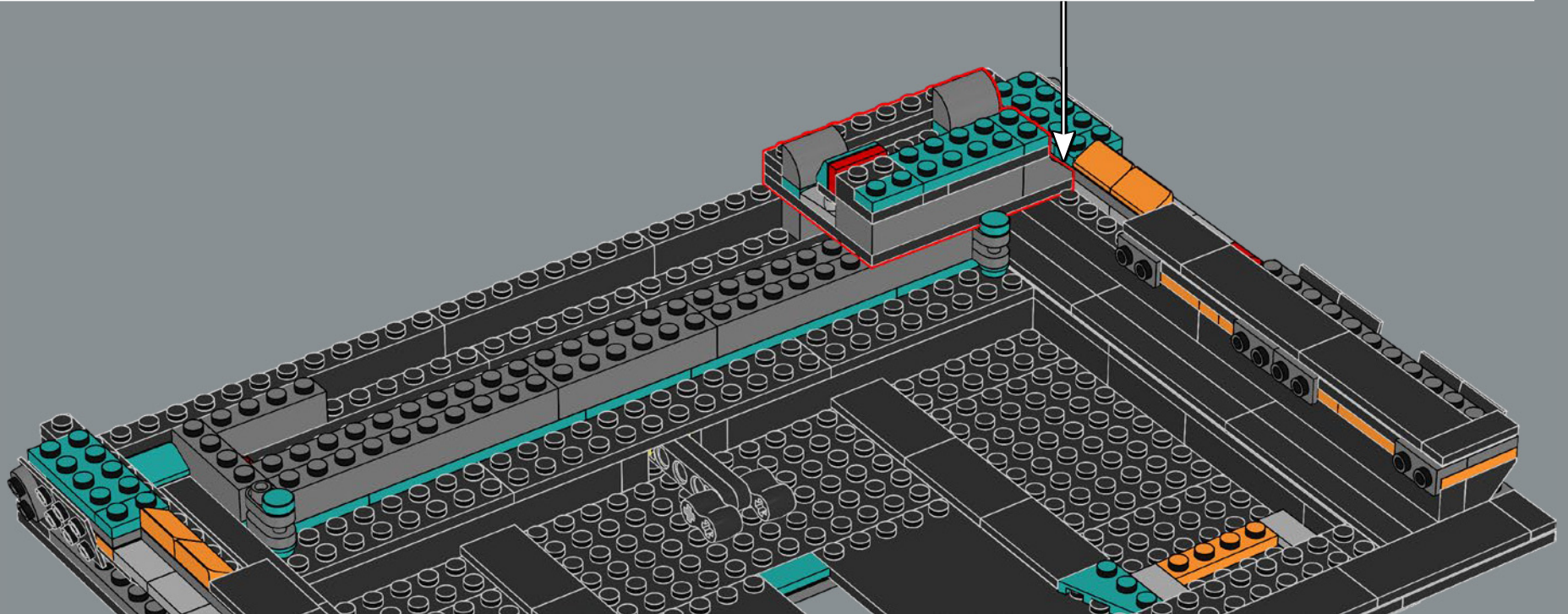

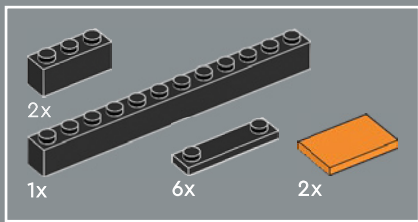

53

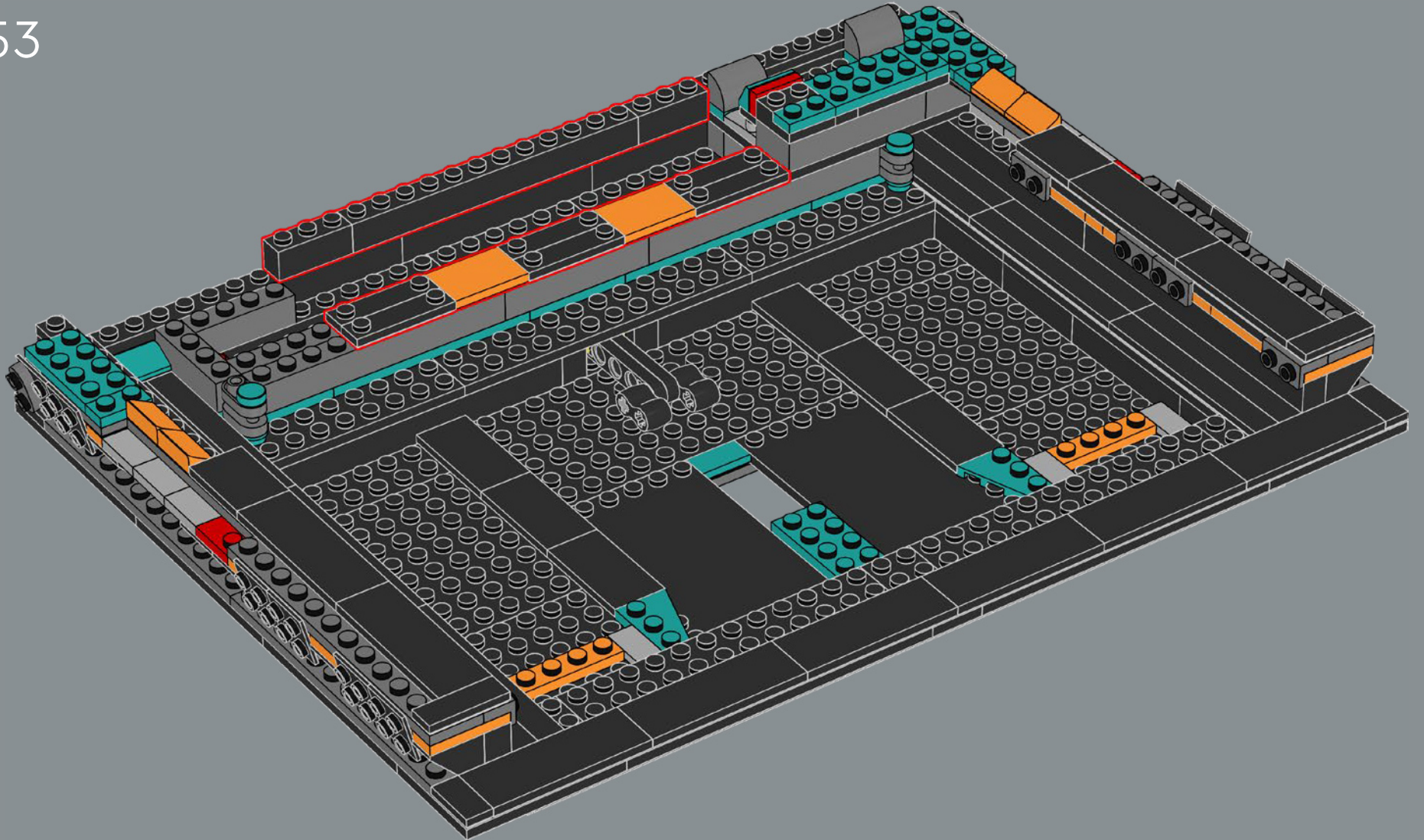

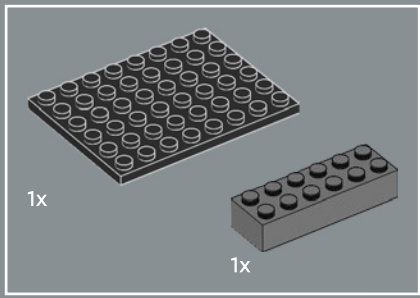

54

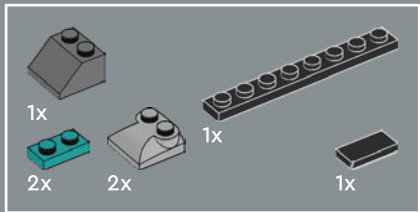
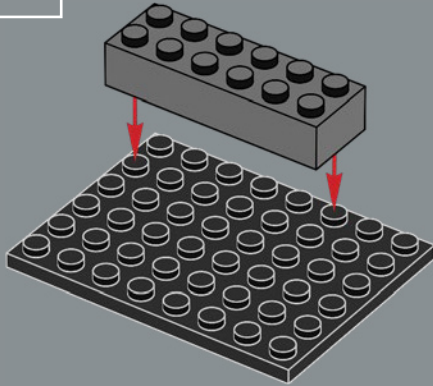

55

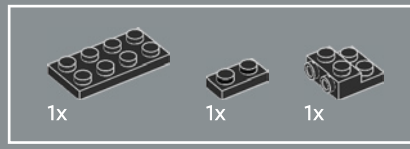
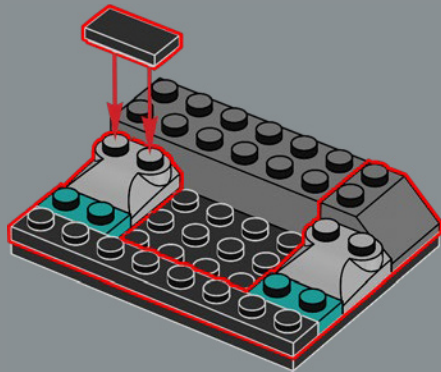

56

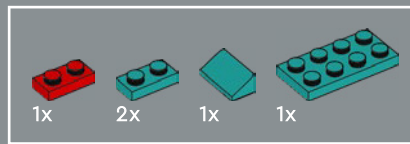
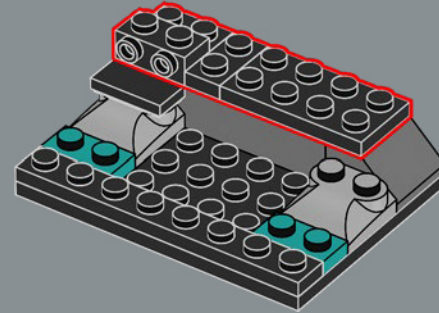

57

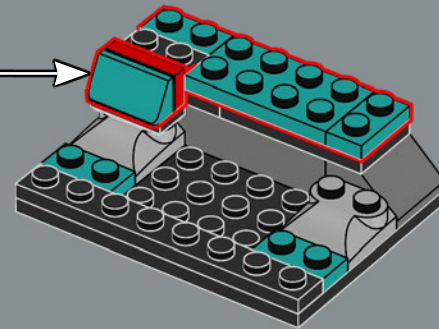
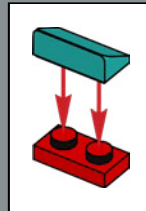

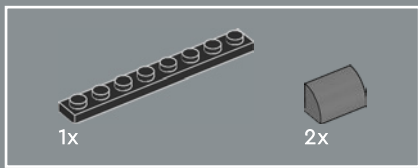

58

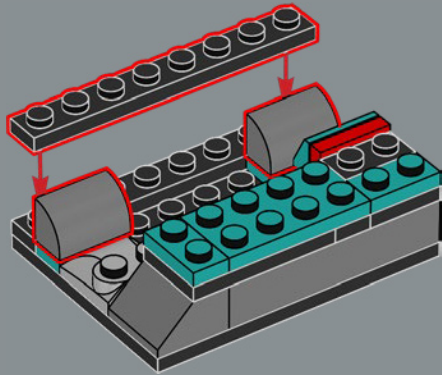

59

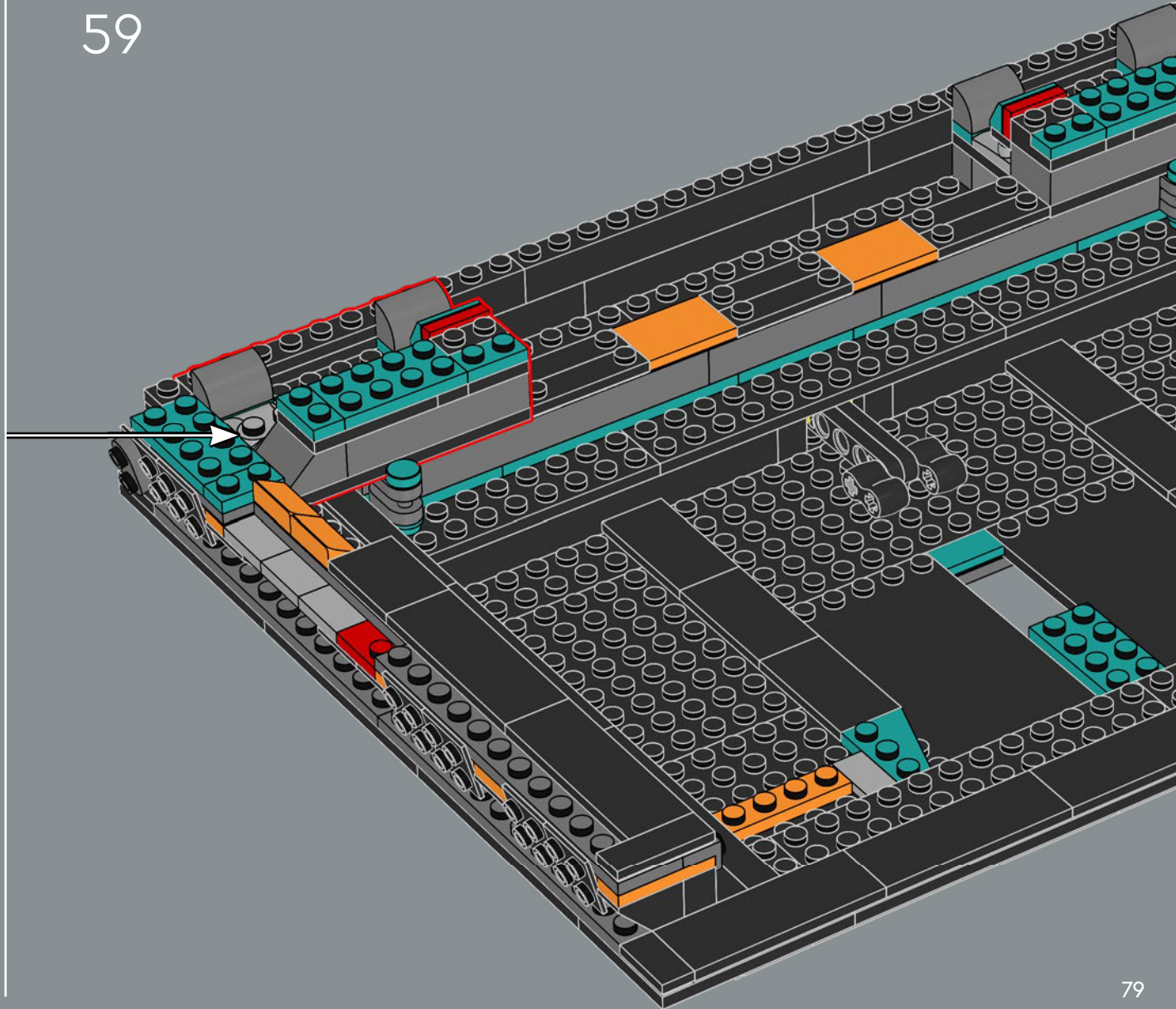

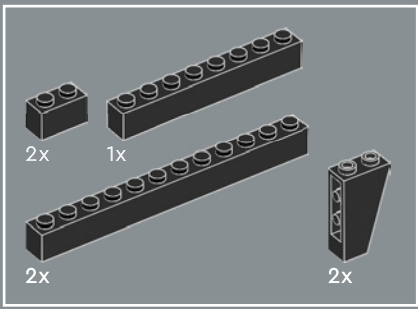

60

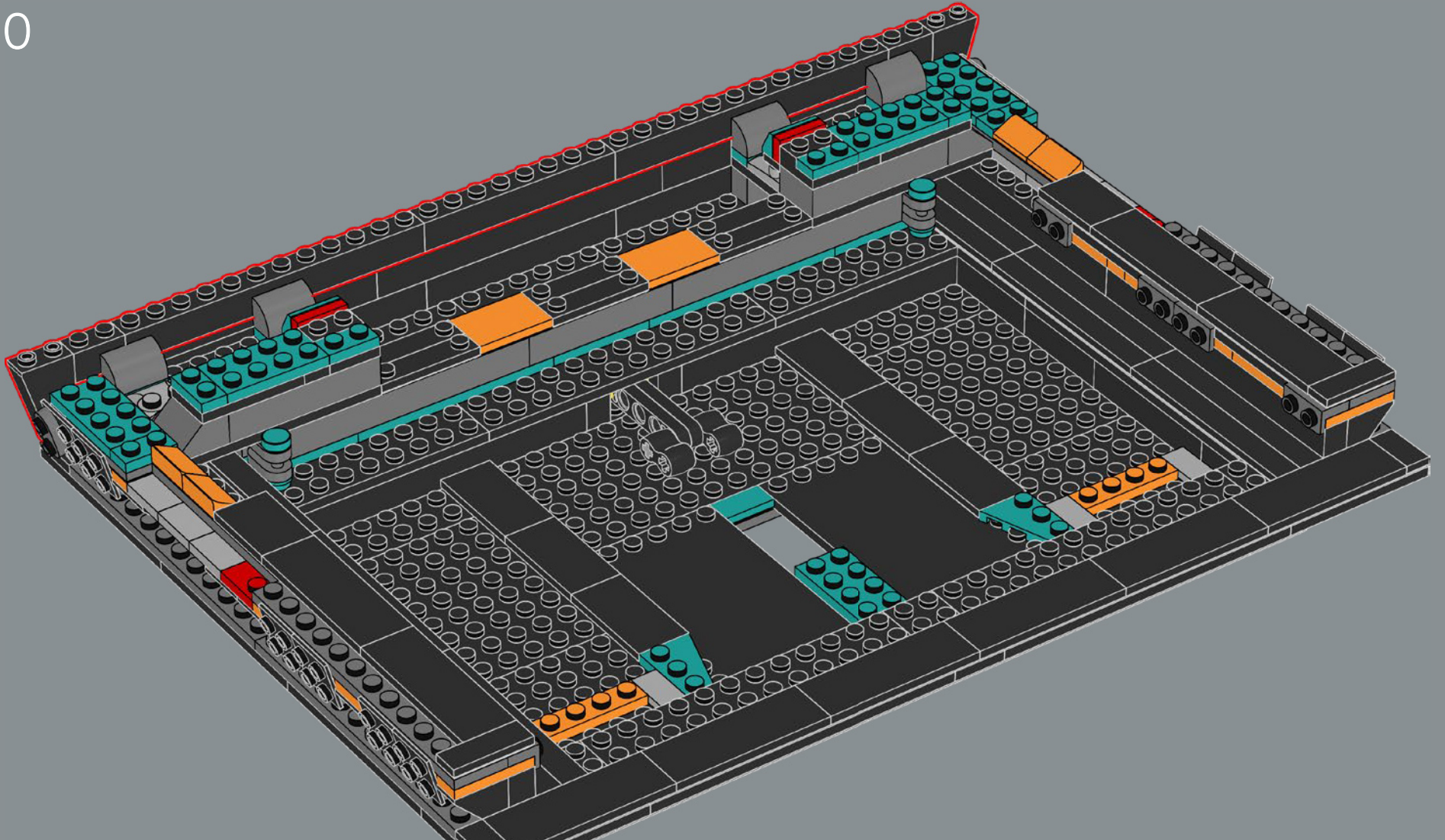

80

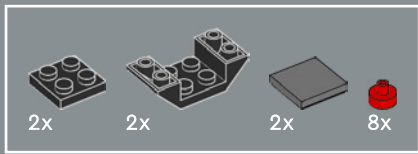

61

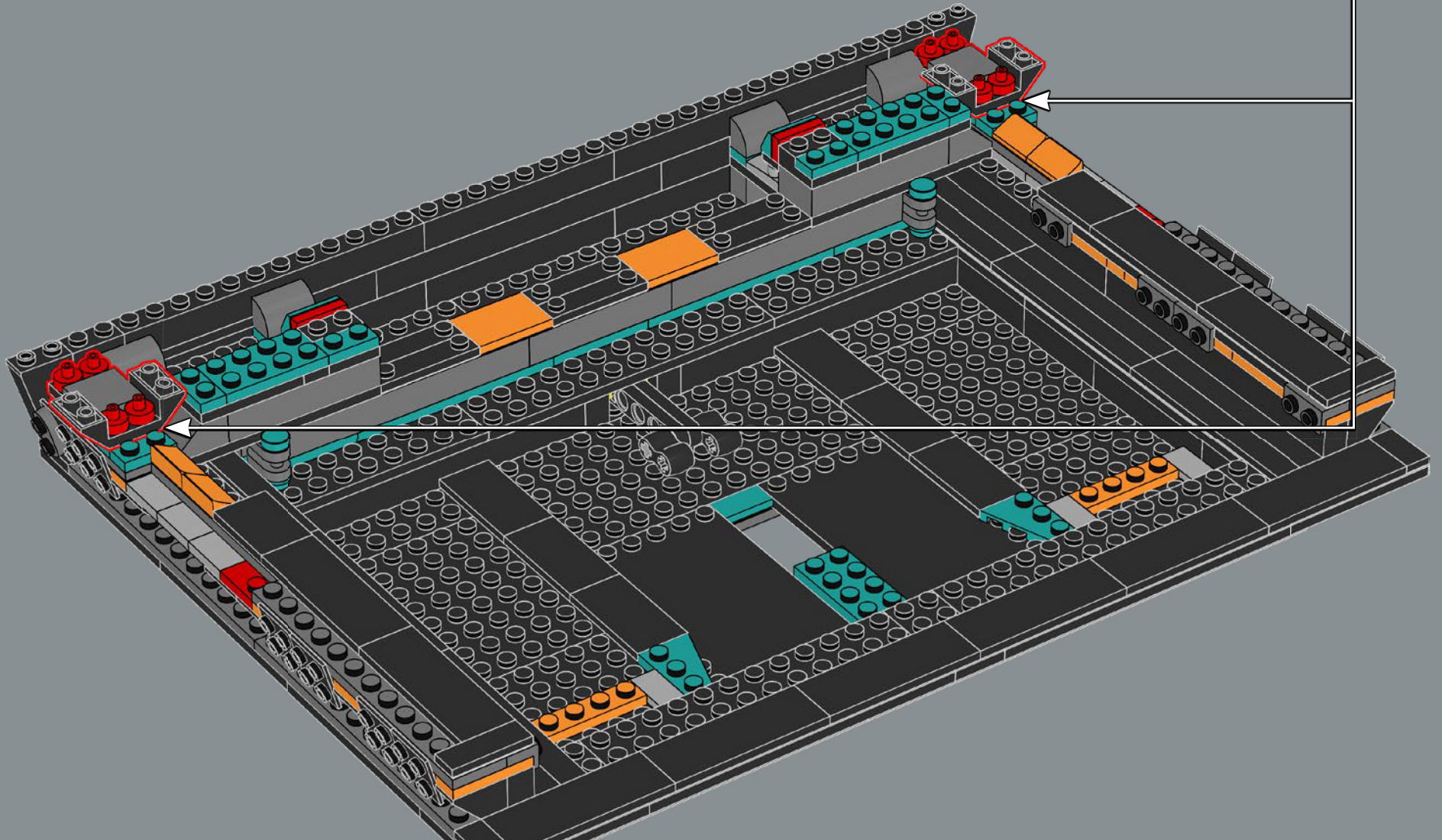
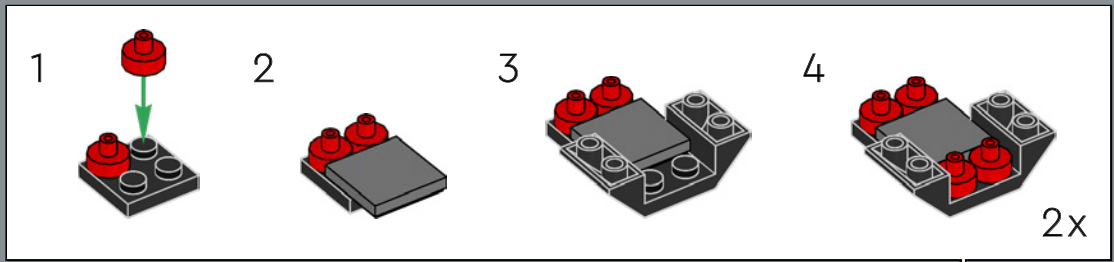

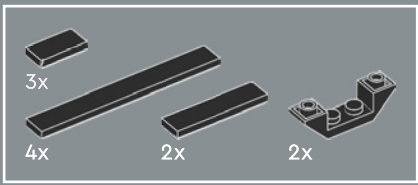

62

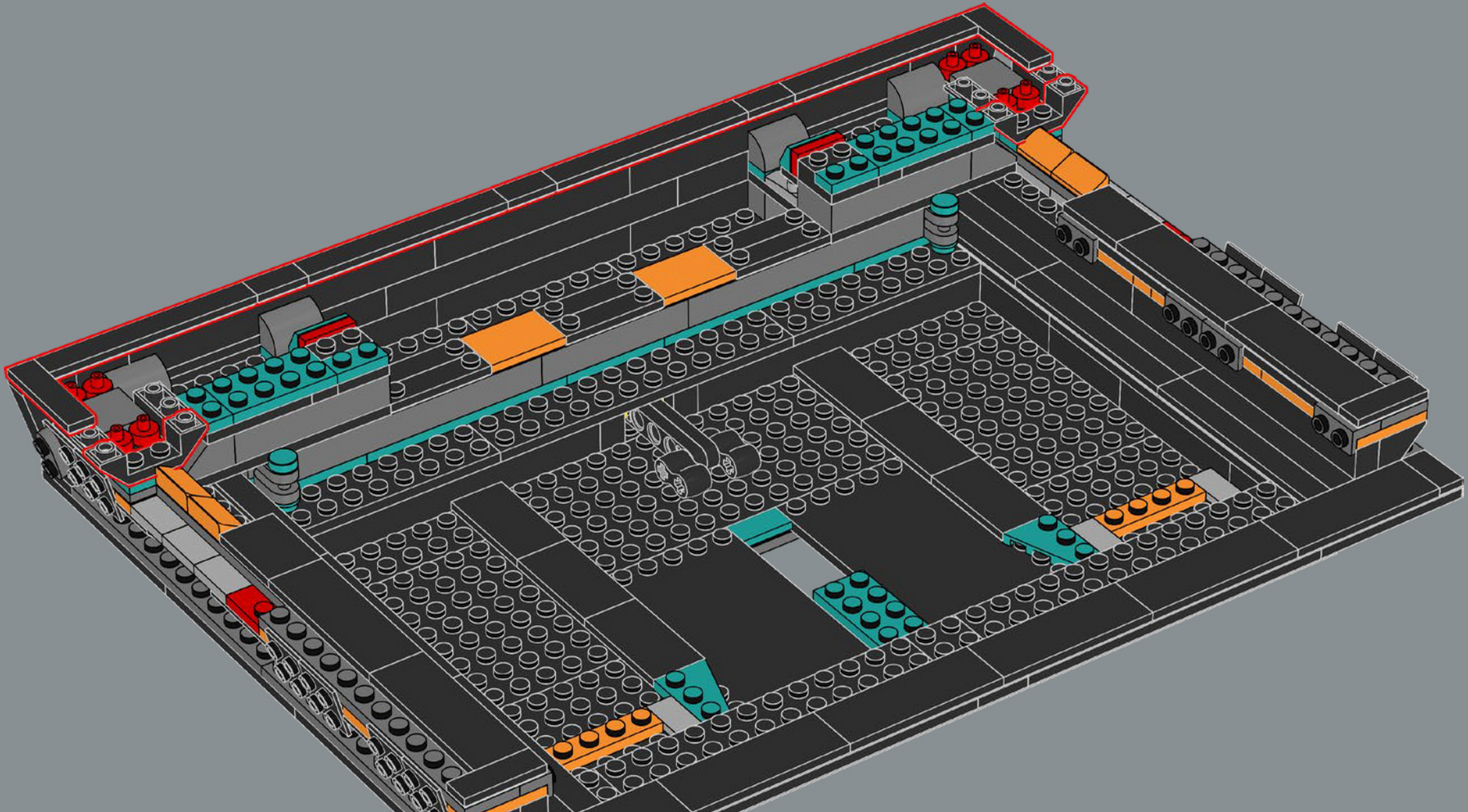

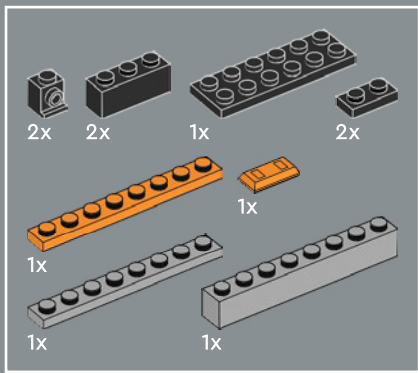

63

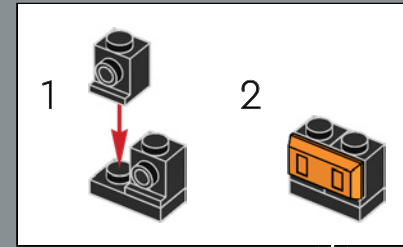
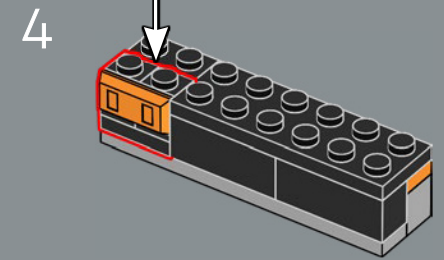
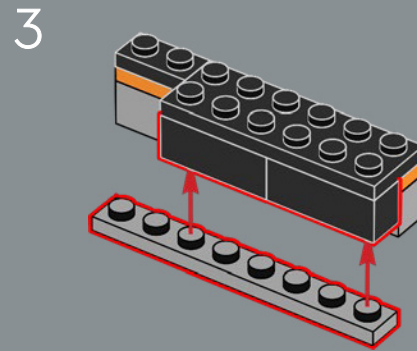
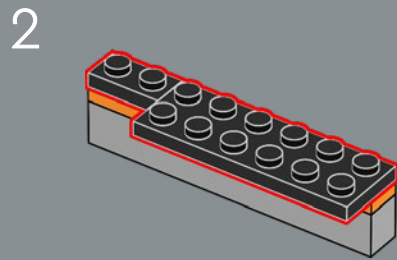
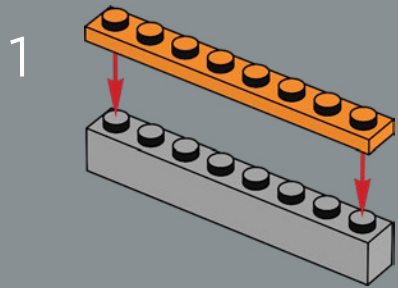

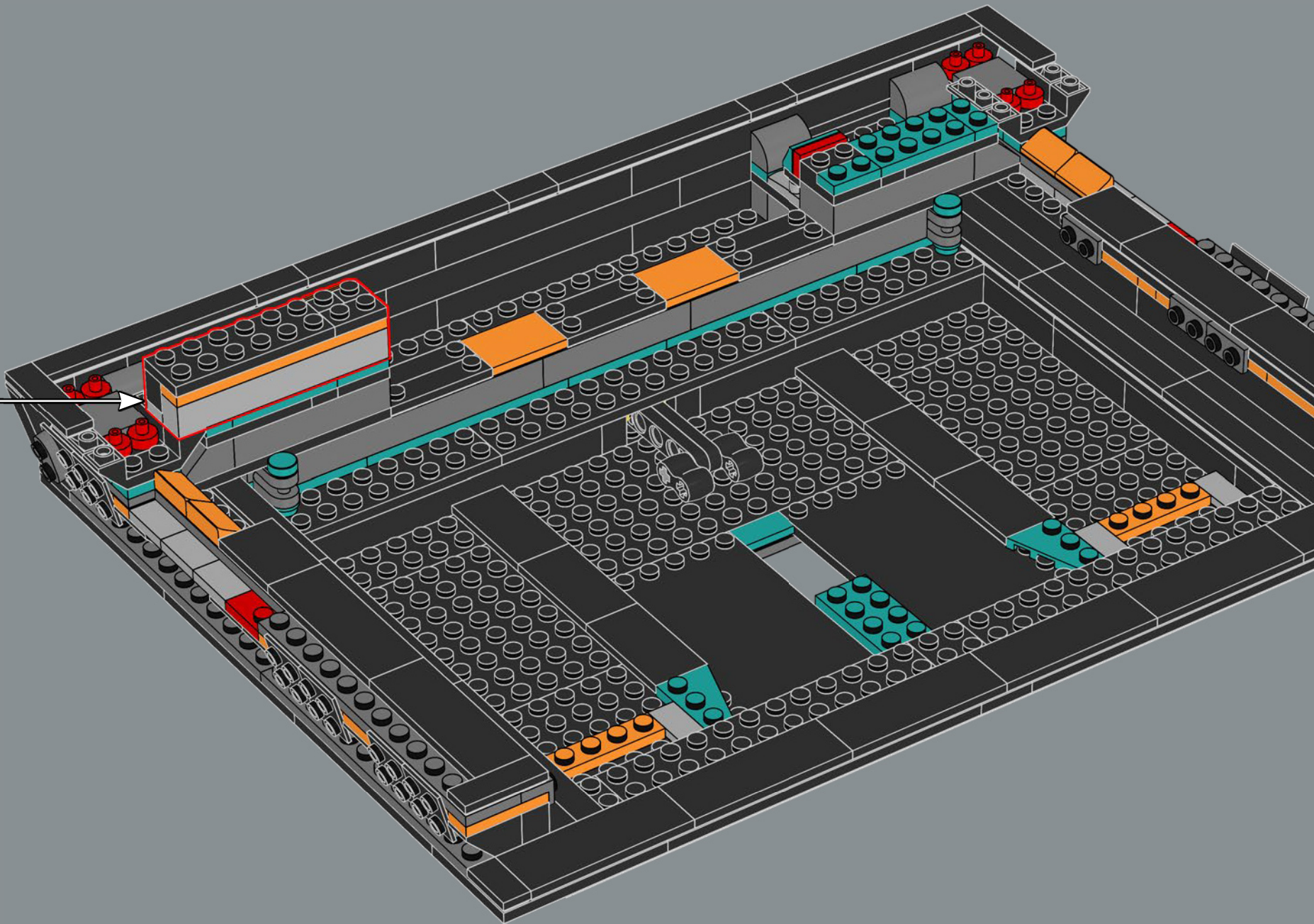

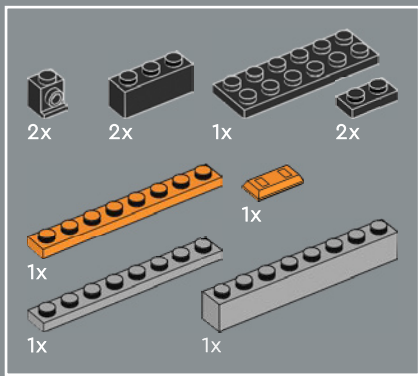

64

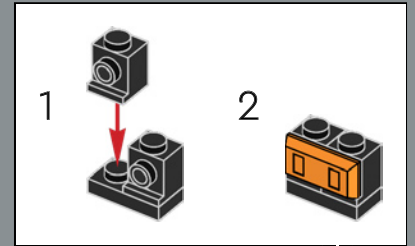
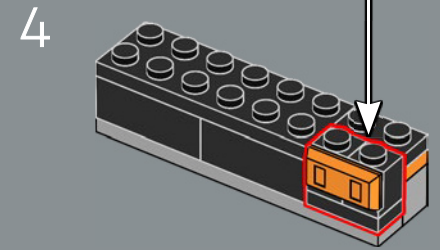
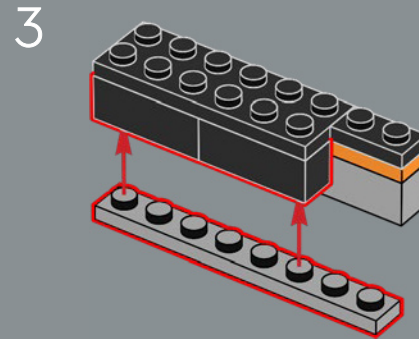
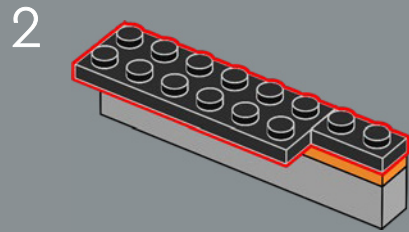
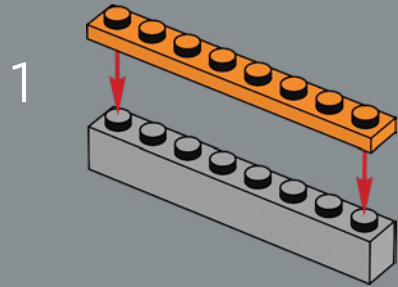

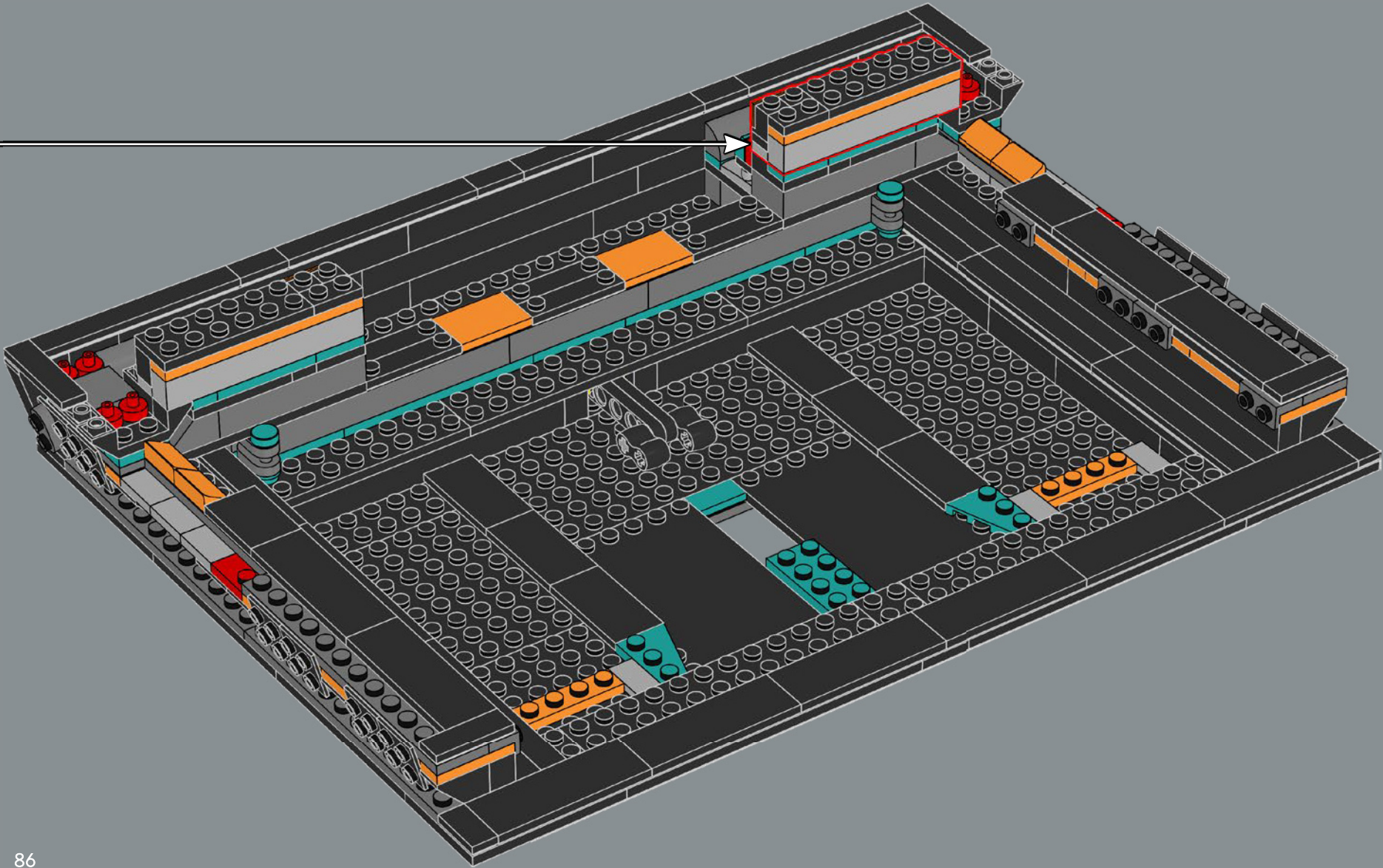

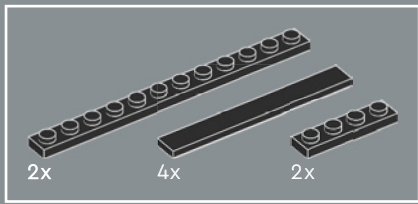

65

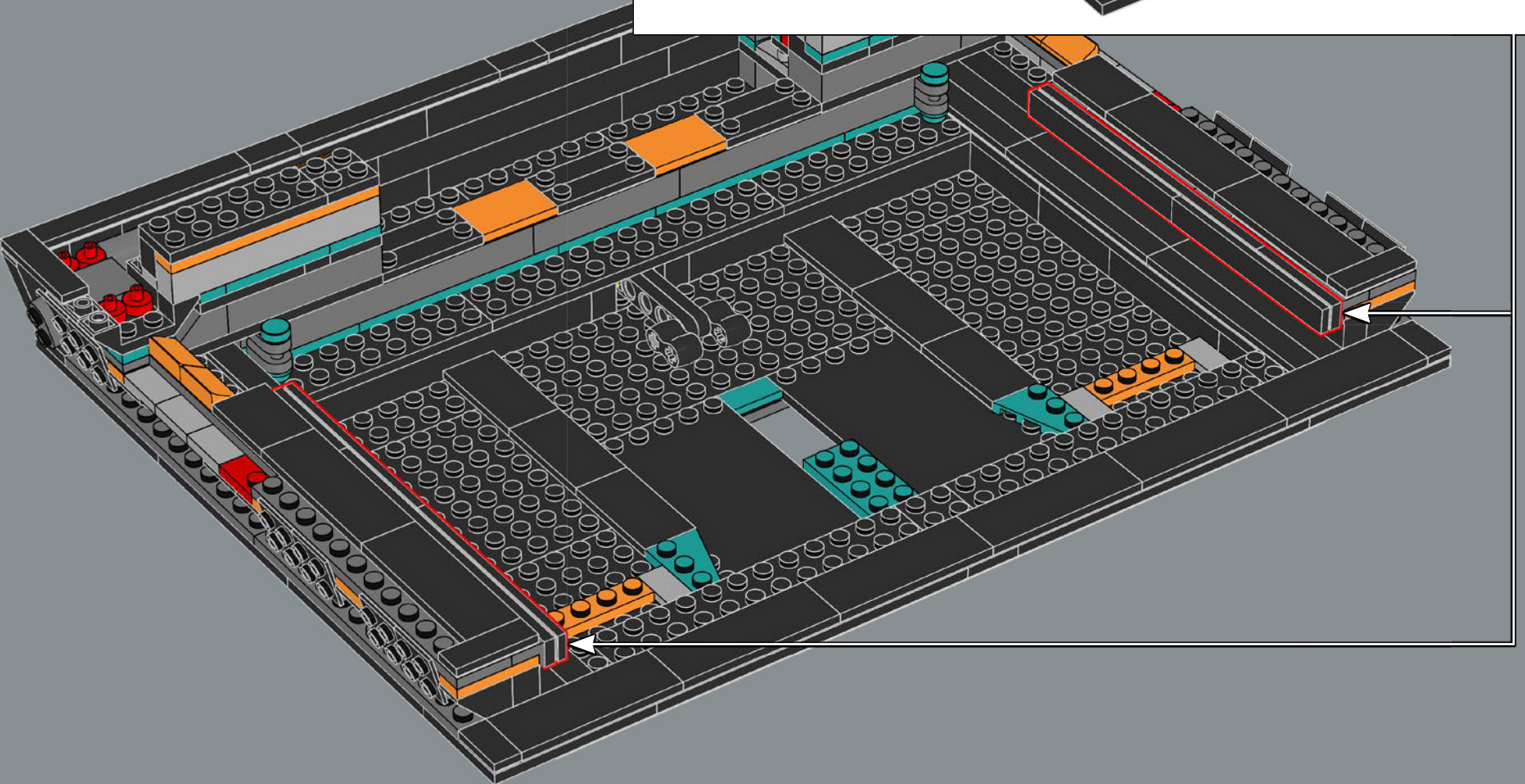
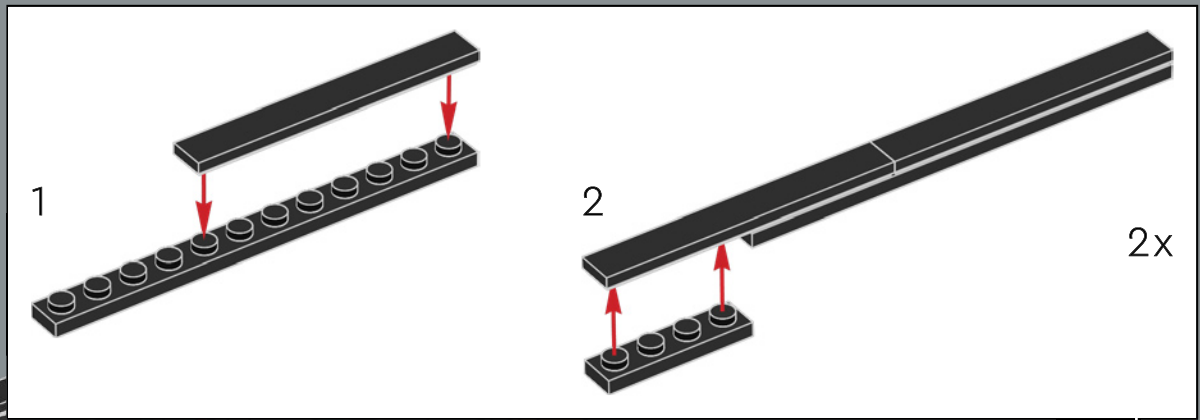

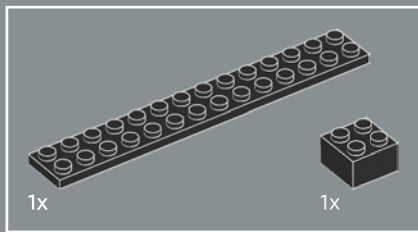

66

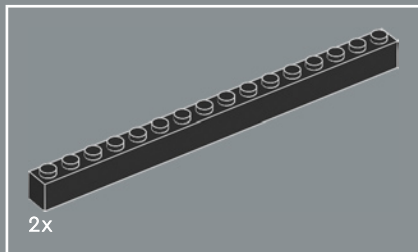
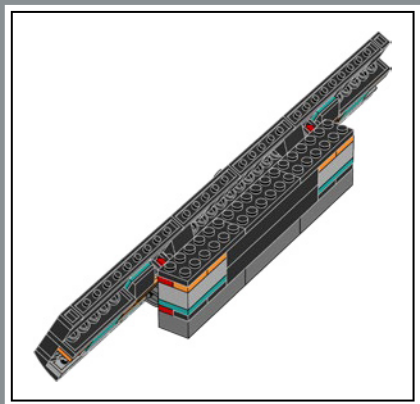
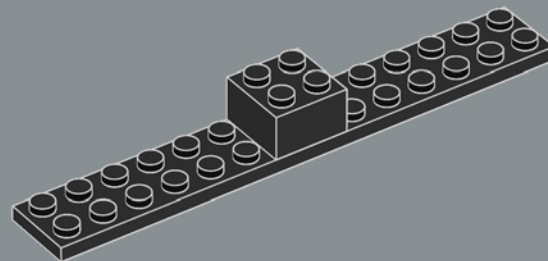

67

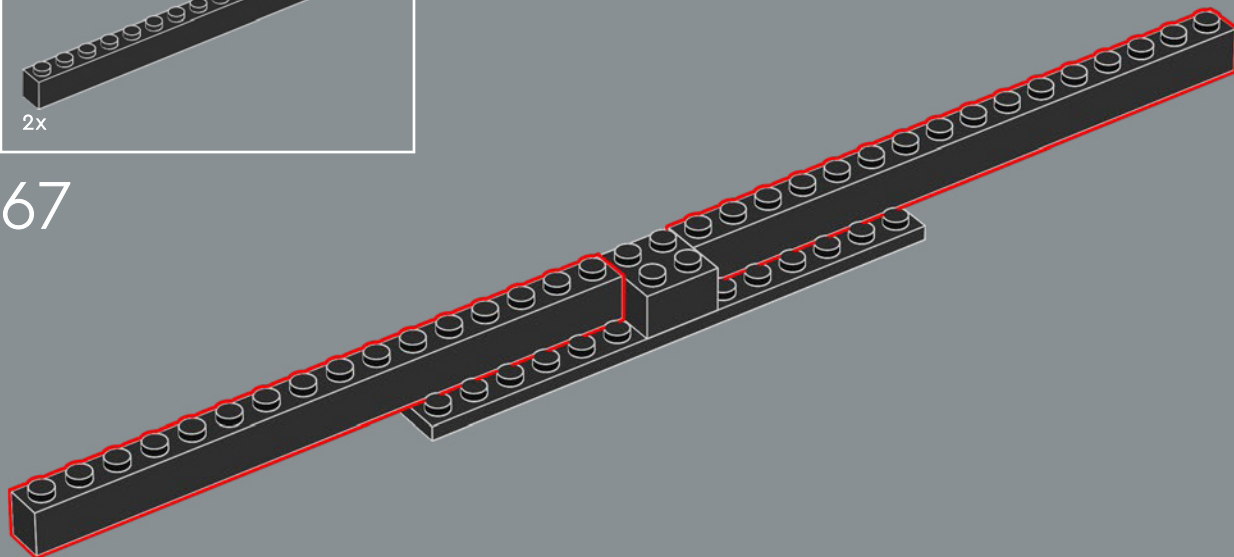

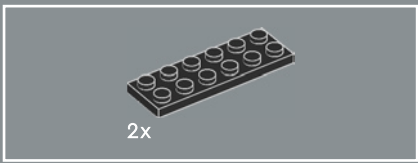

68

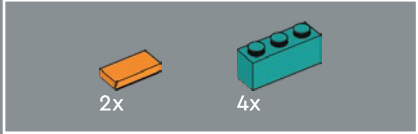
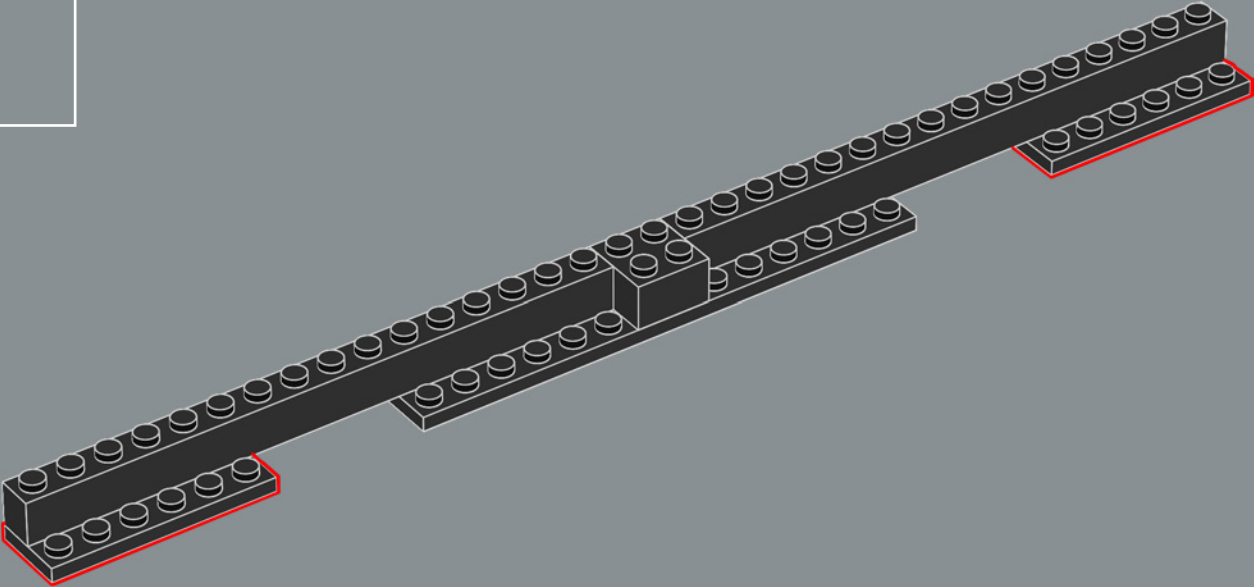

69

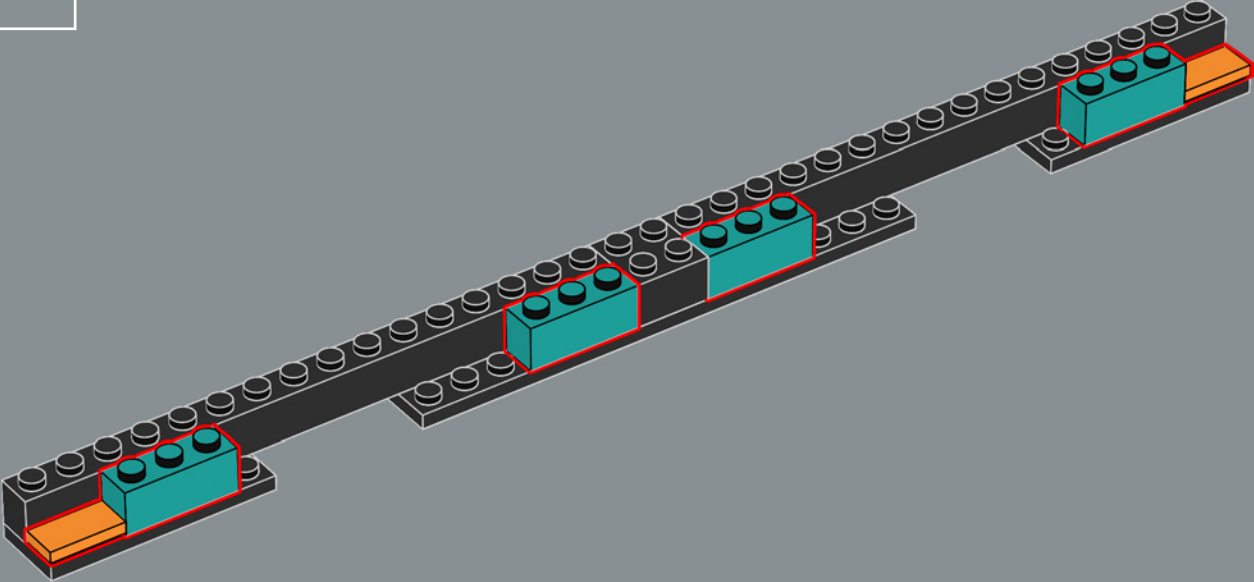

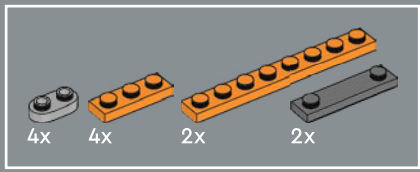

70

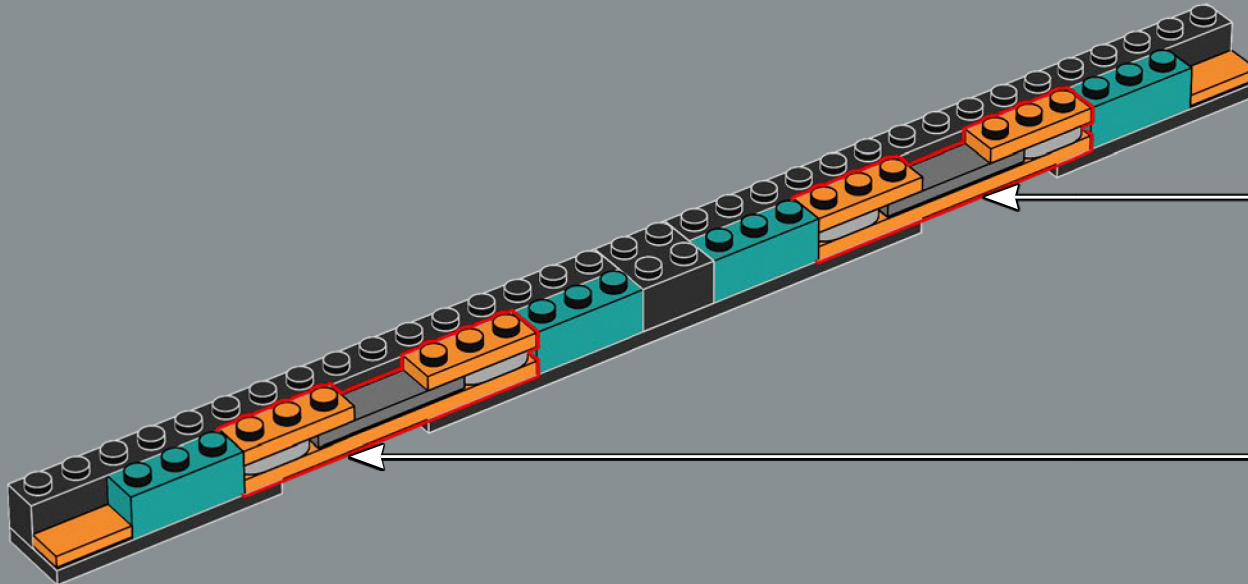
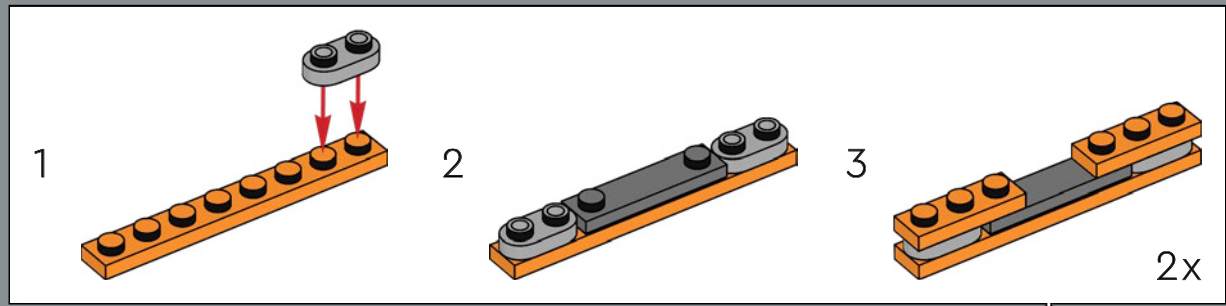

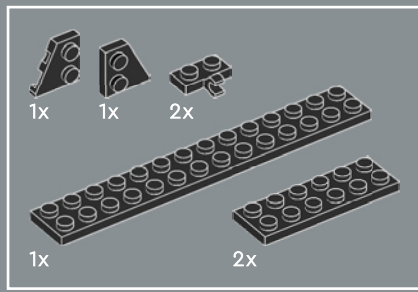

71

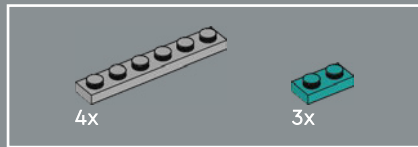
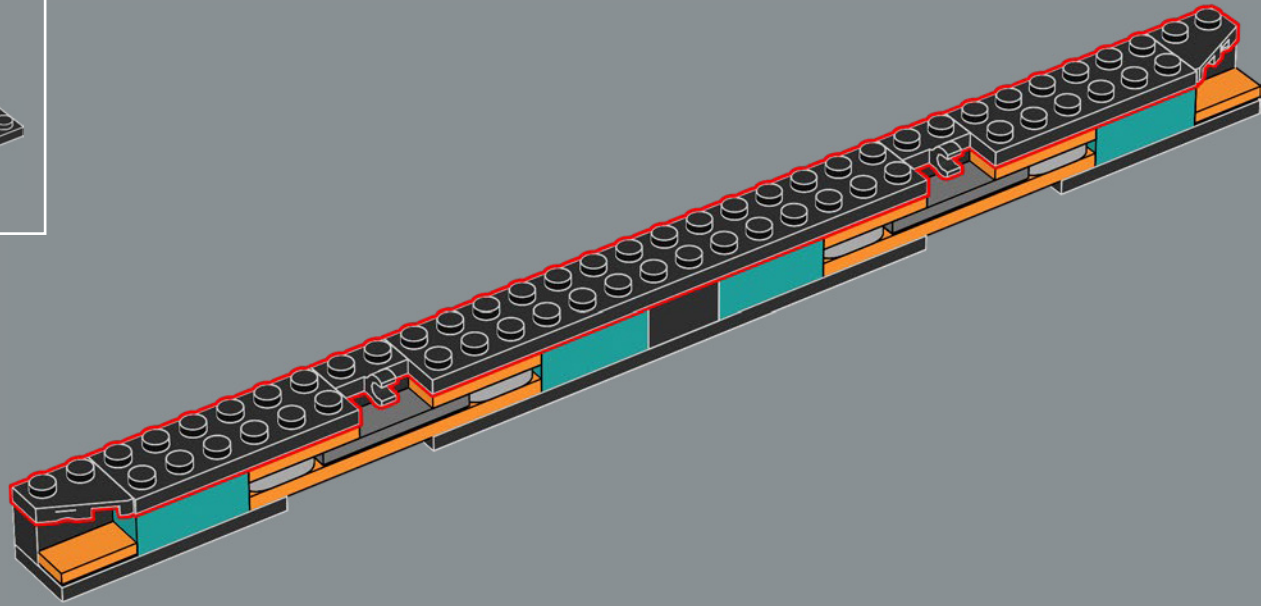

72

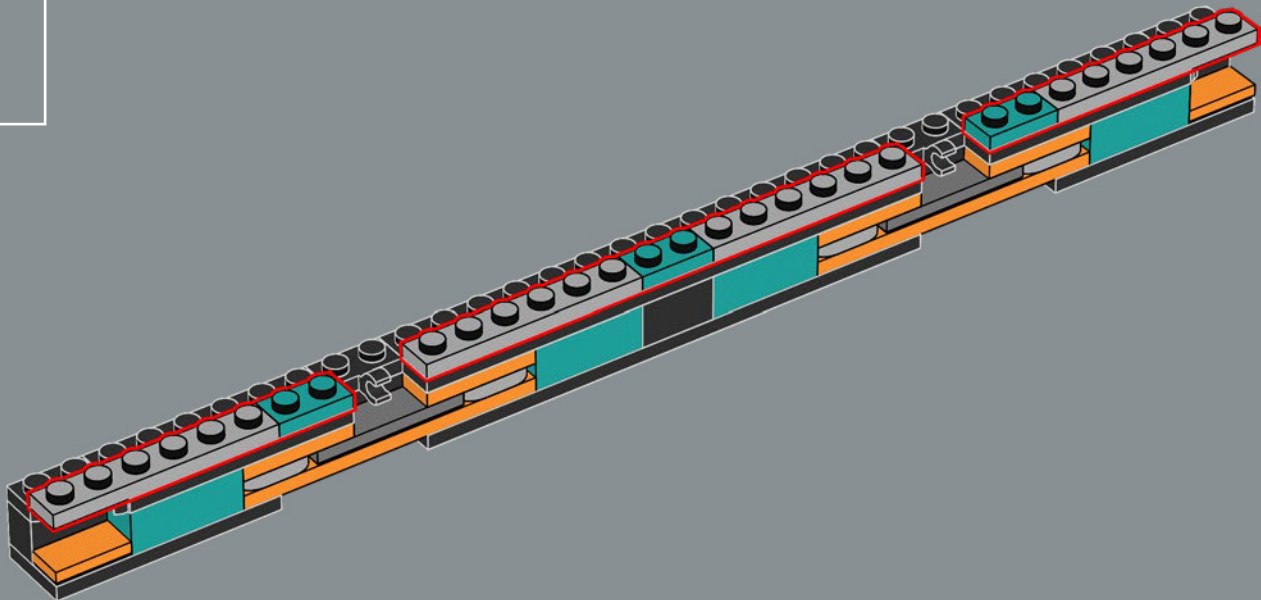

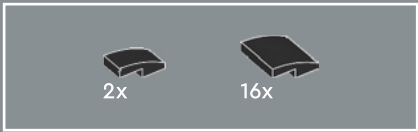

73

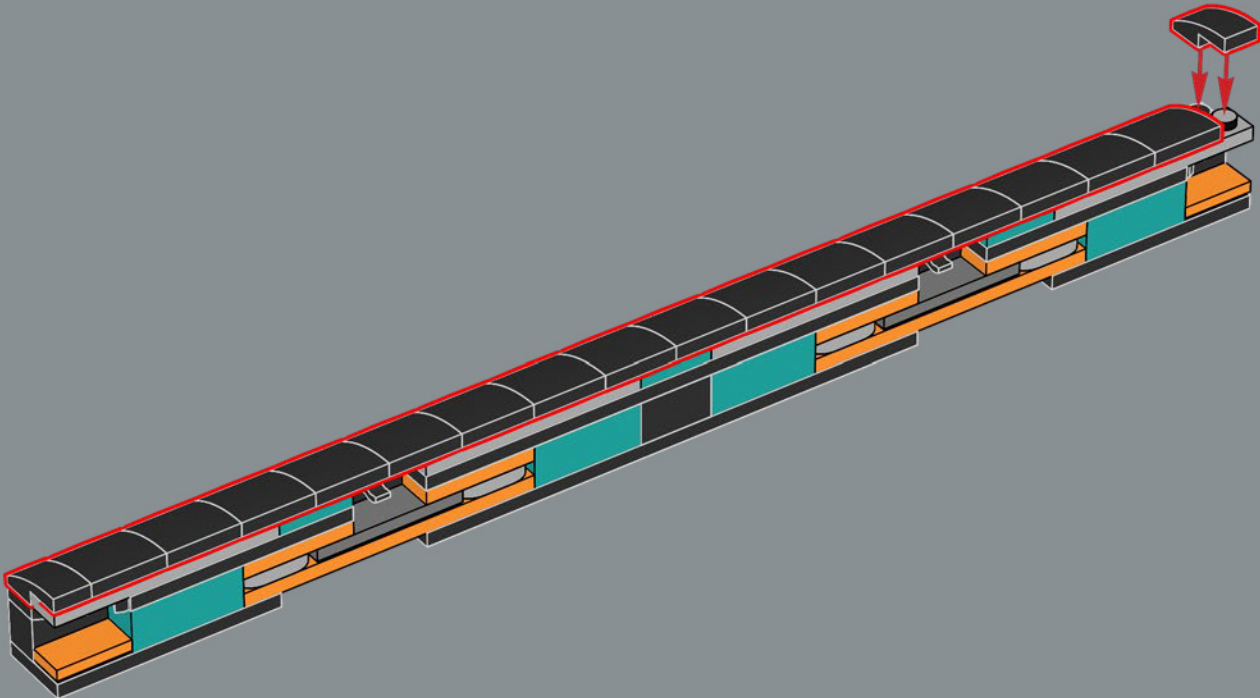

74

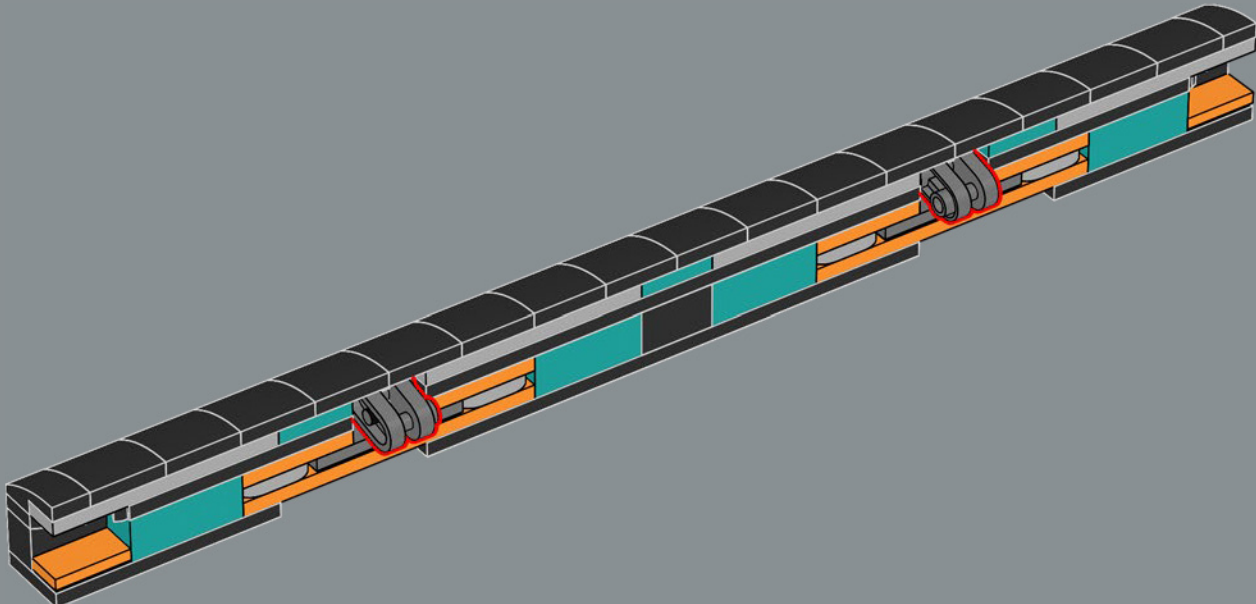

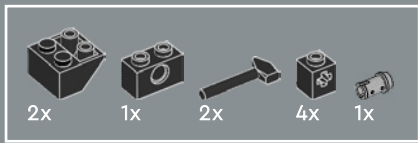

75

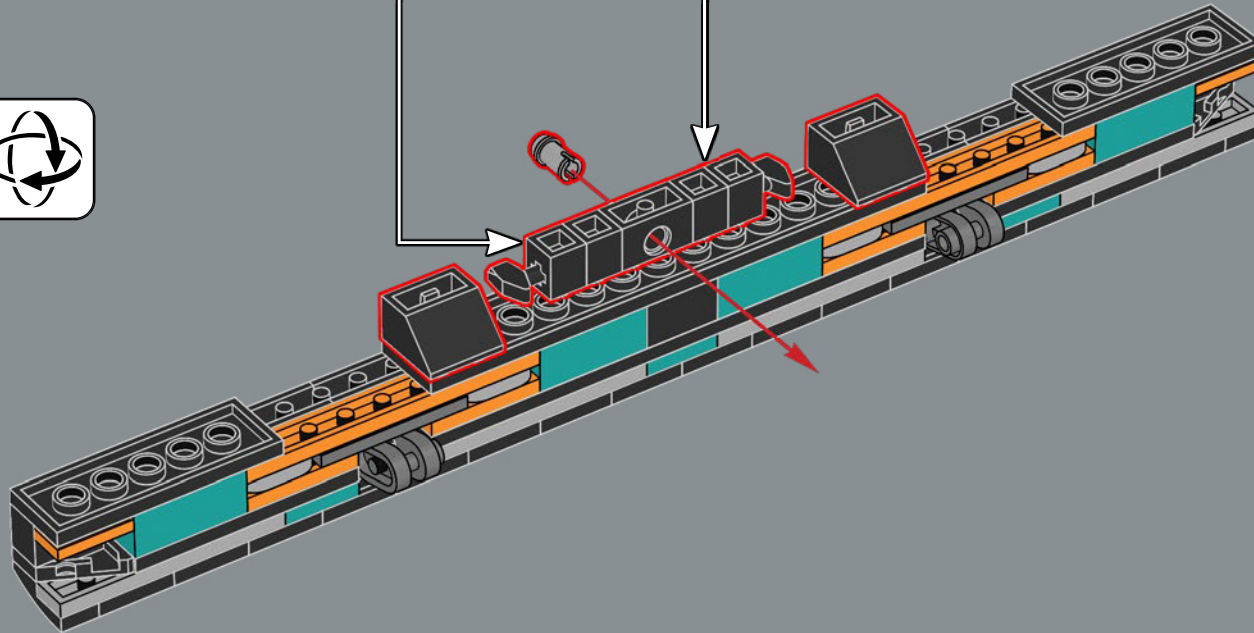
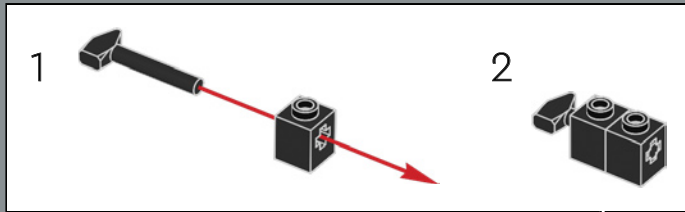
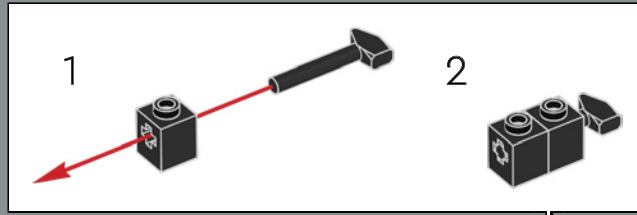

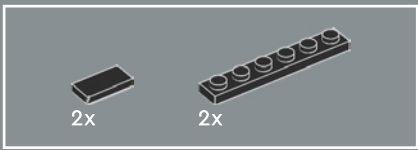

76

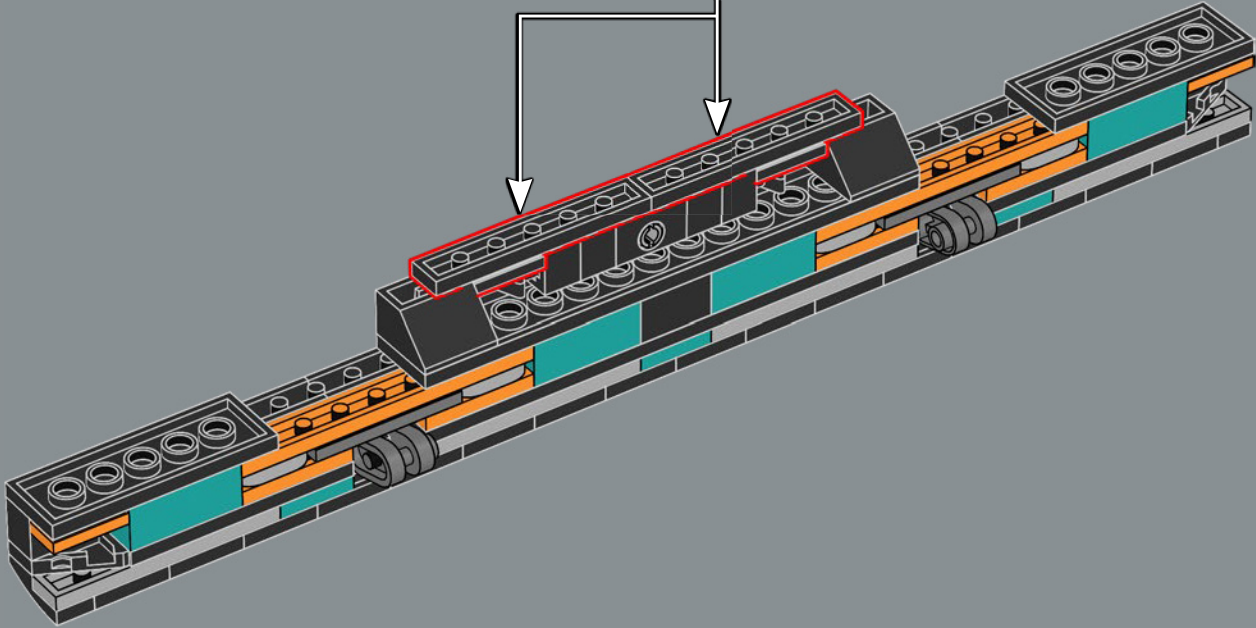
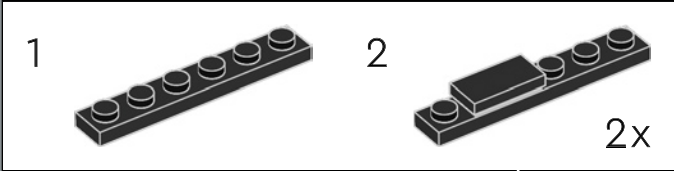

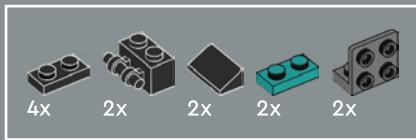

77

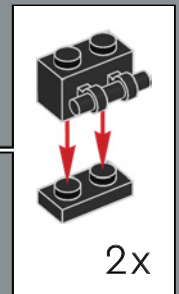
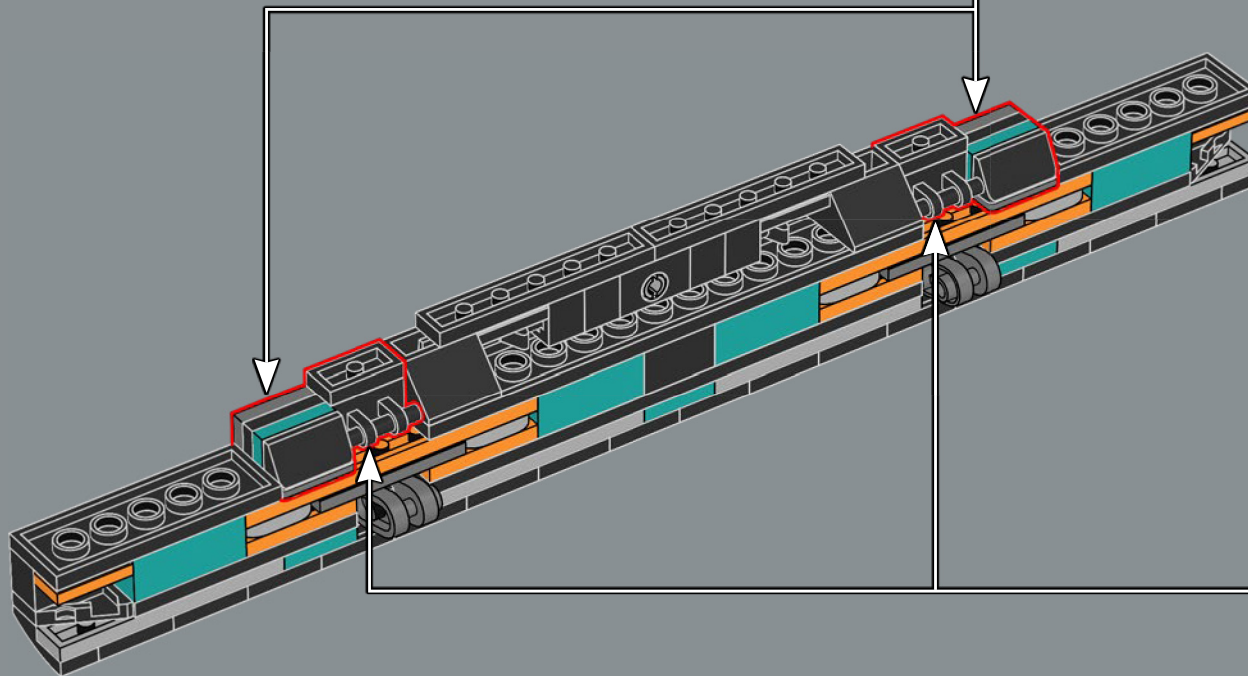
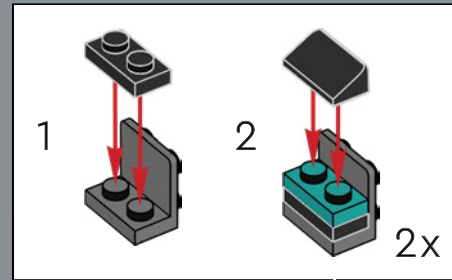

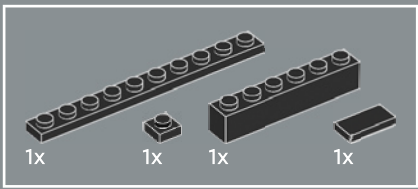

78

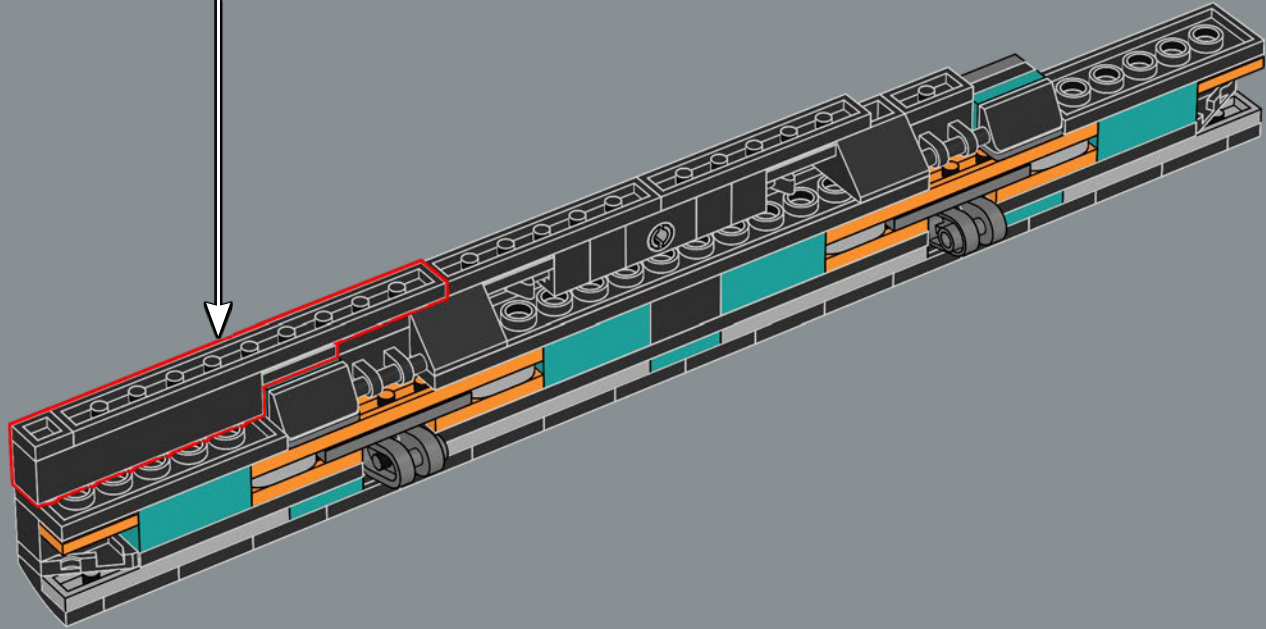
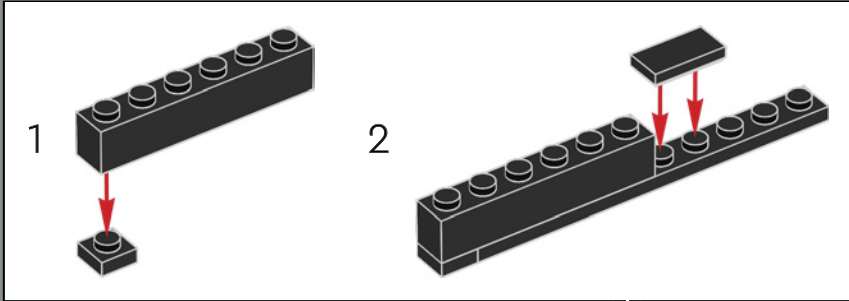

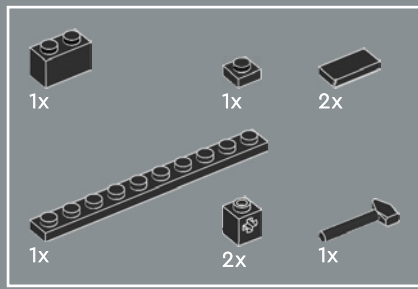

79

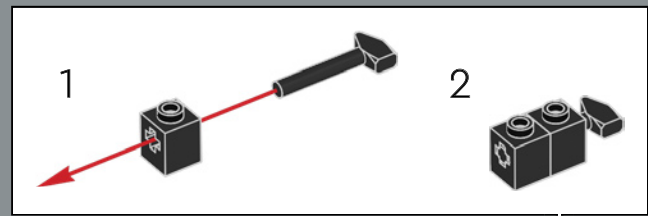
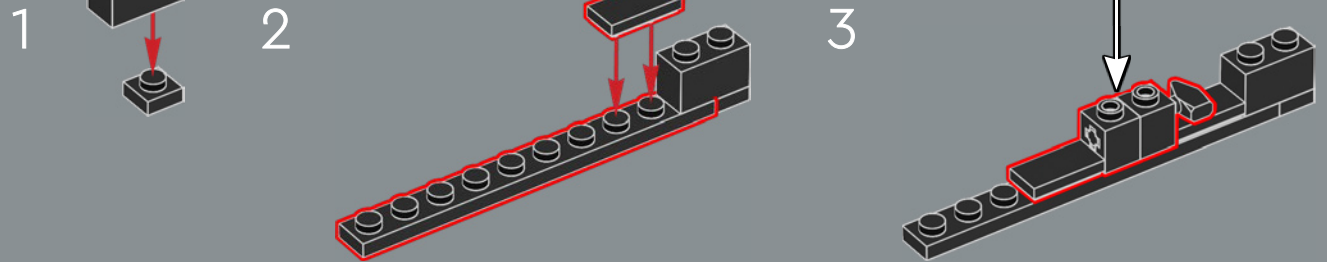

1980年推出的VCS CX-2600A型主机
将前置开关数量减少至四个,并将两个
难度开关重新放到主机的背面。

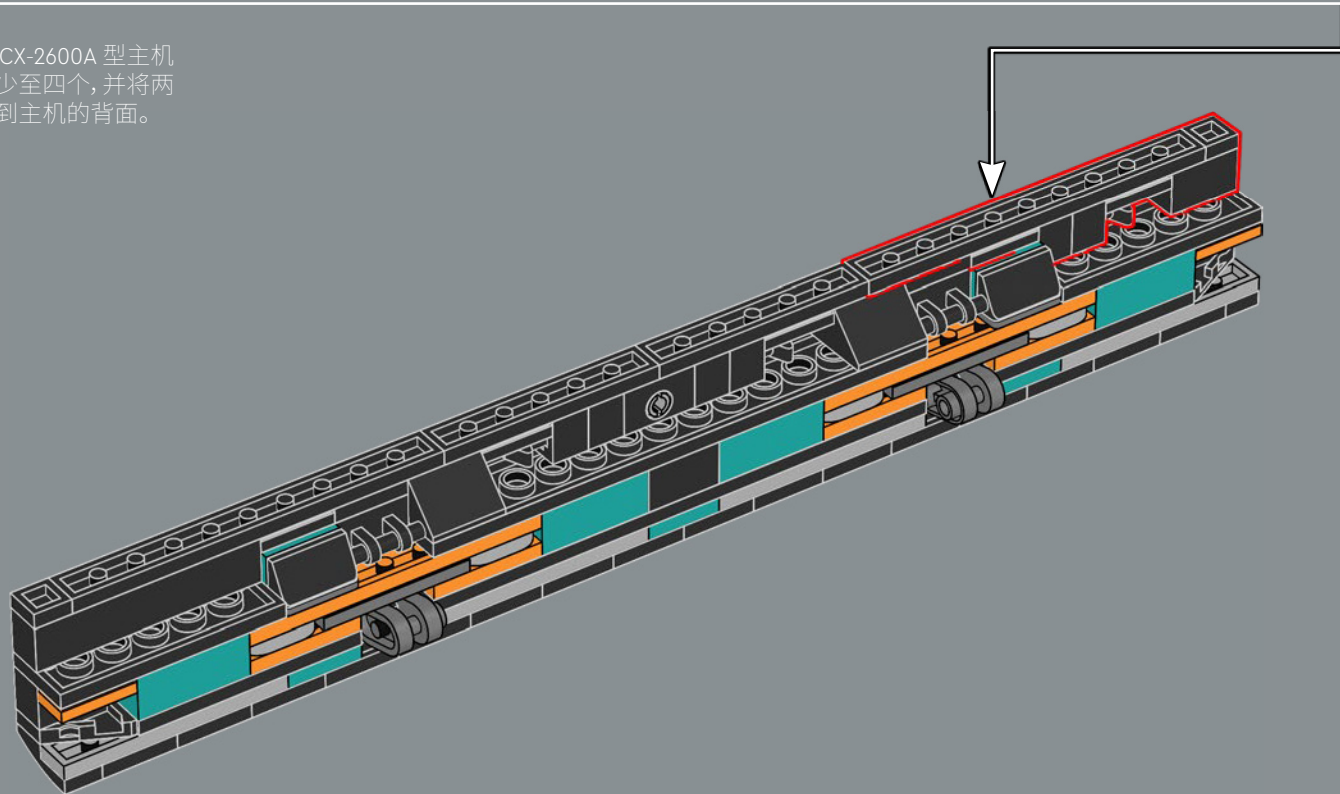

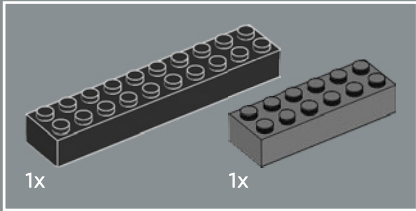
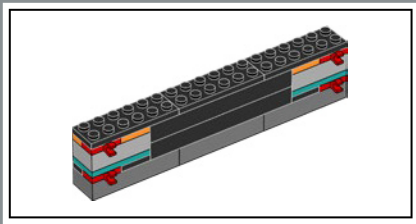

80

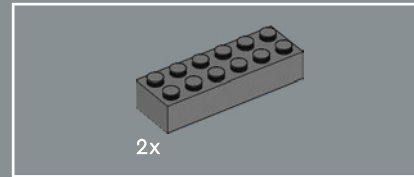
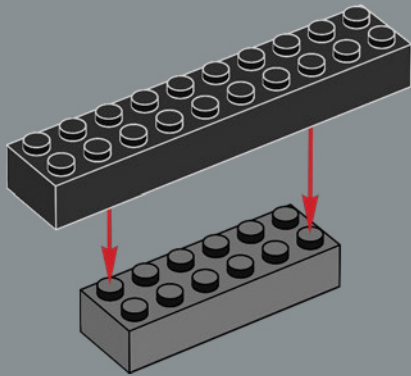

81

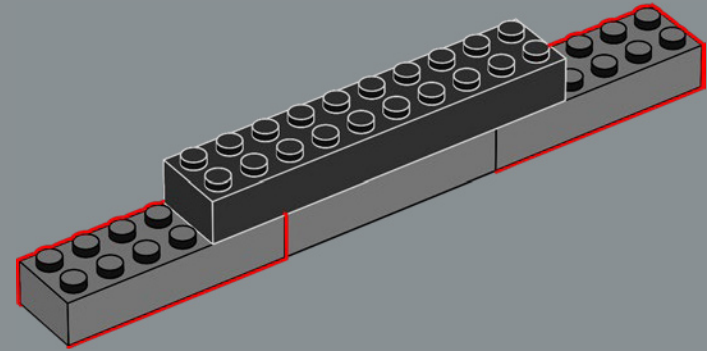

82

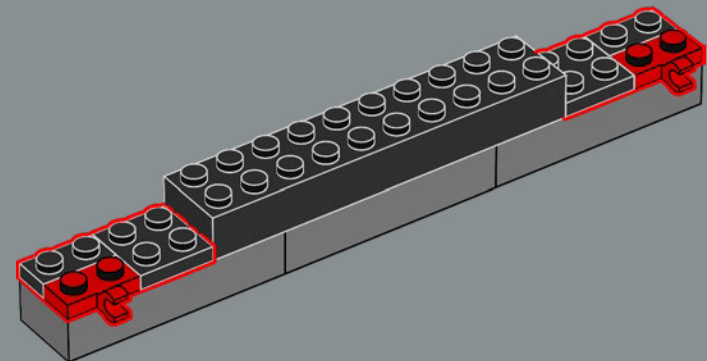

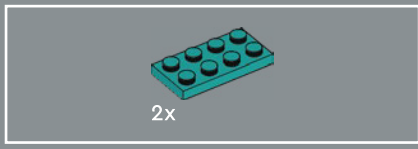

83

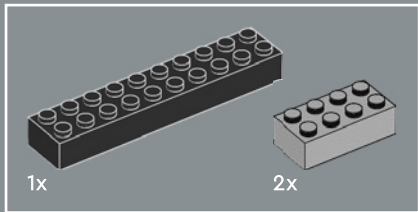
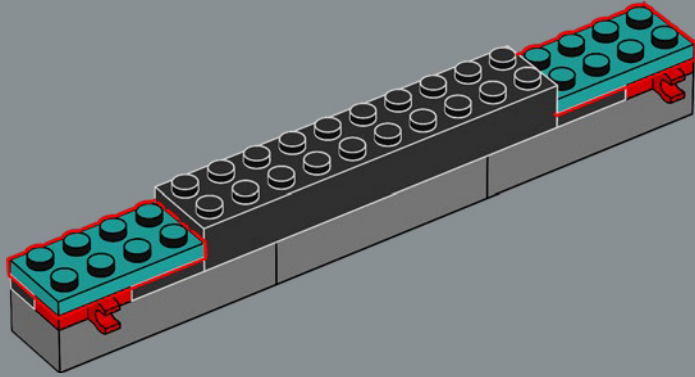

84

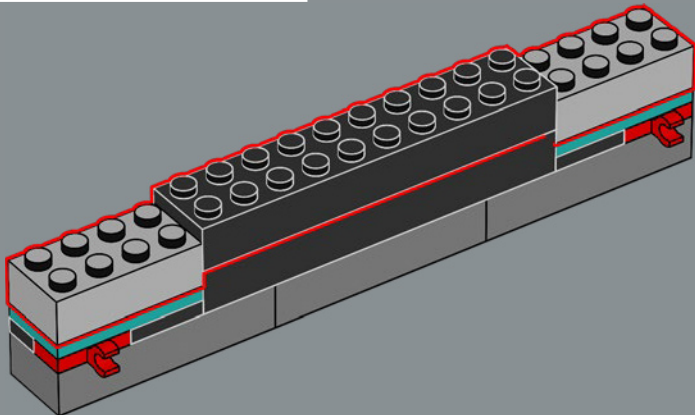

85

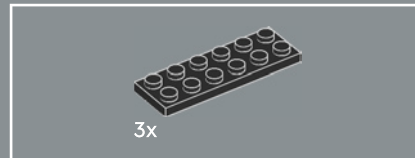
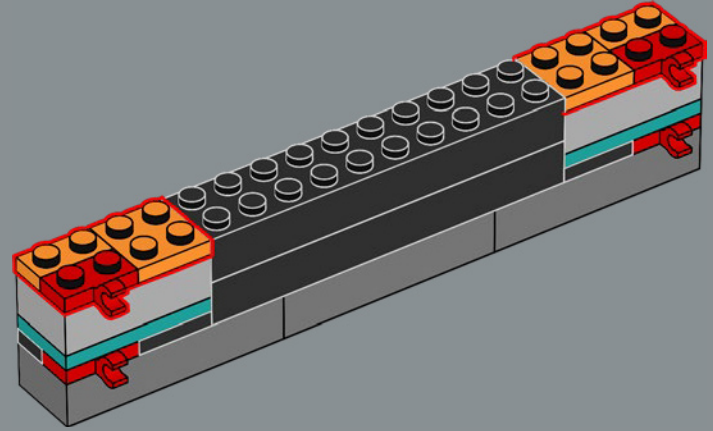

86

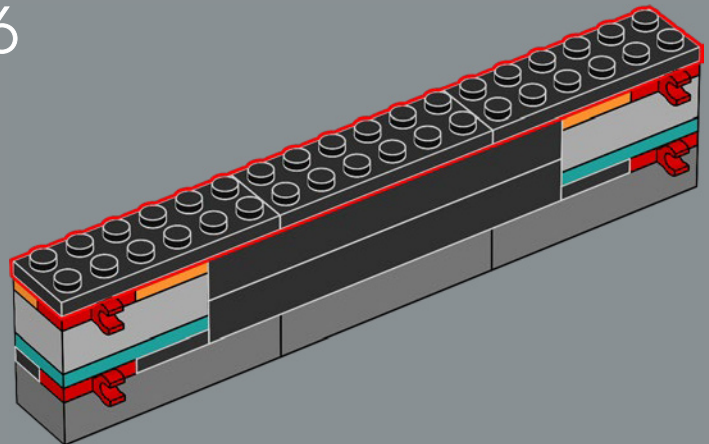

87

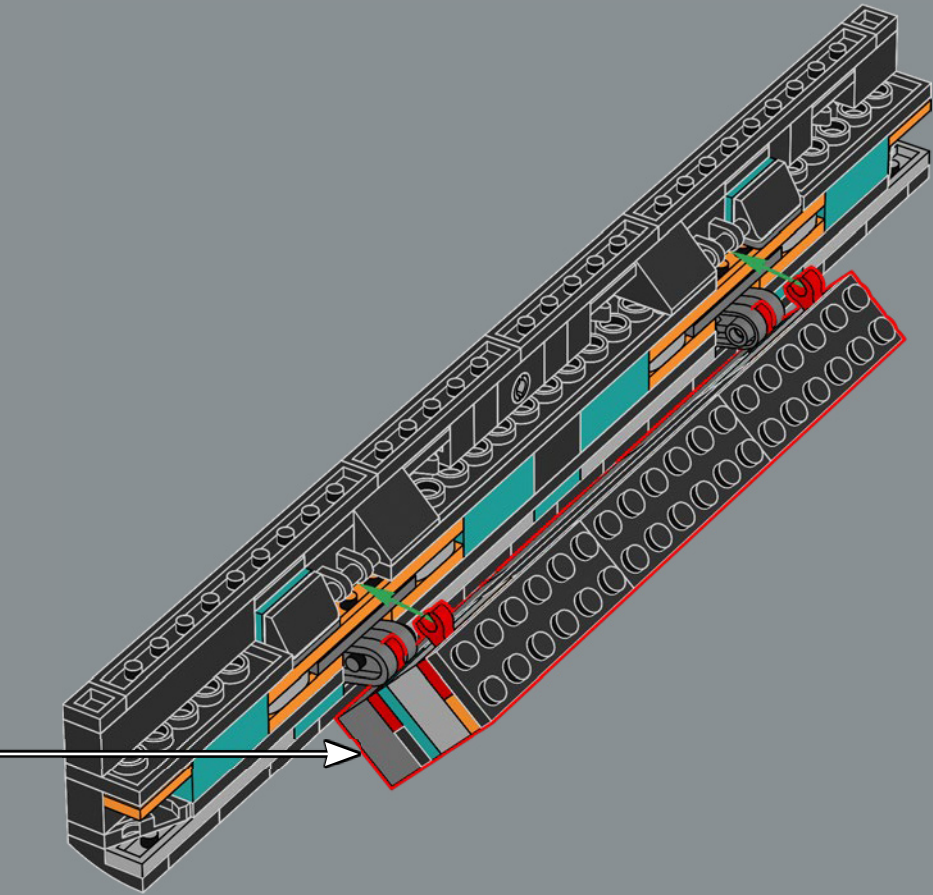

88

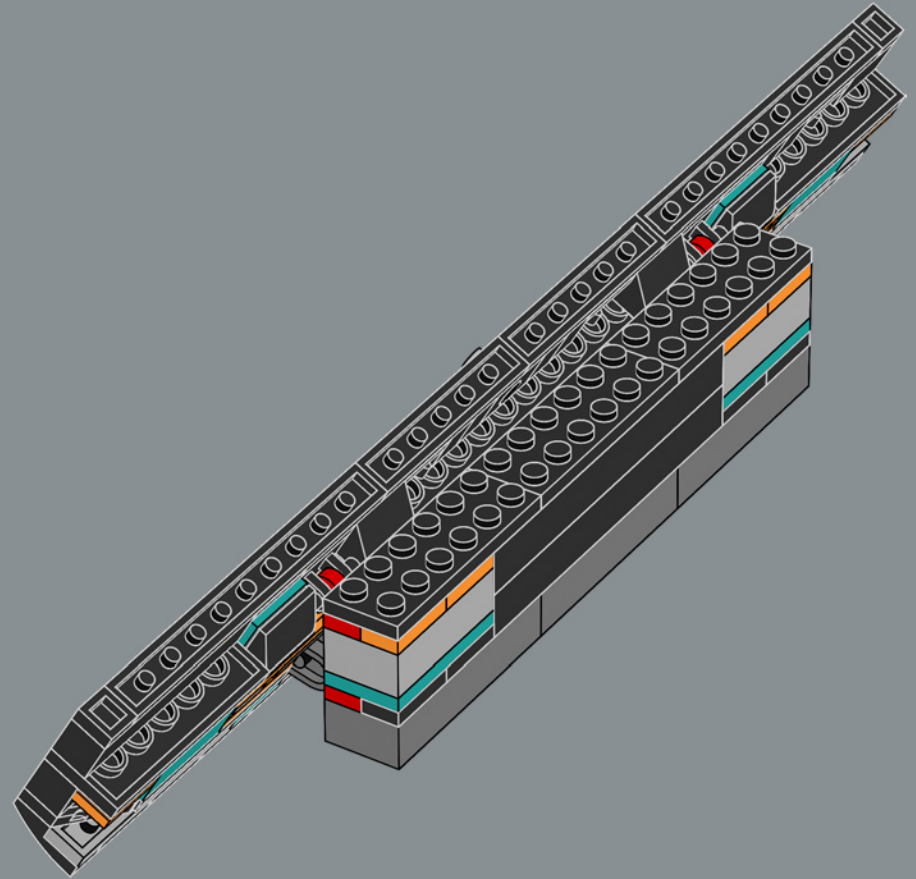

89

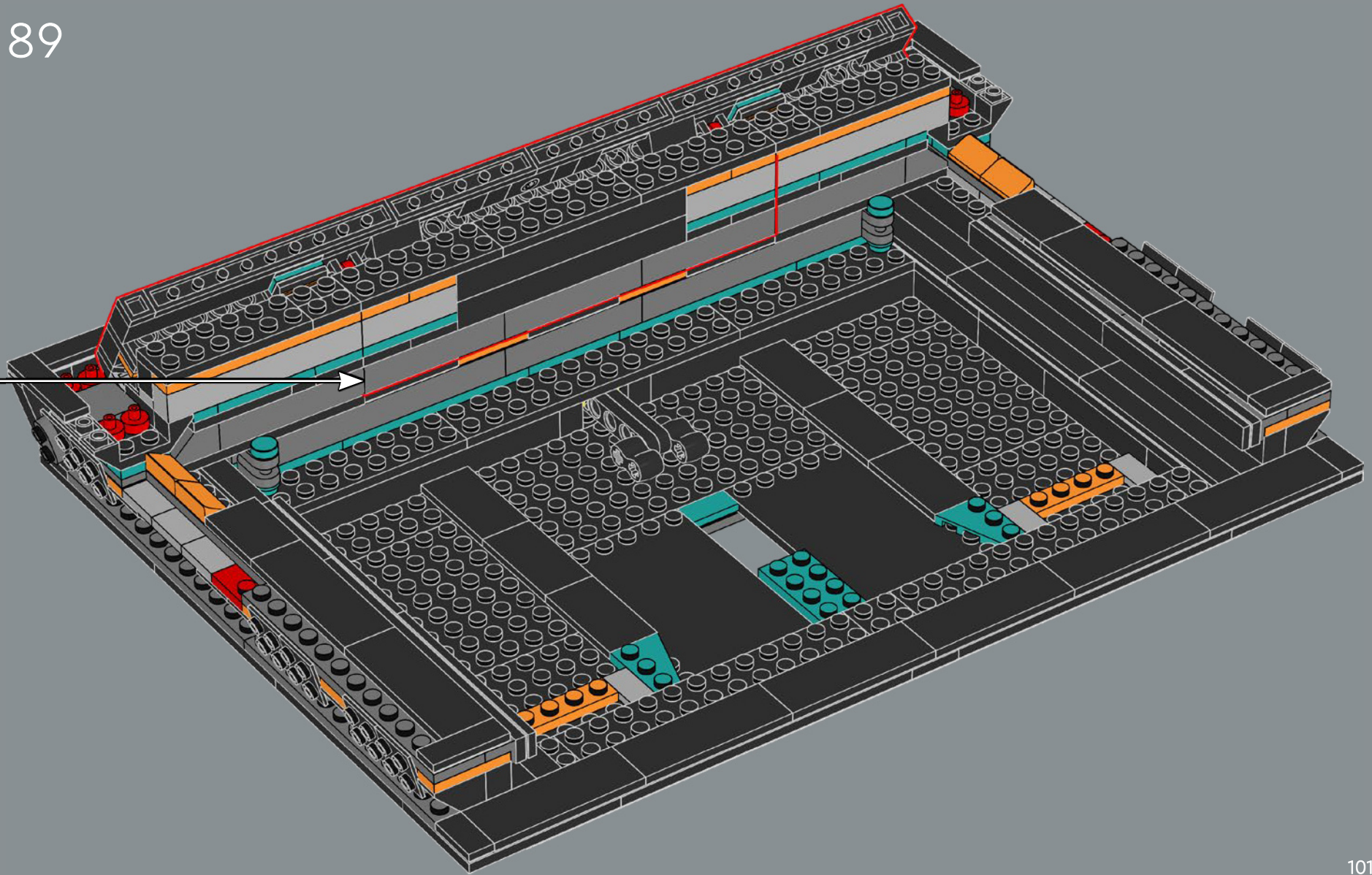



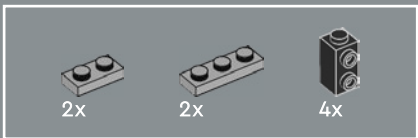

91

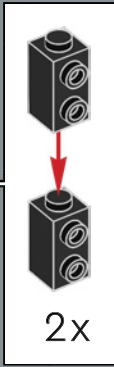
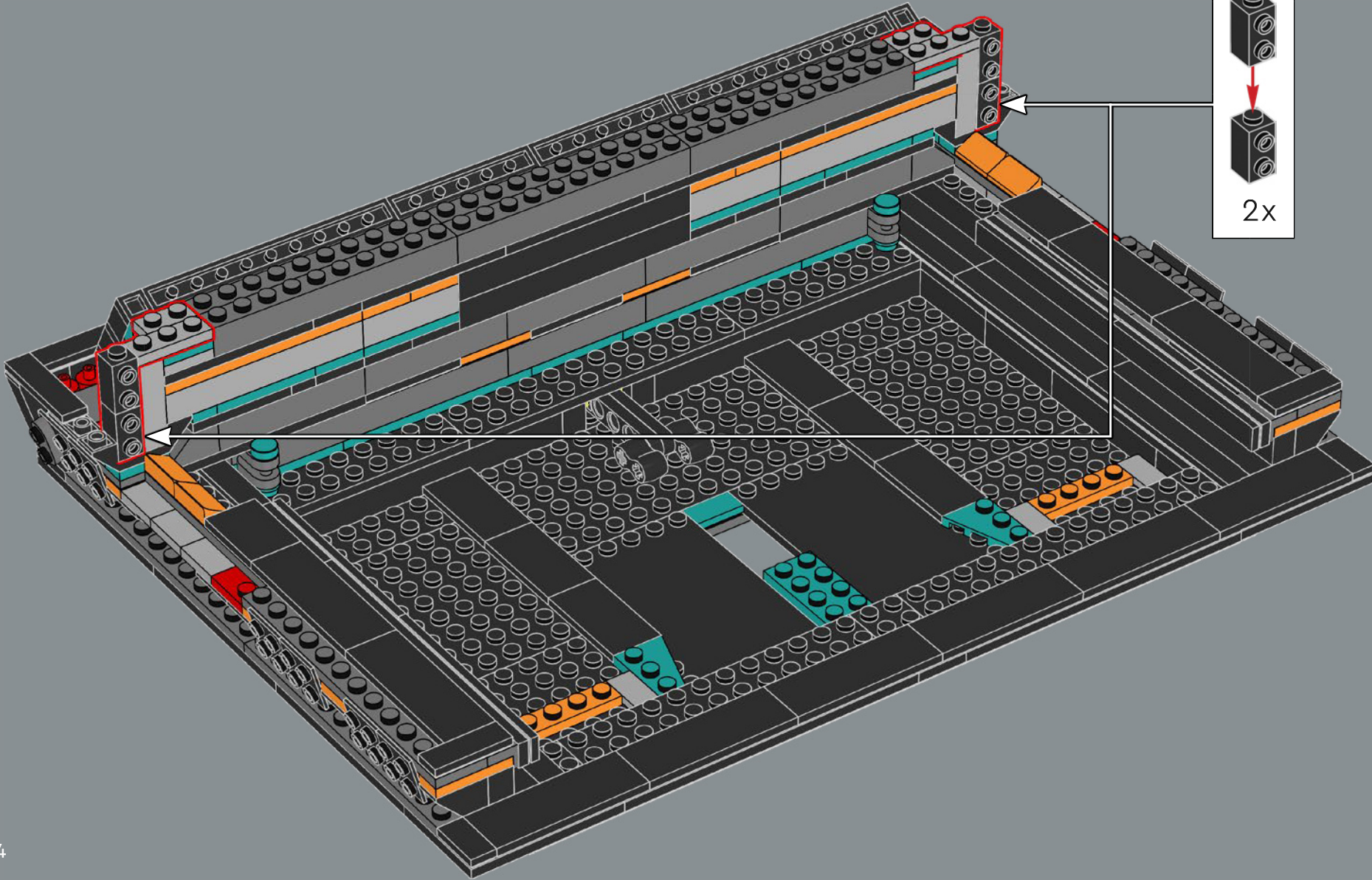

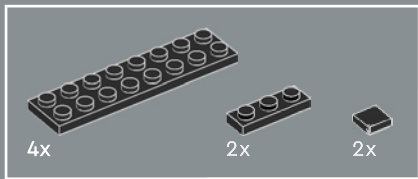

92

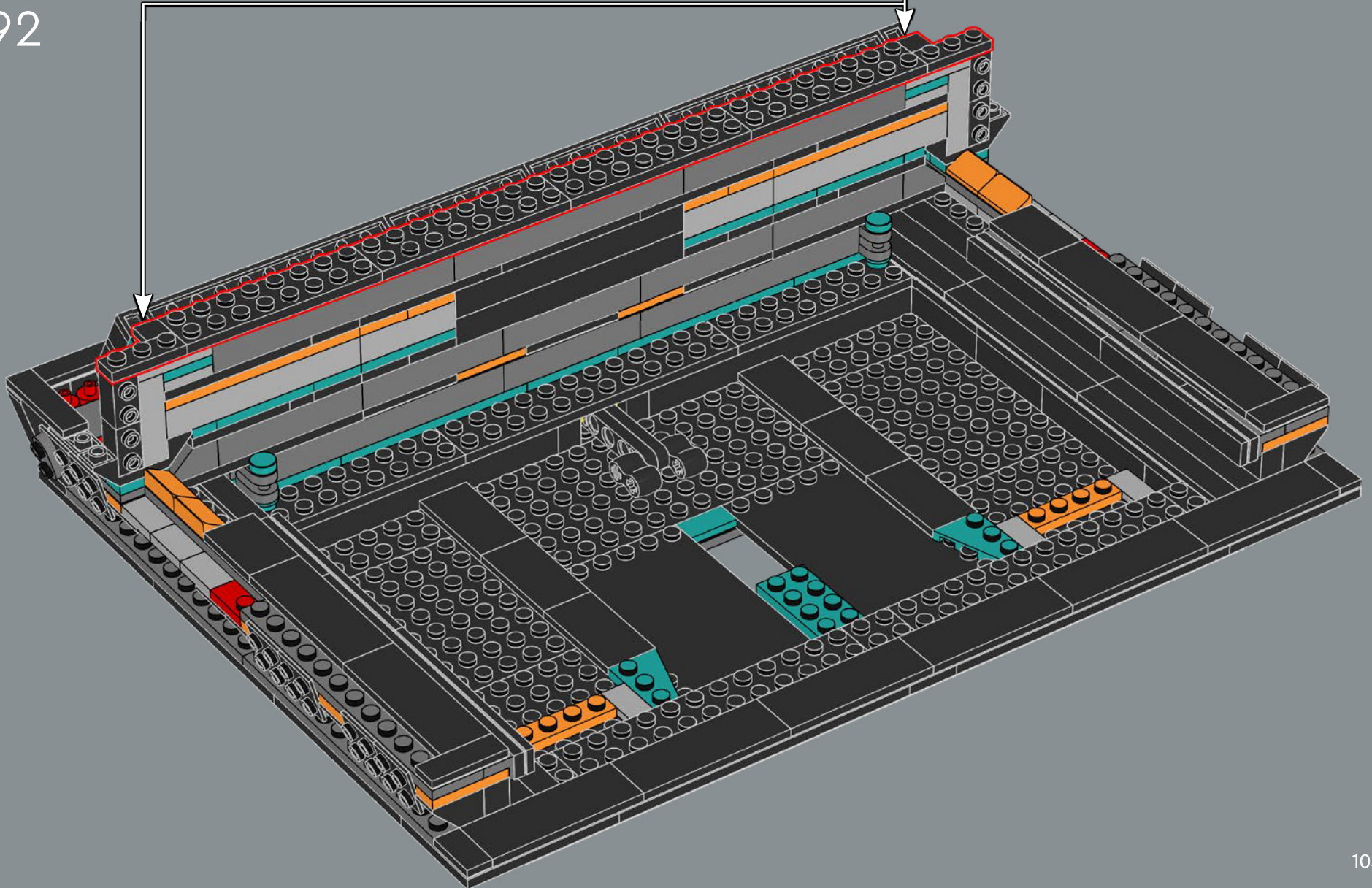

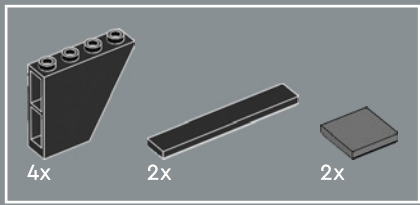

93

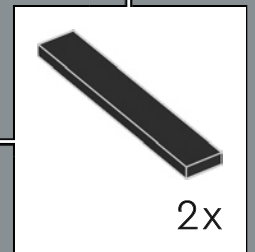
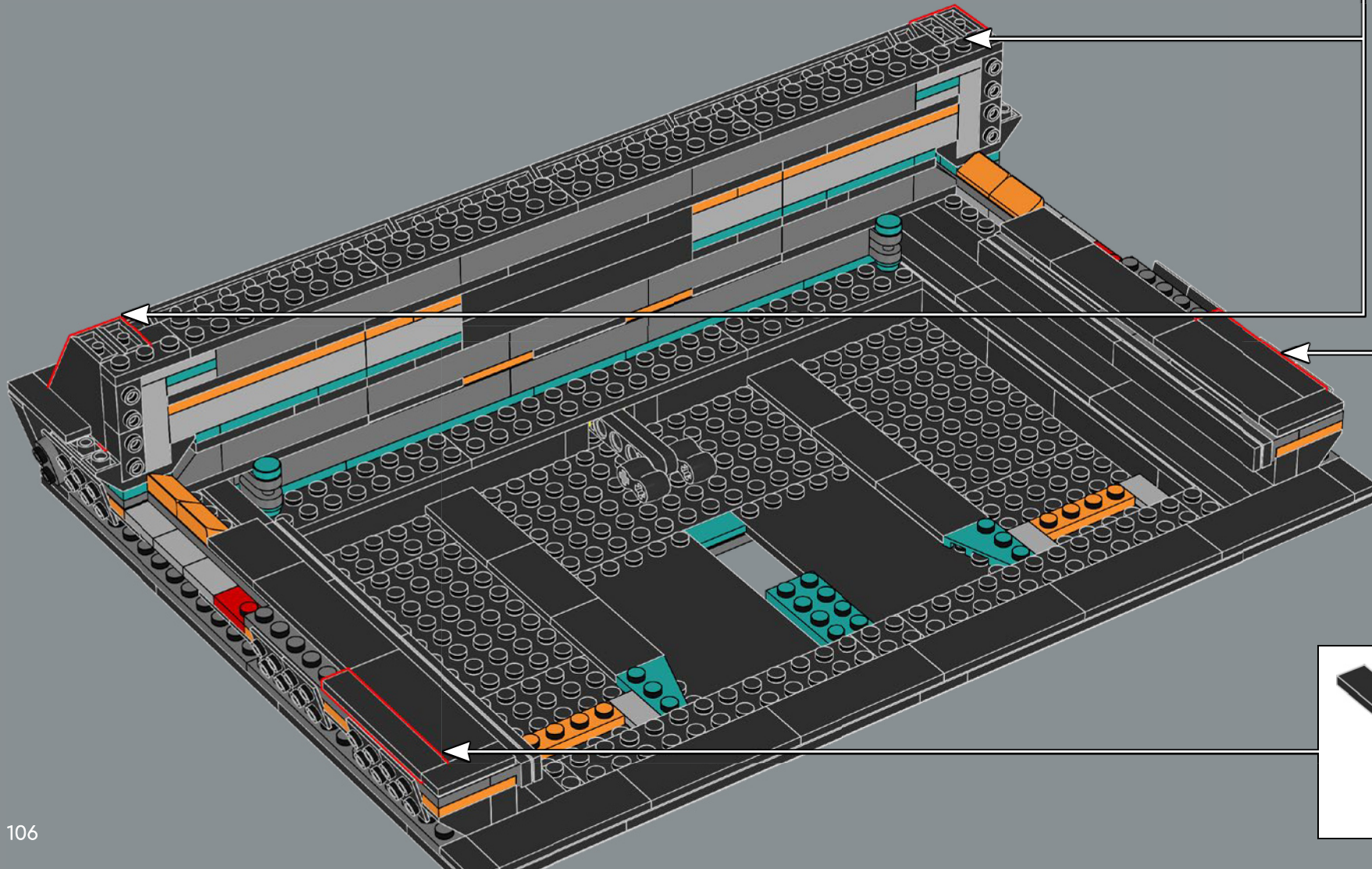
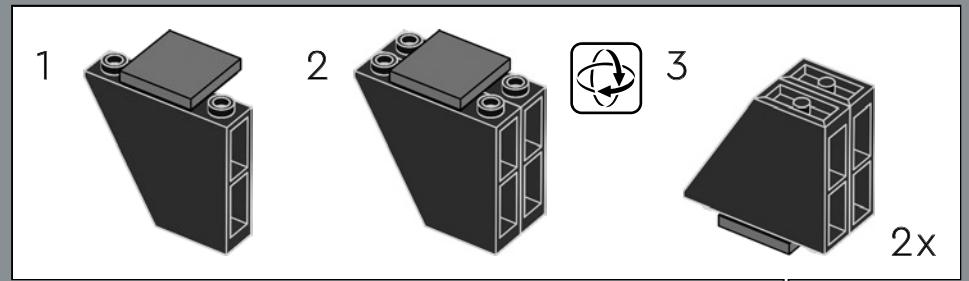

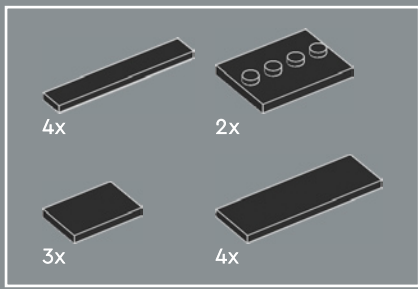

94

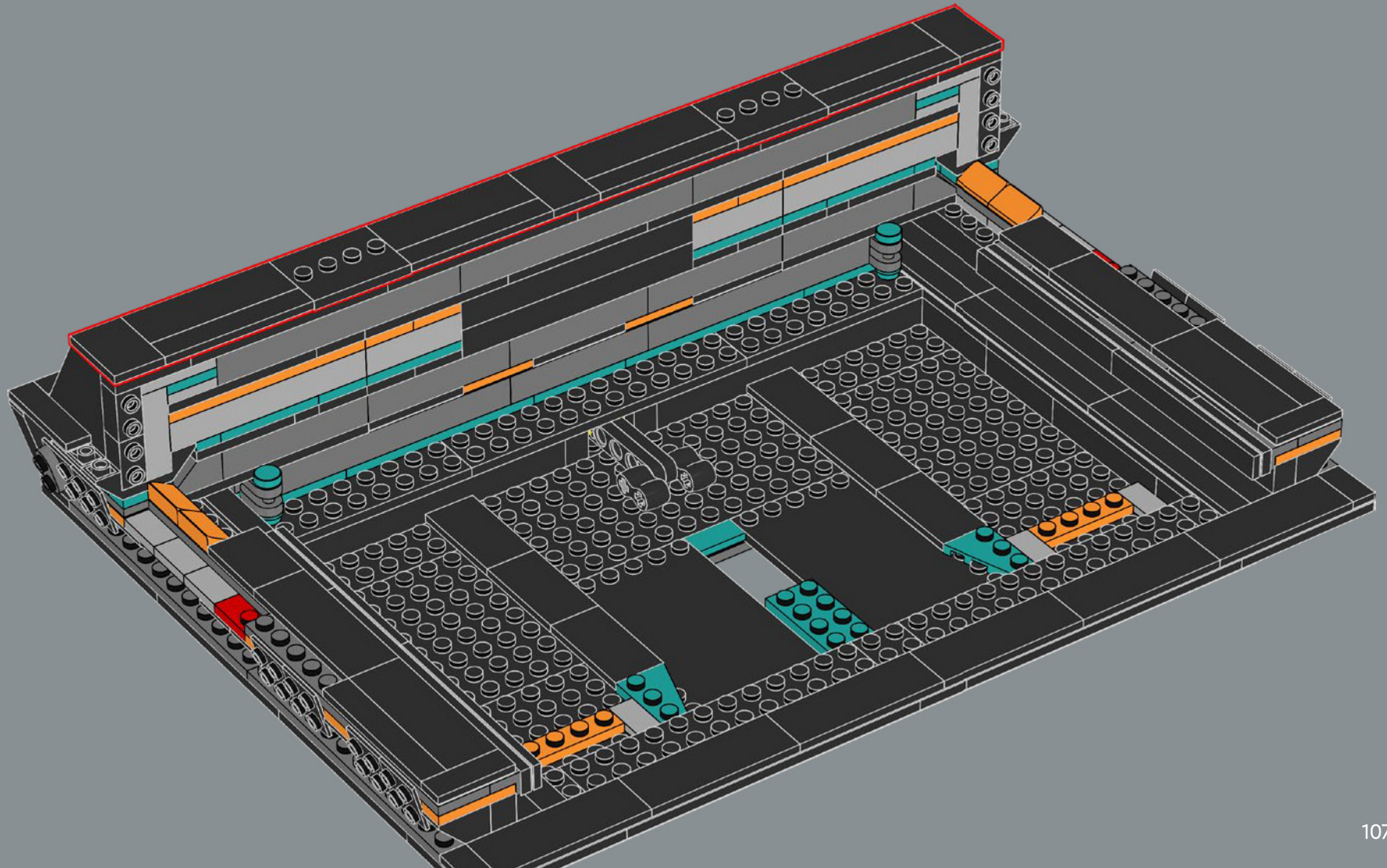

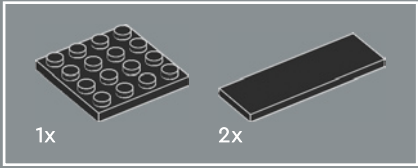
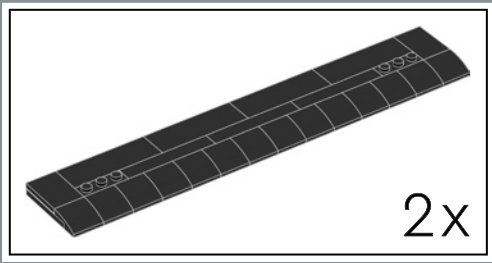

95

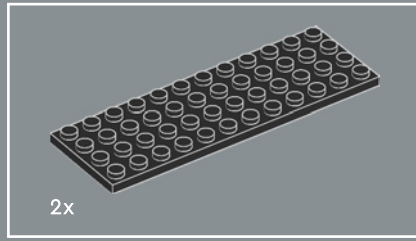
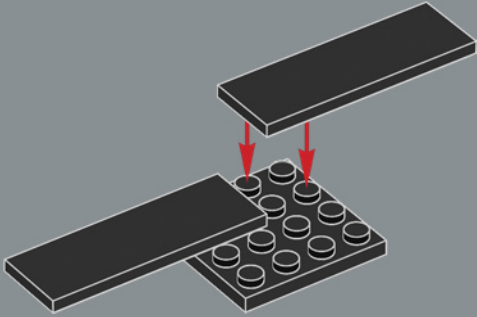

96

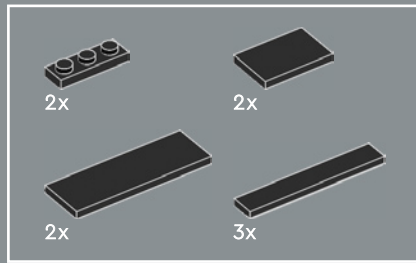
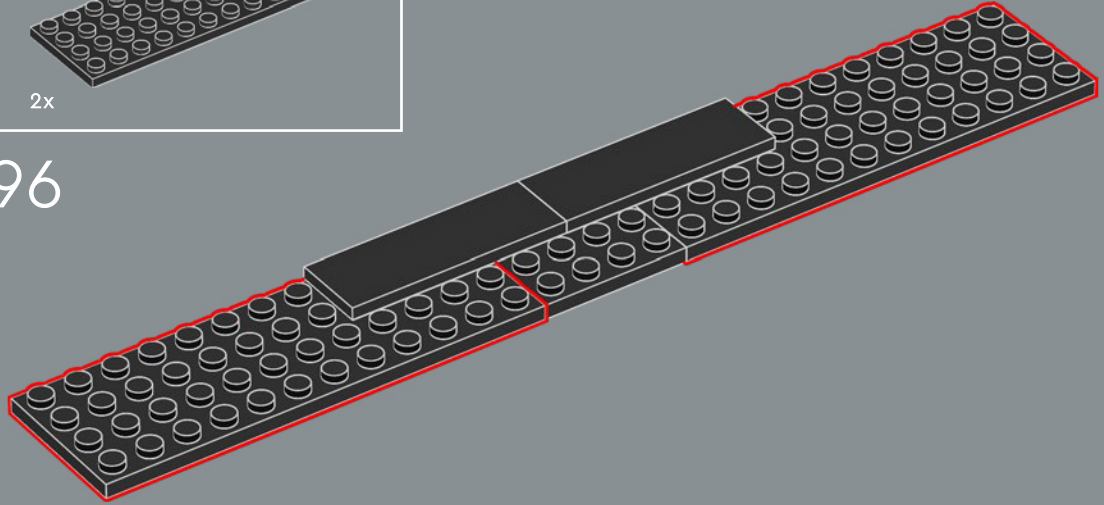

97

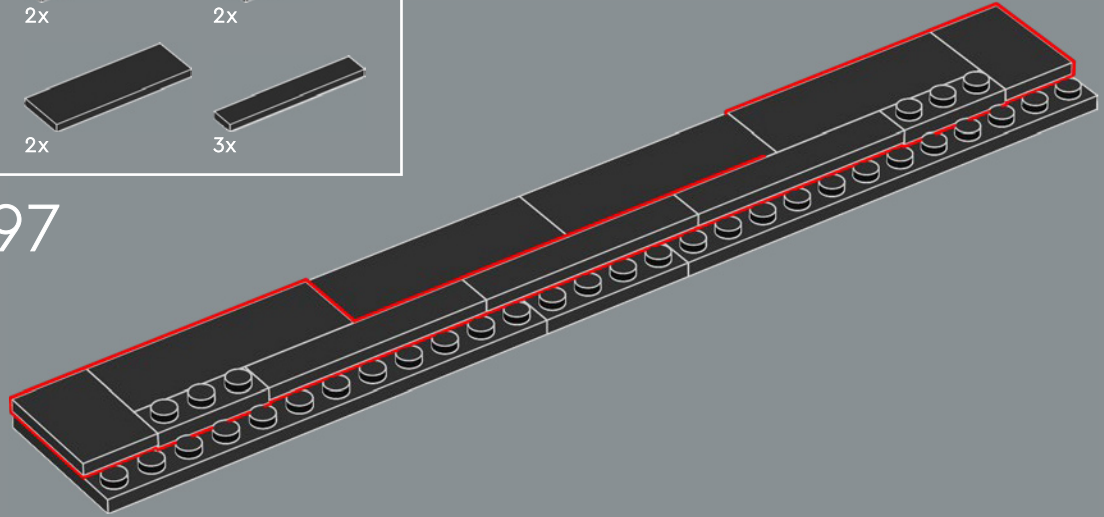



98

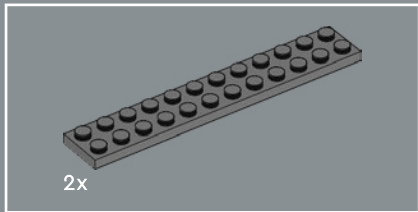
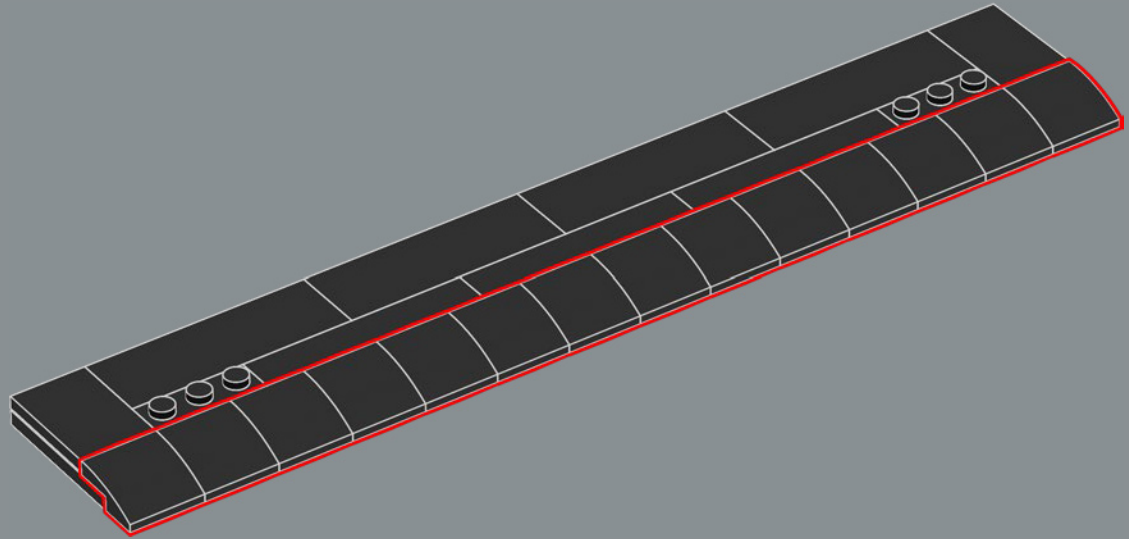

99

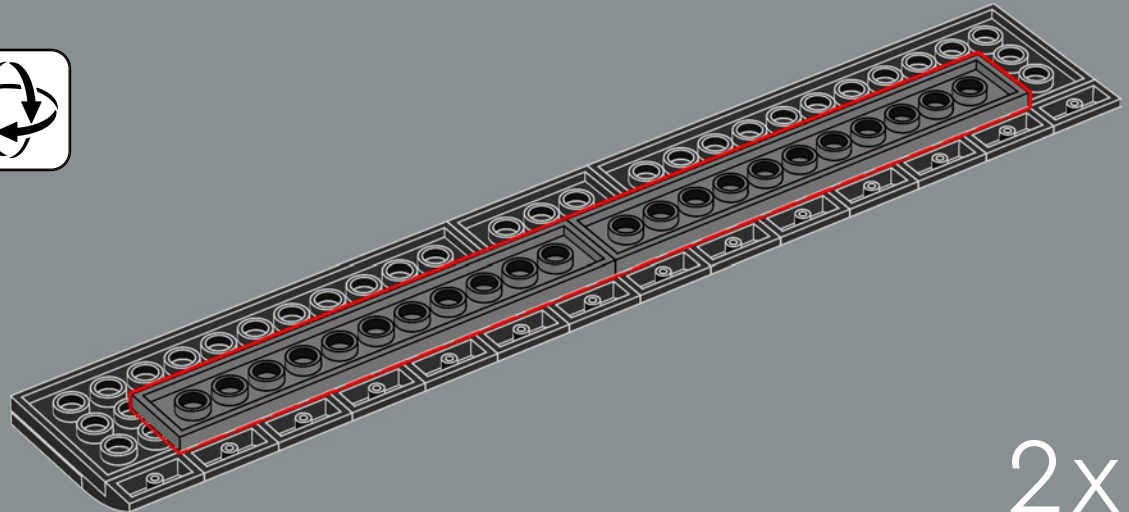

2x

100

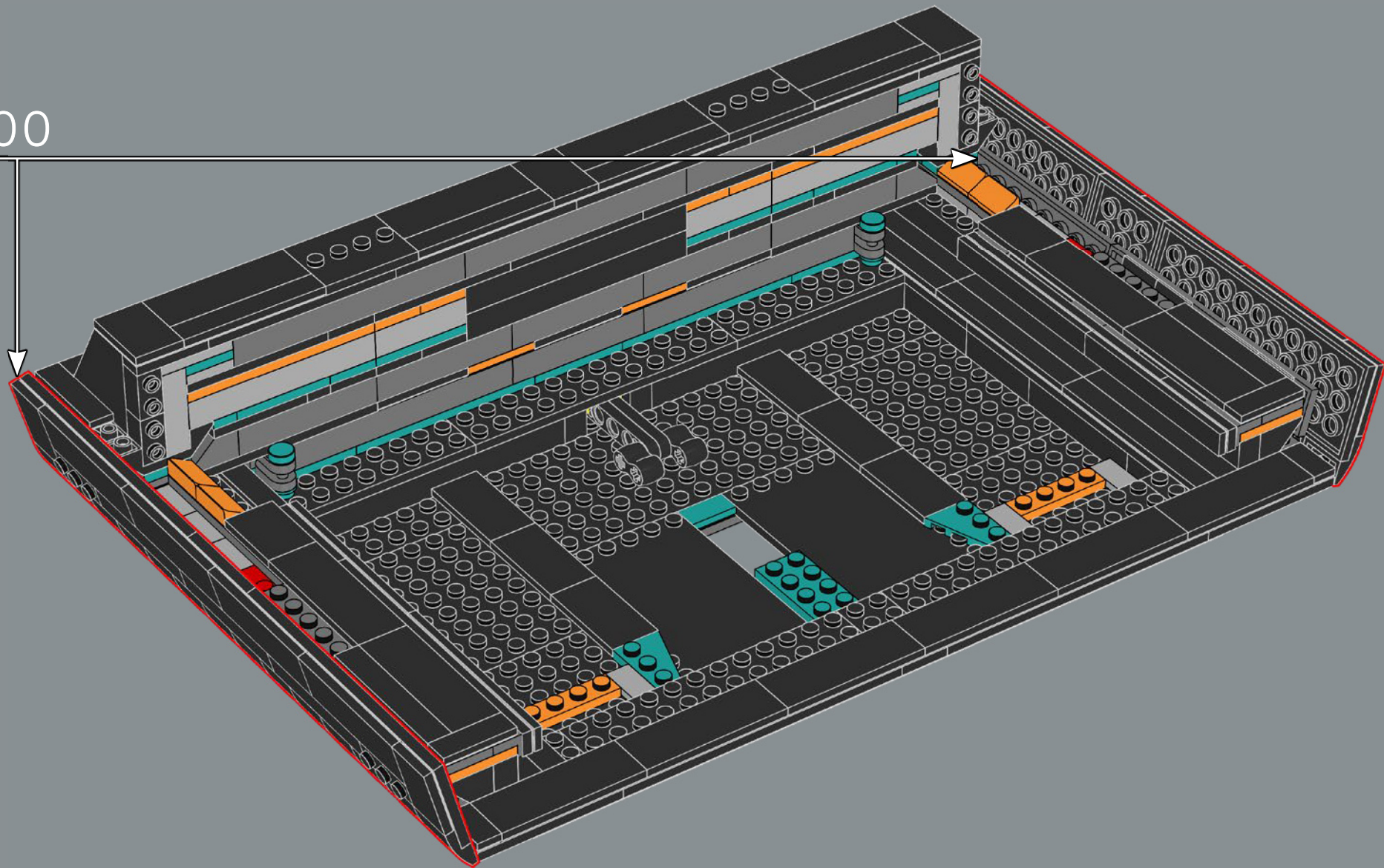

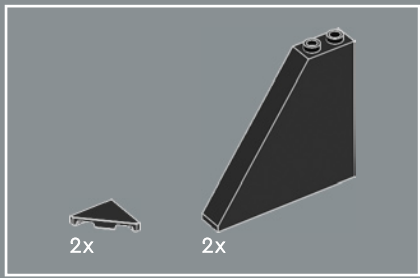

101

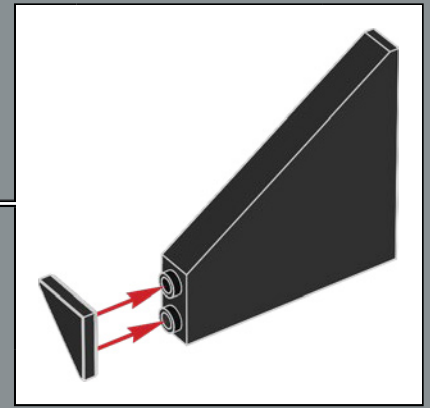
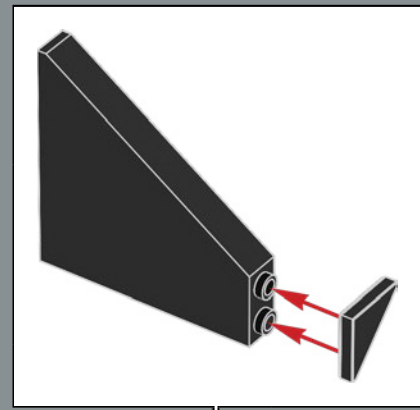
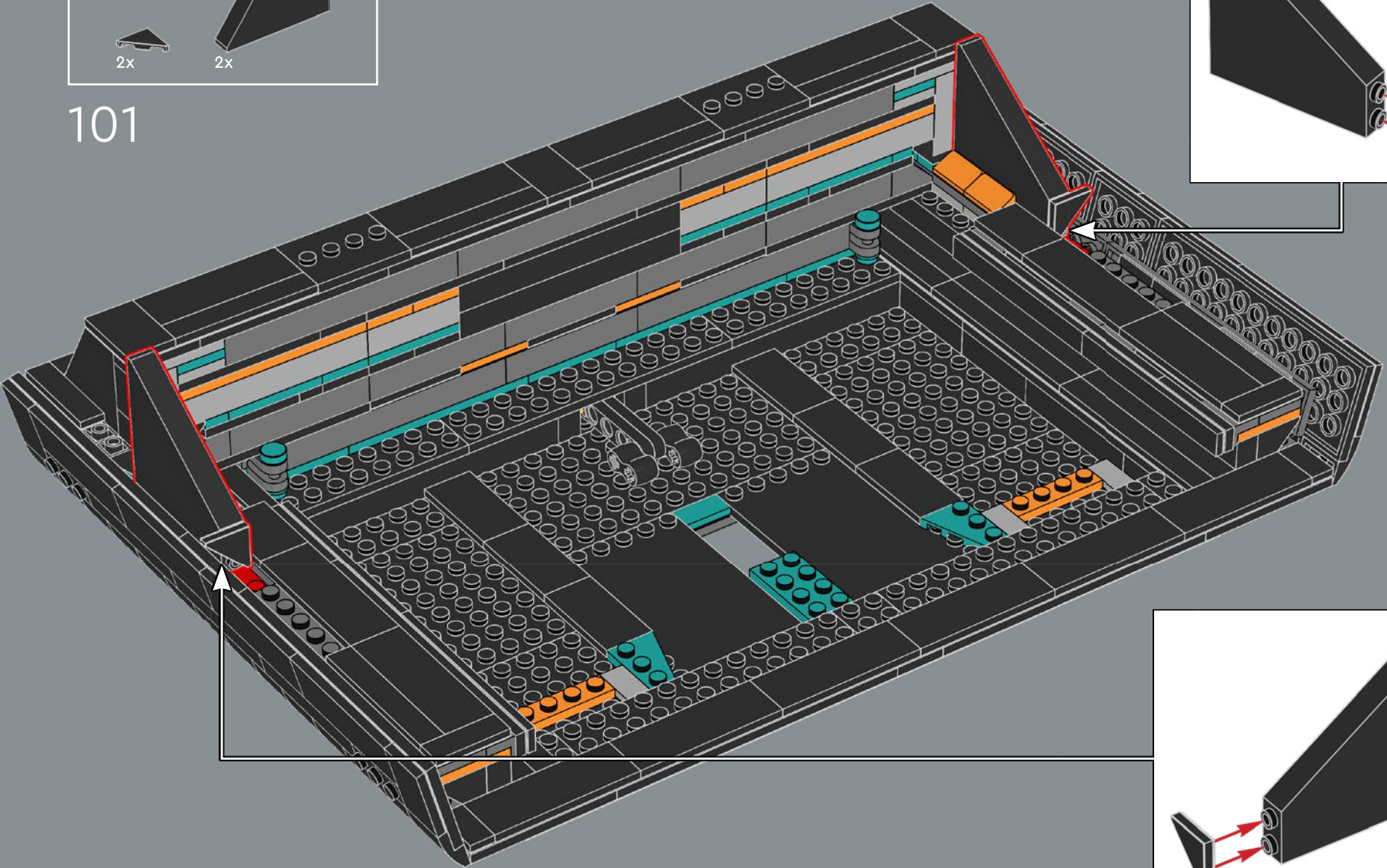

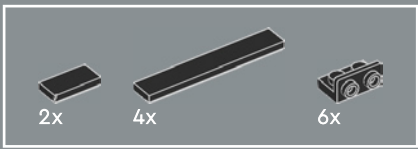

102

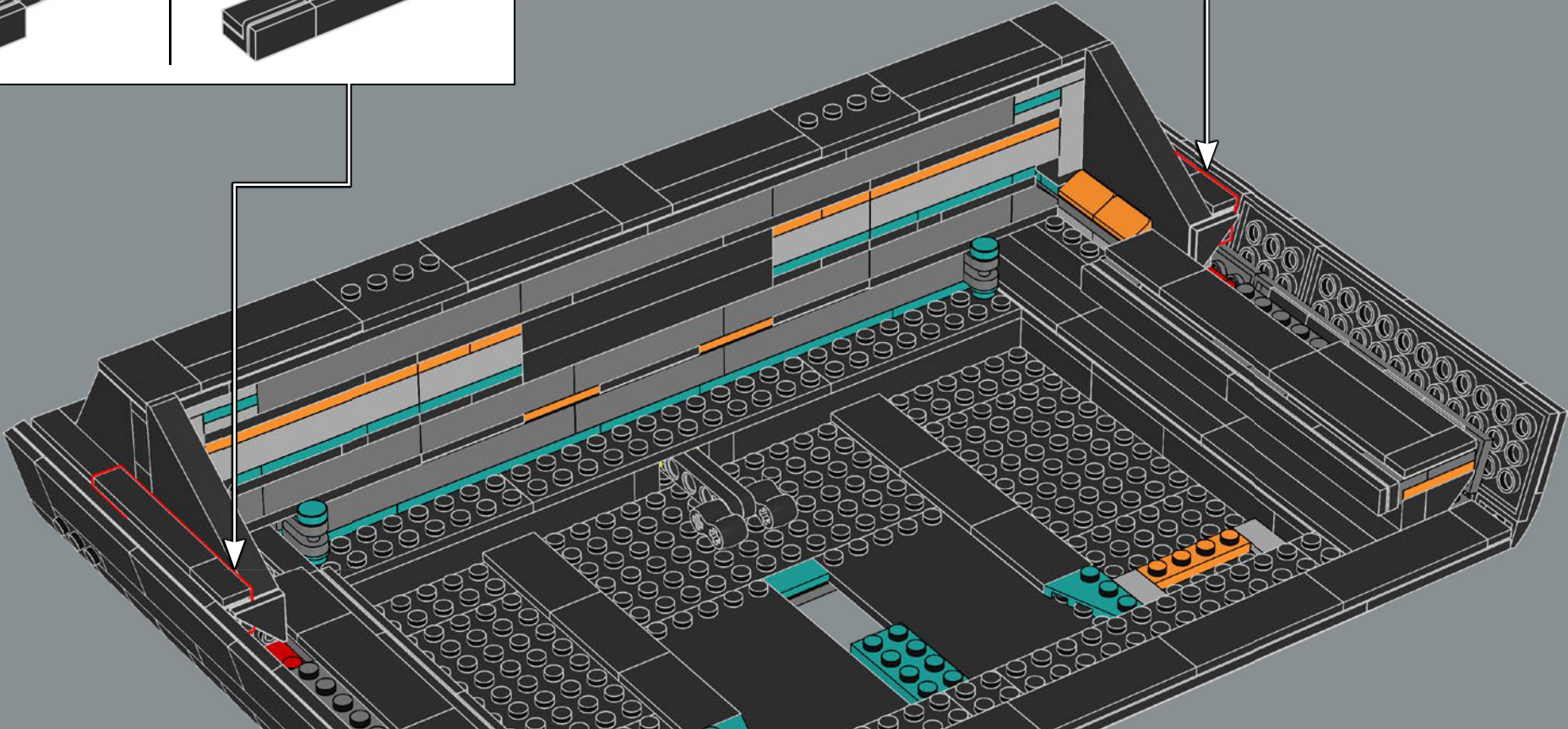
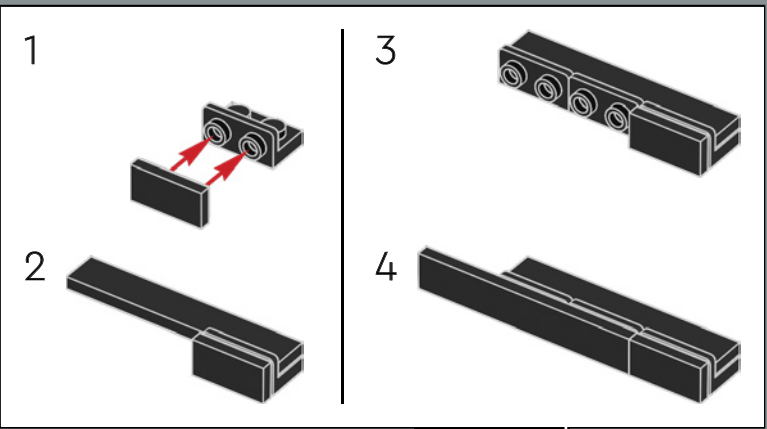
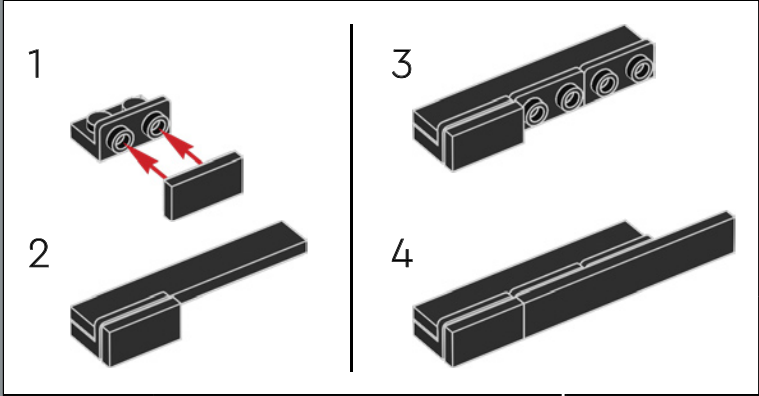

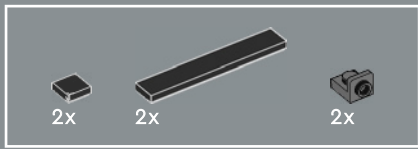

103

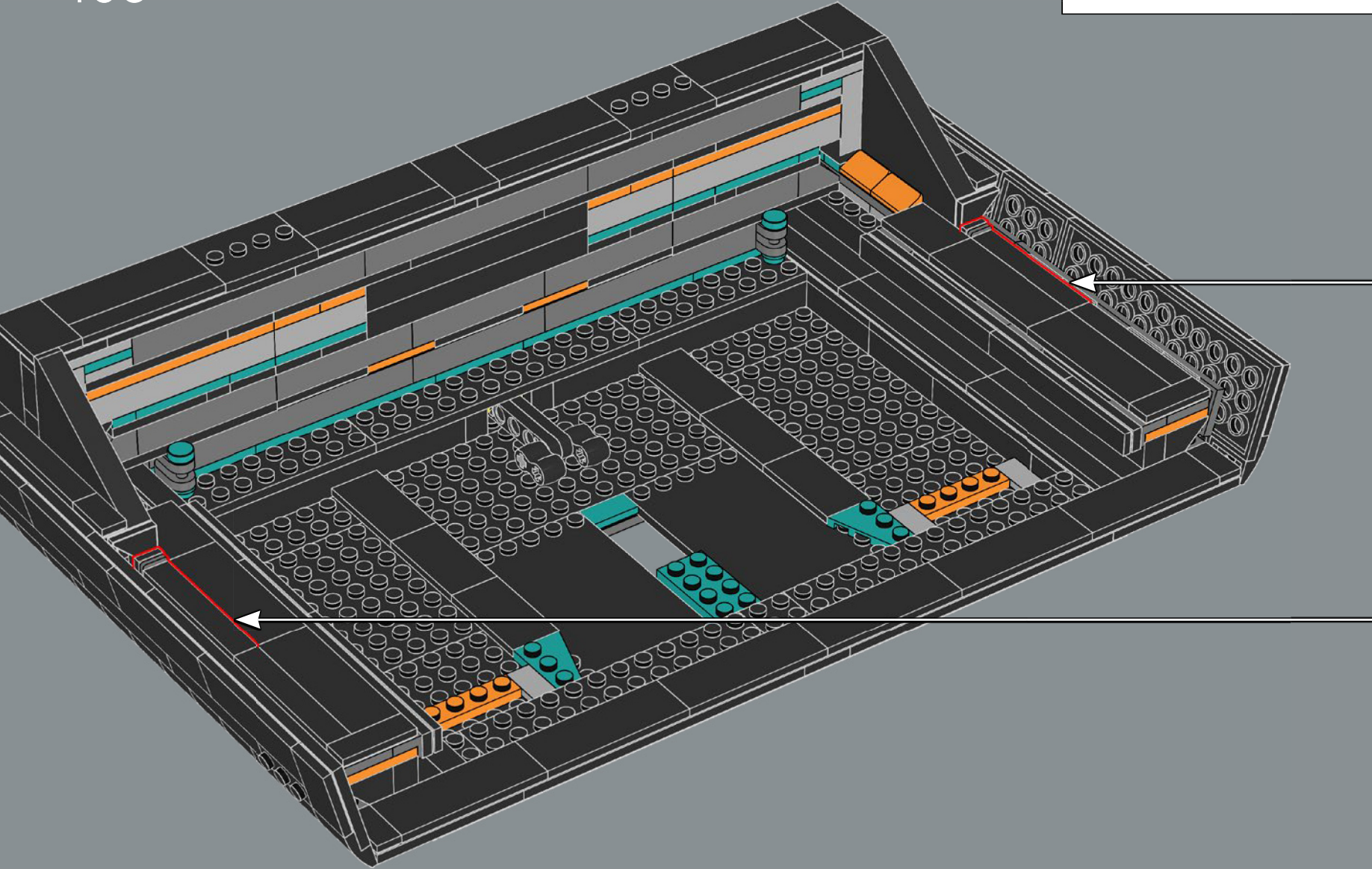
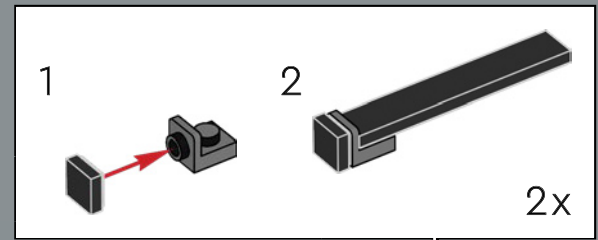

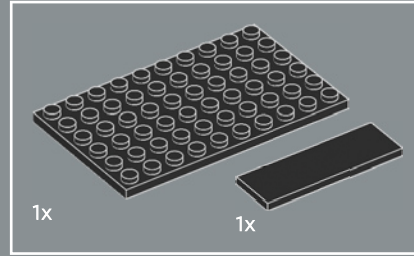
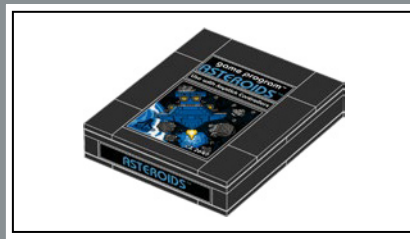

1

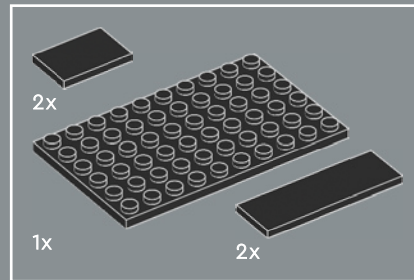
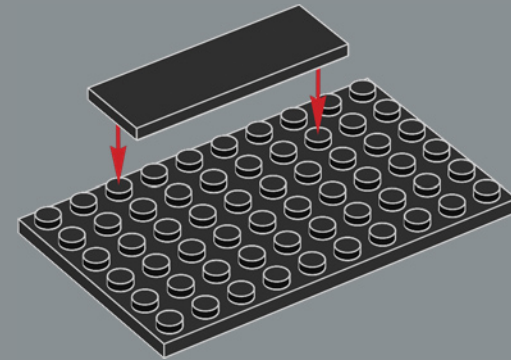

2

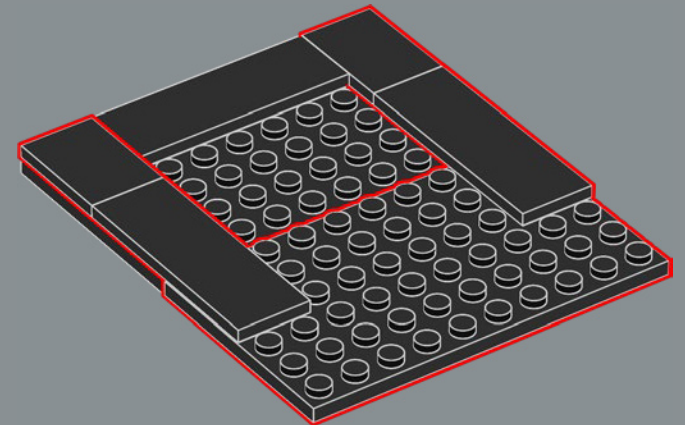

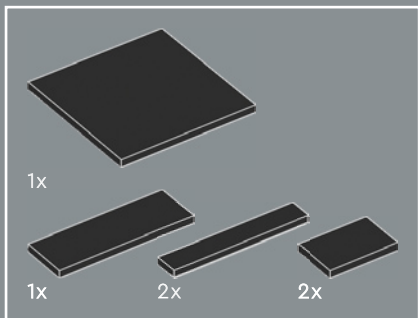

3

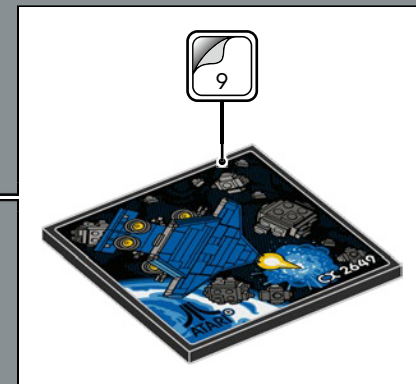
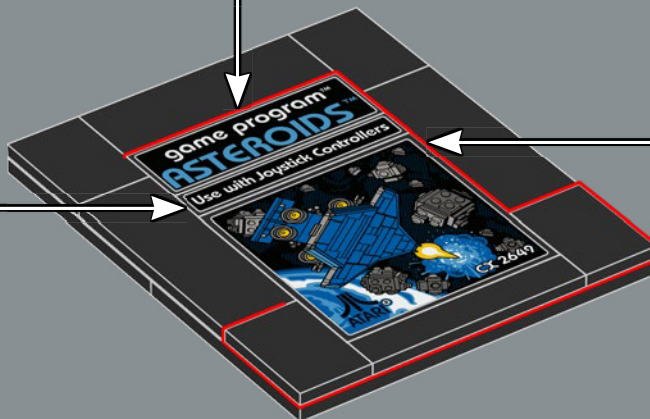
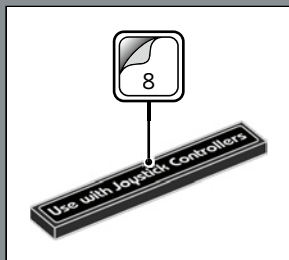

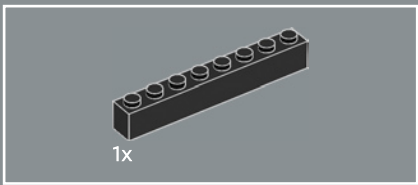

4

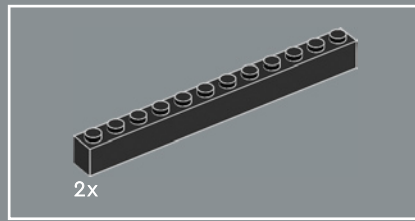
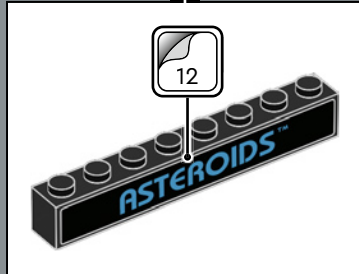
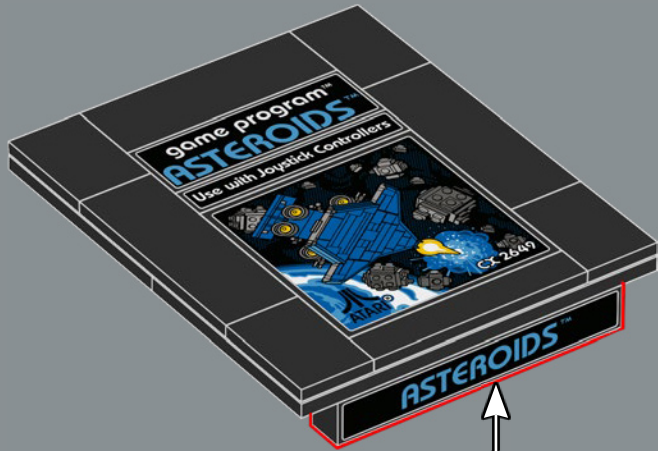

5

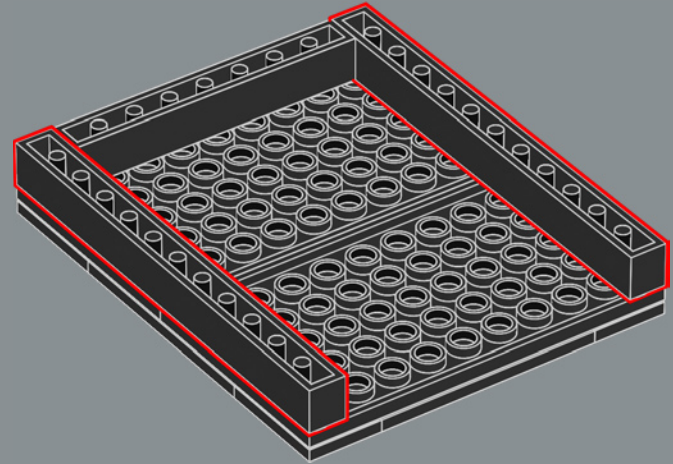

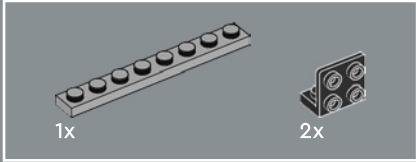
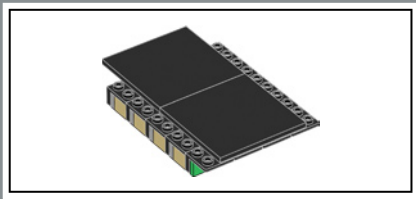

6

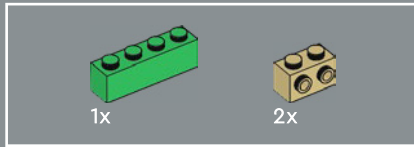
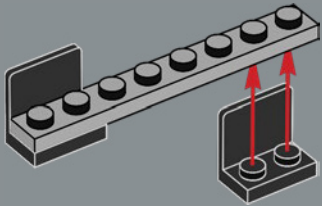

7

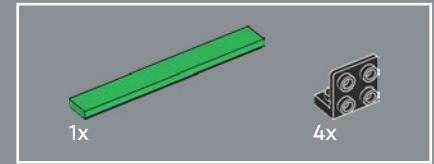
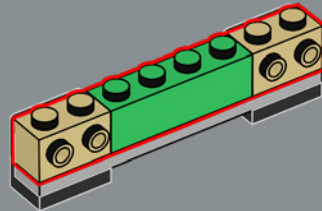

8

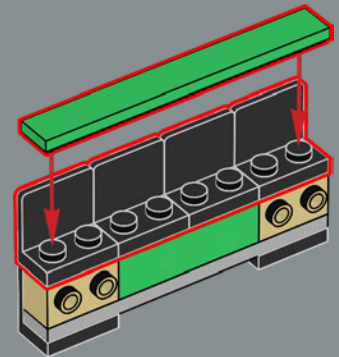

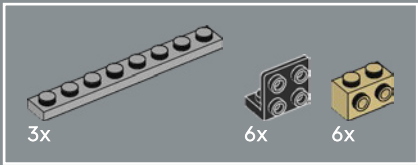

9

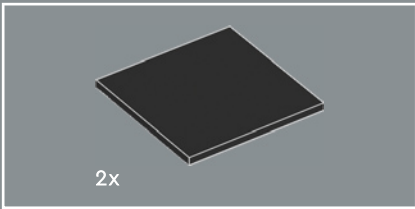
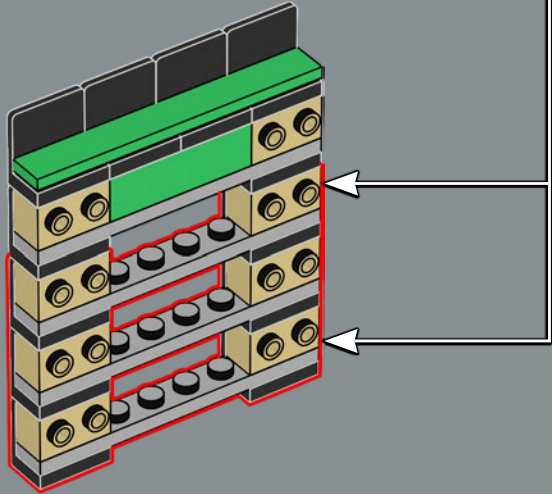
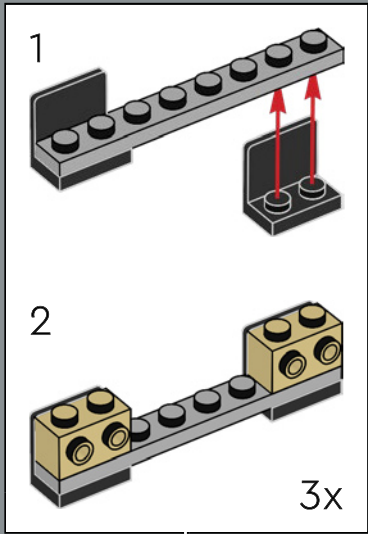

10

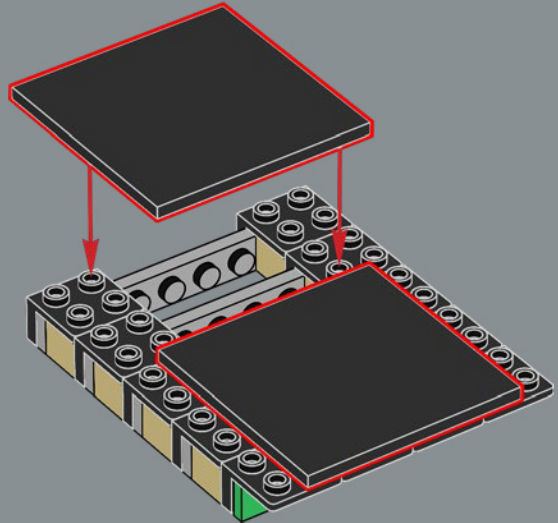

11

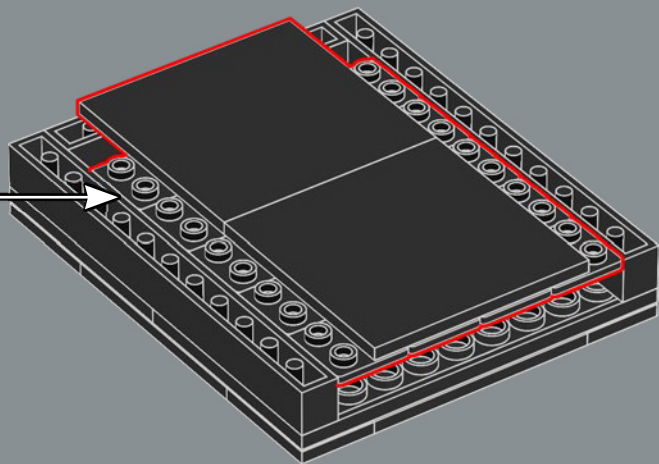

我们对所有卡带艺术品进行了抽象设计，引入了乐高®元素，其中《爆破彗星》艺术品尤其特殊，因为它包含新款乐高产品 10497 银河探索号。



12

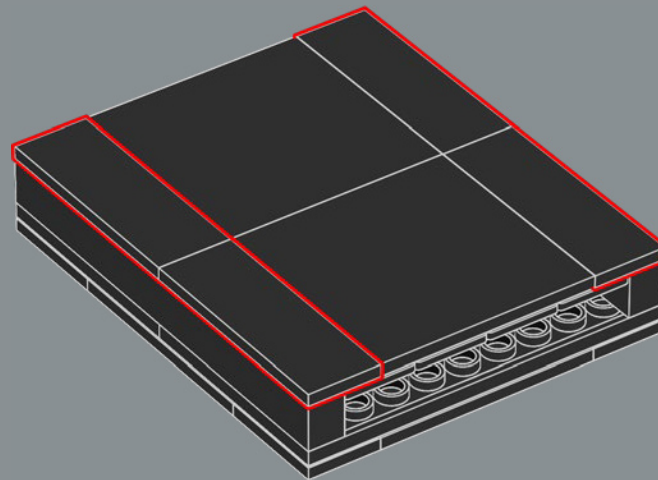
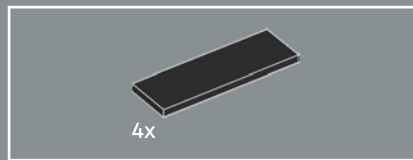

13



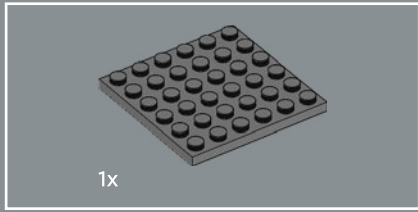
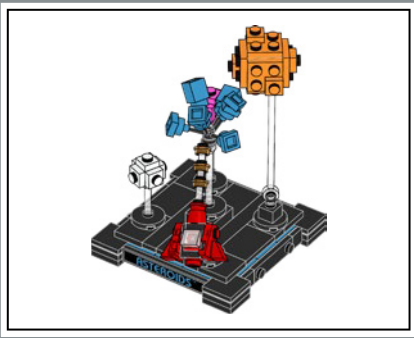

1x

1

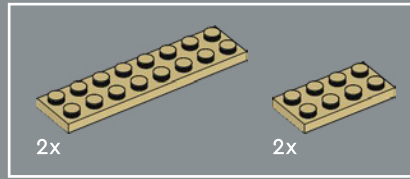
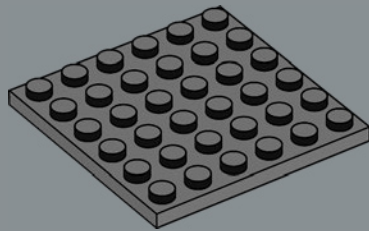

2x

2x

2

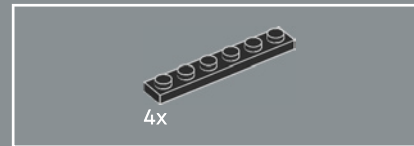
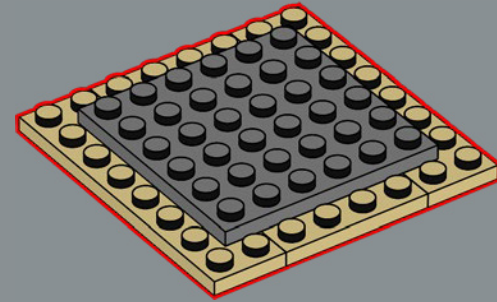

4x

3

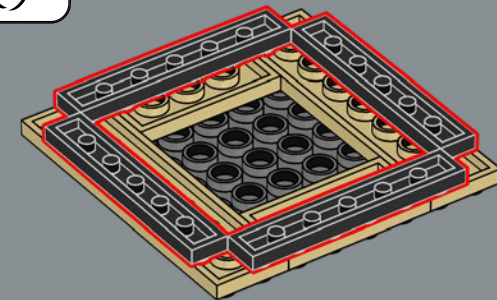

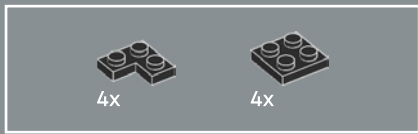

4

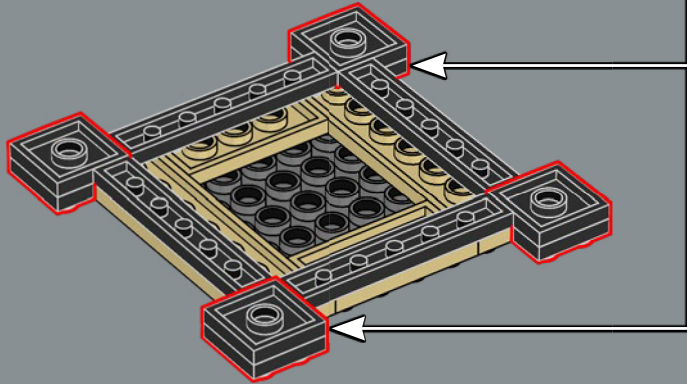
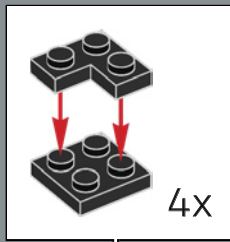

5

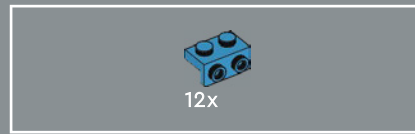
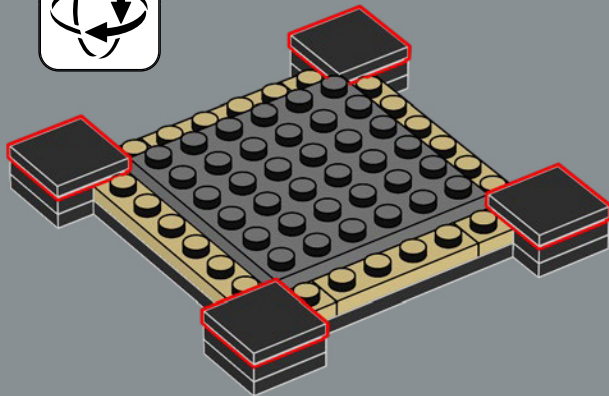

6

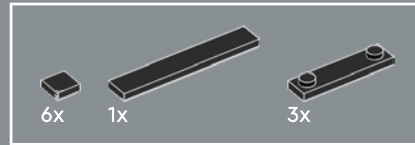
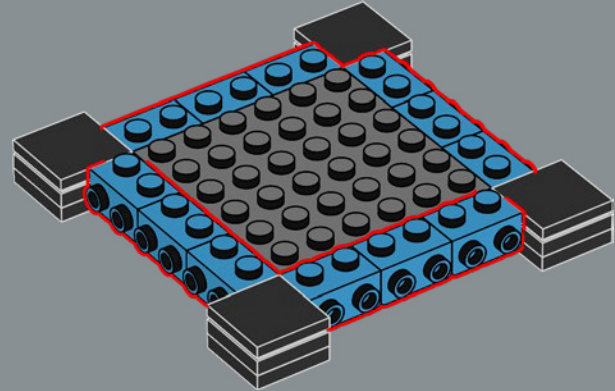

7

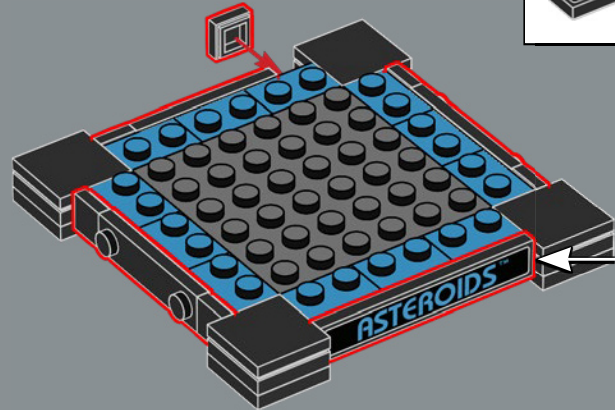
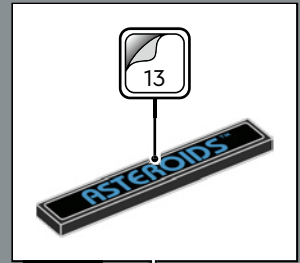

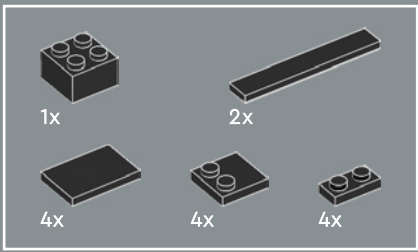

8

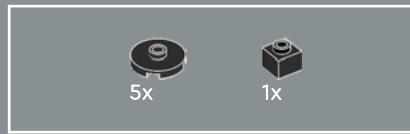
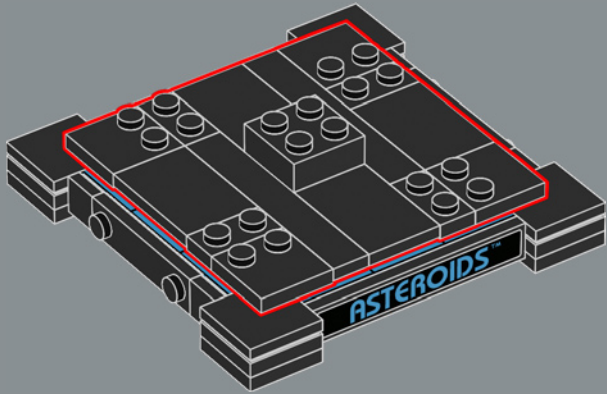

9

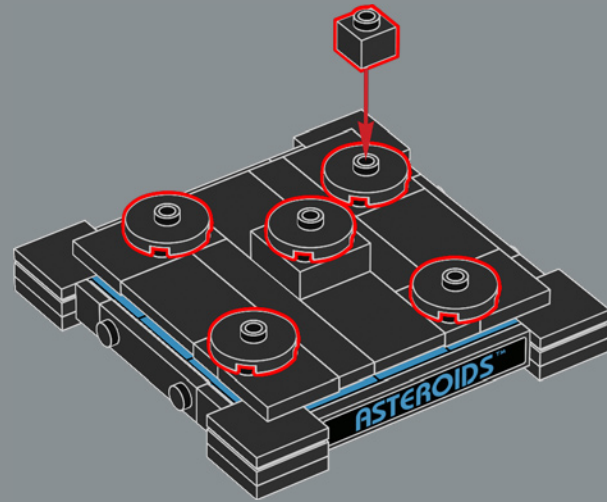

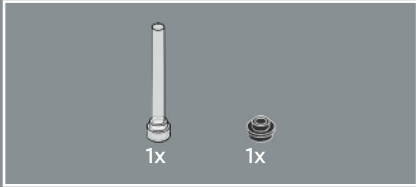
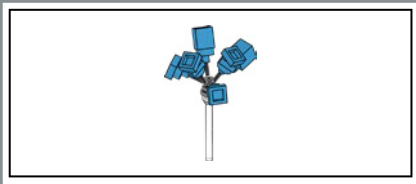

10



11

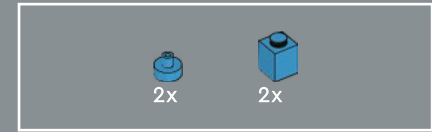
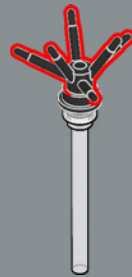

12

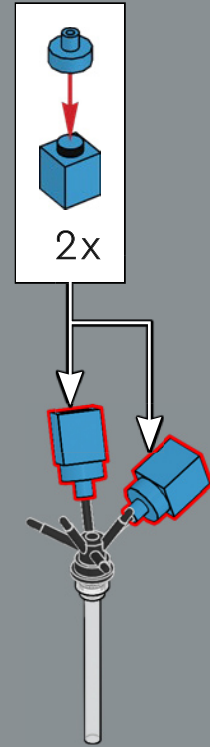

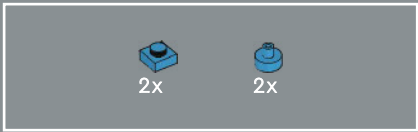

13

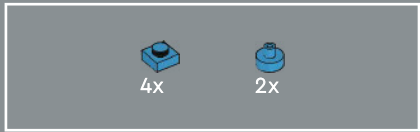
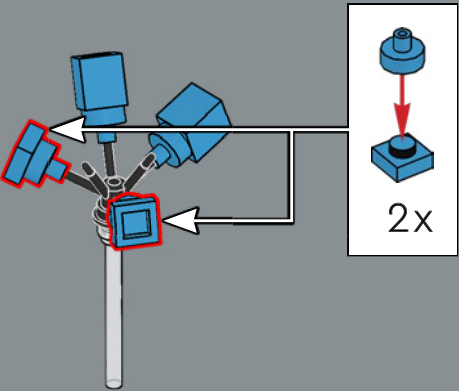

14

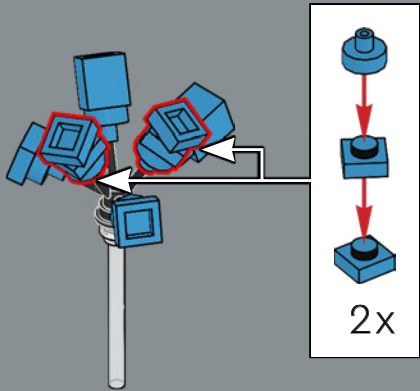

15

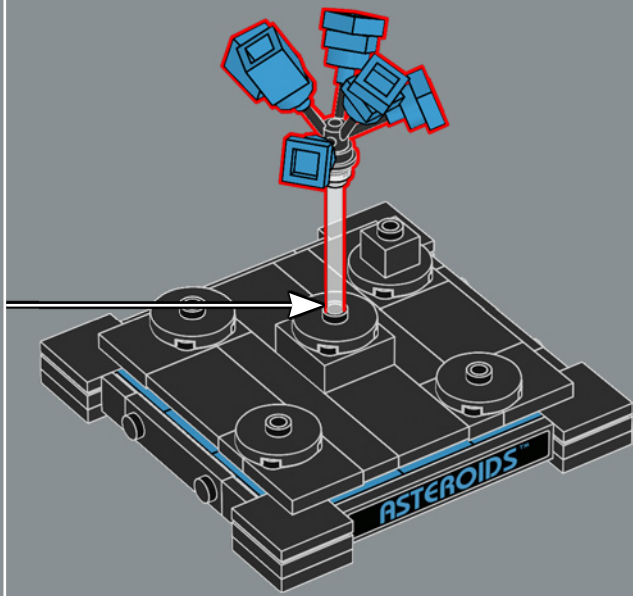

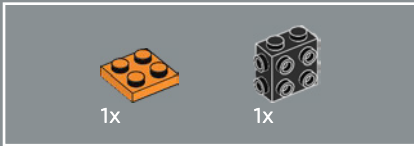
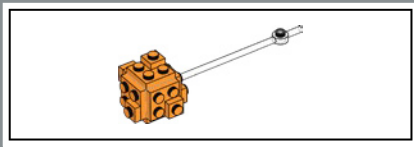

16

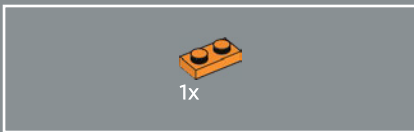
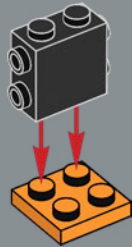

17

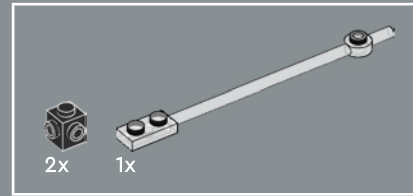
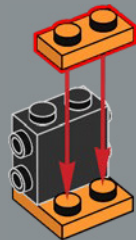

18

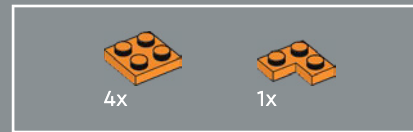
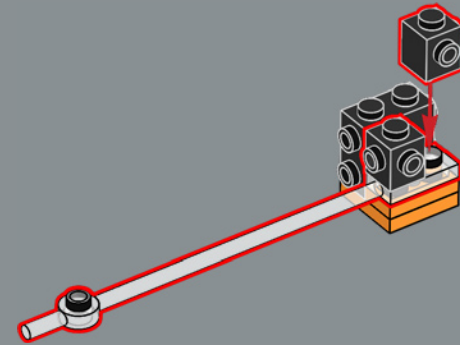

19

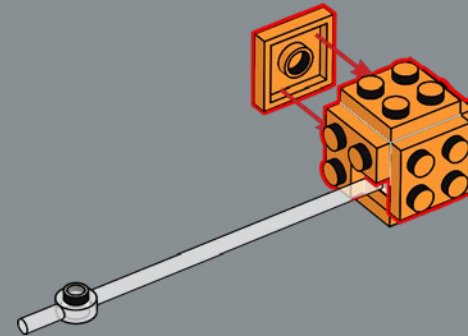



3x

20

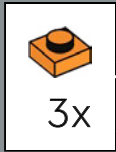

3x

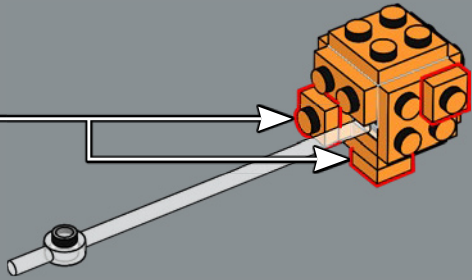

3x

21

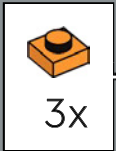

3x

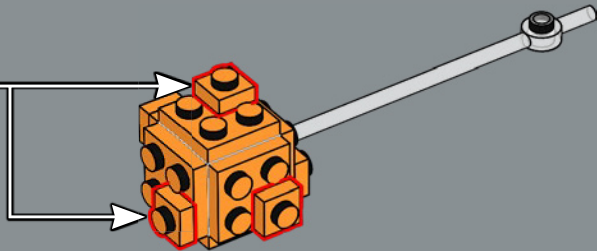

22

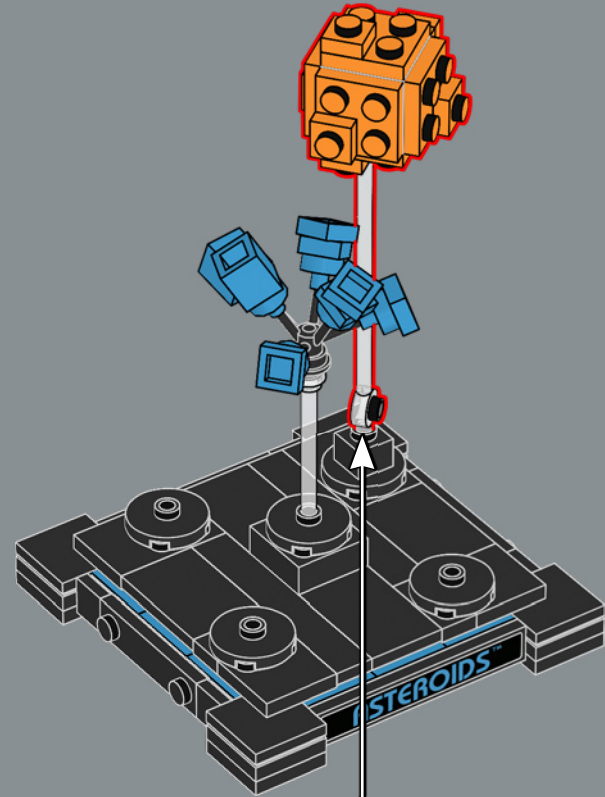



23

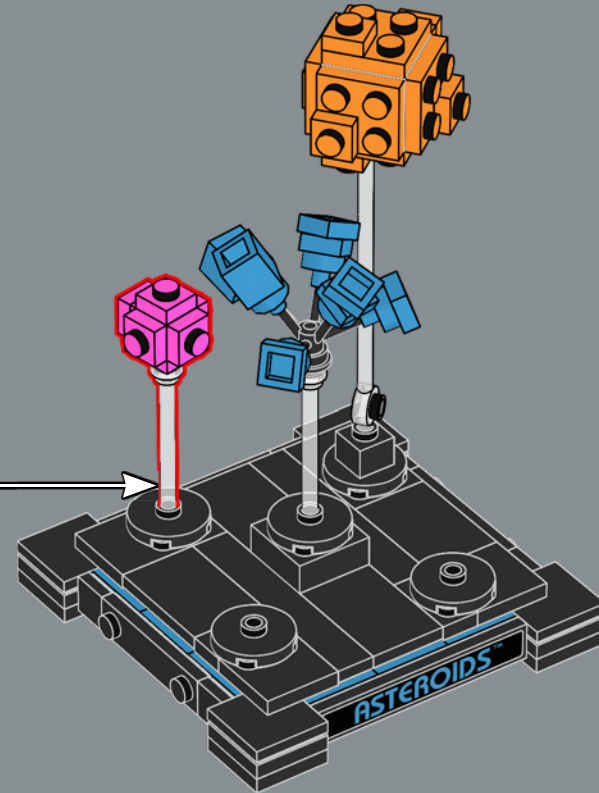
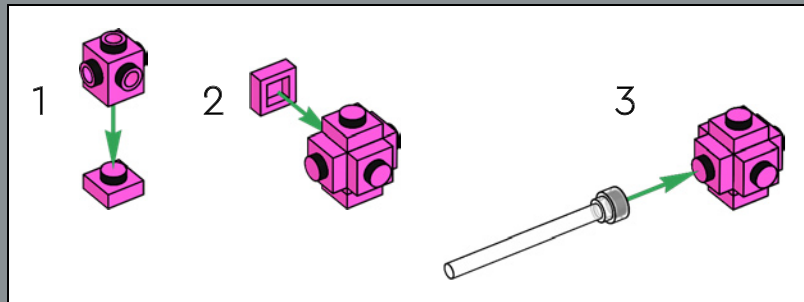

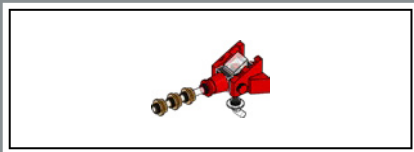

25

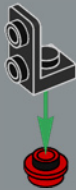

26

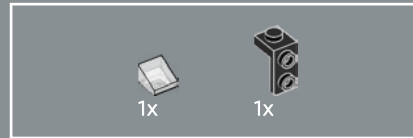

27

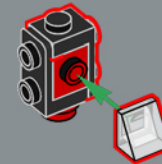

28





2x

29

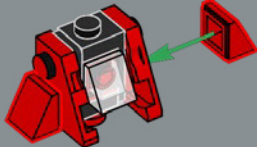

1x



1x

30

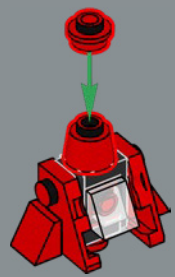

1x

31



3x

32



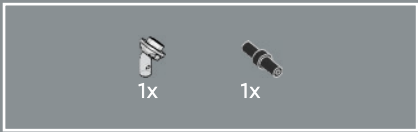

33

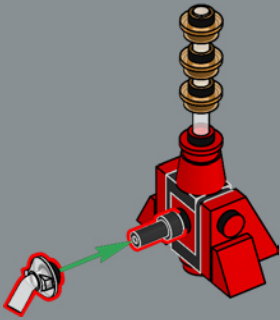

34

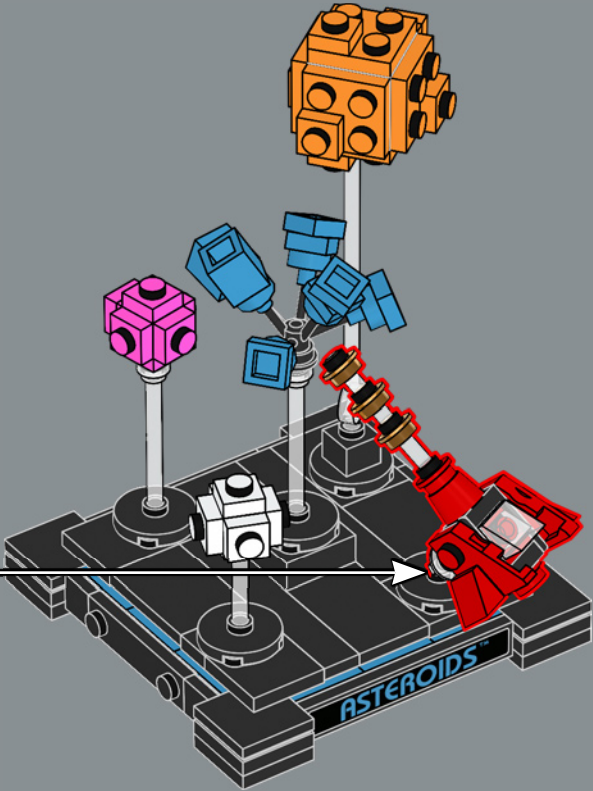

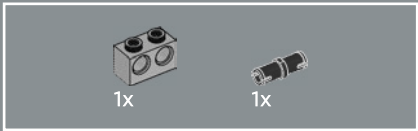
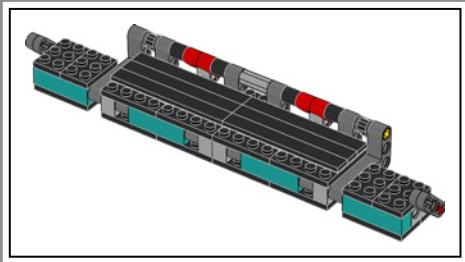

104

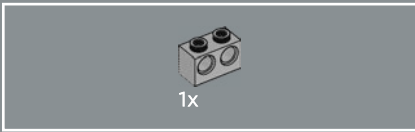
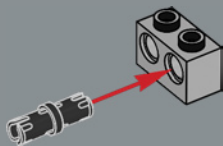

105

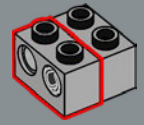

106

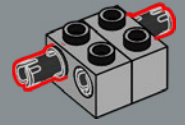

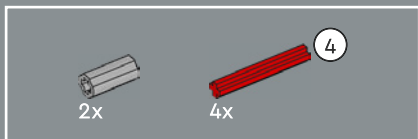

111

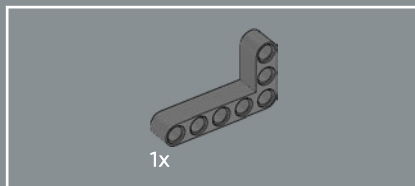
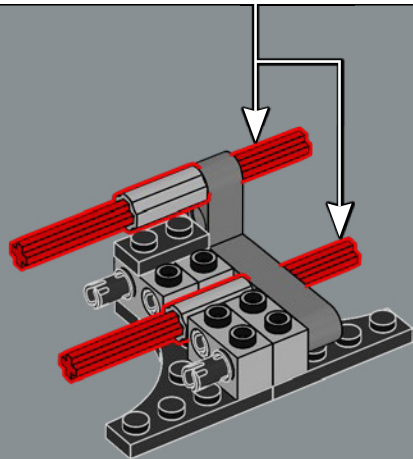
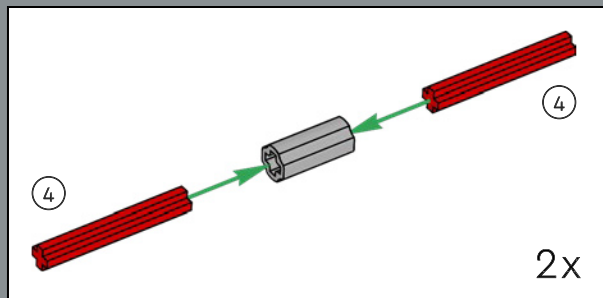

112

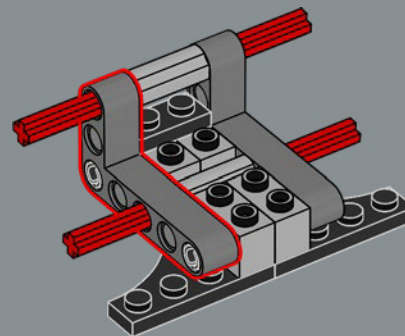

113

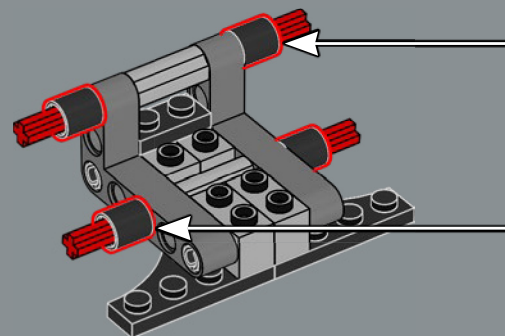



114

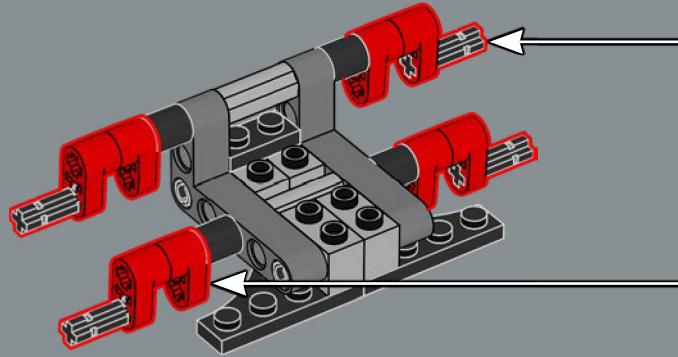
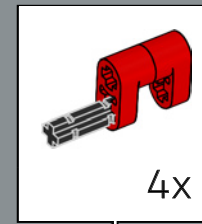

115

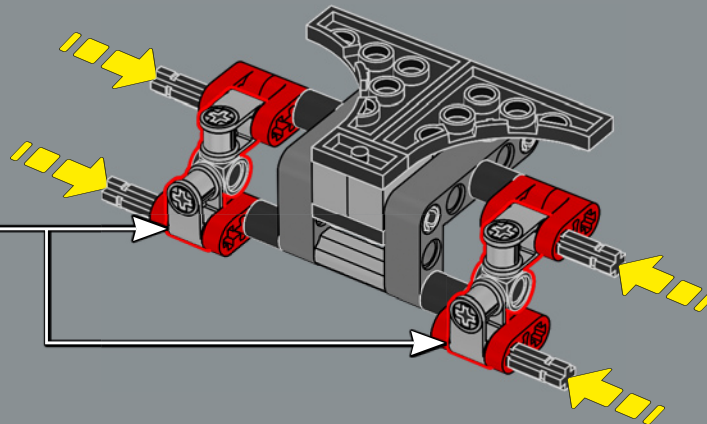
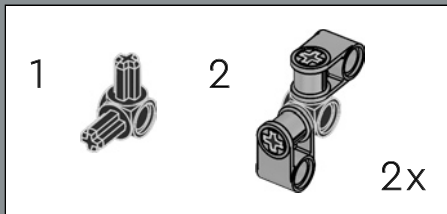

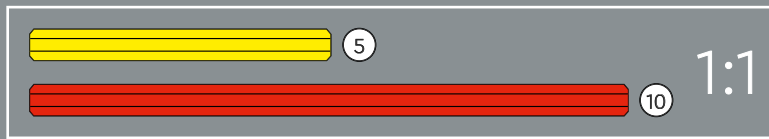
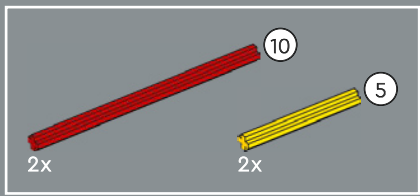

116

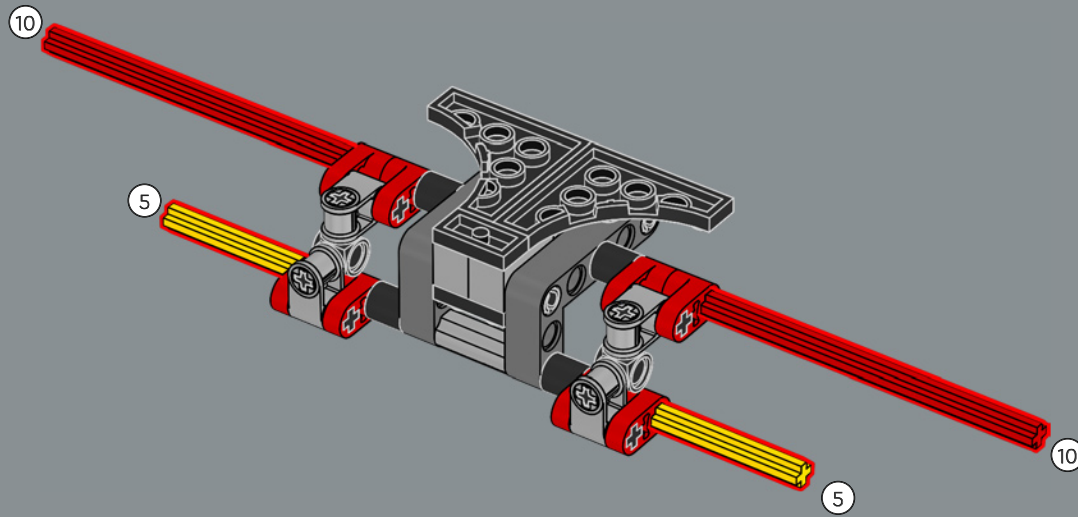

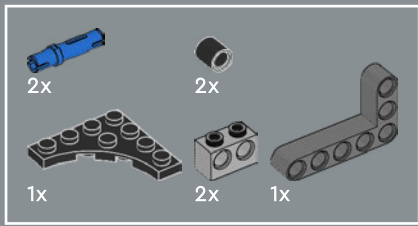

117

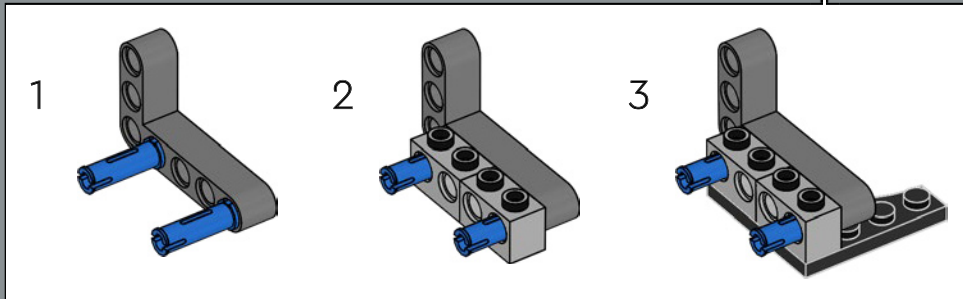
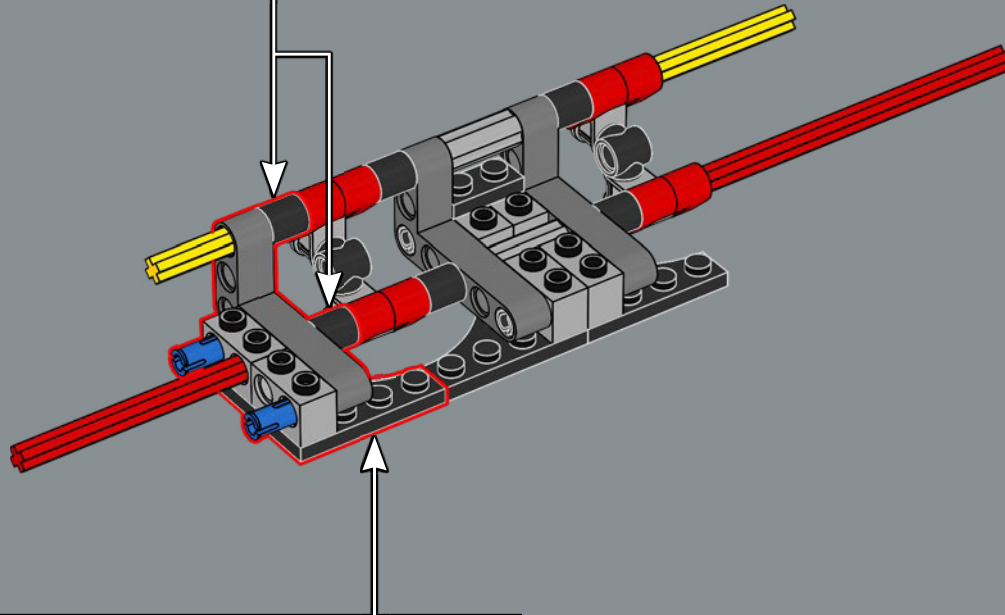

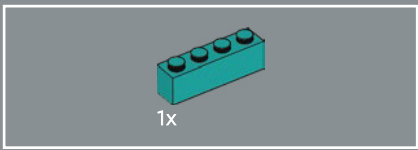

118

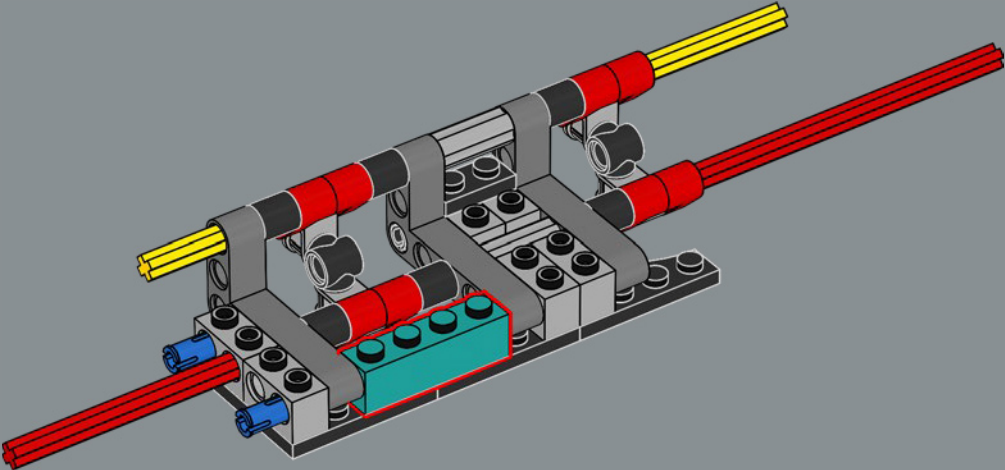

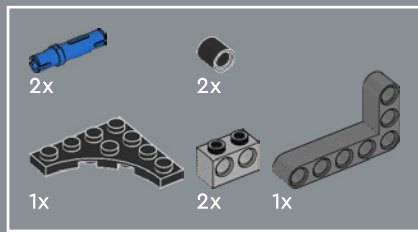

119

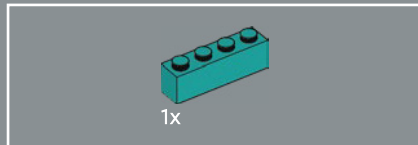
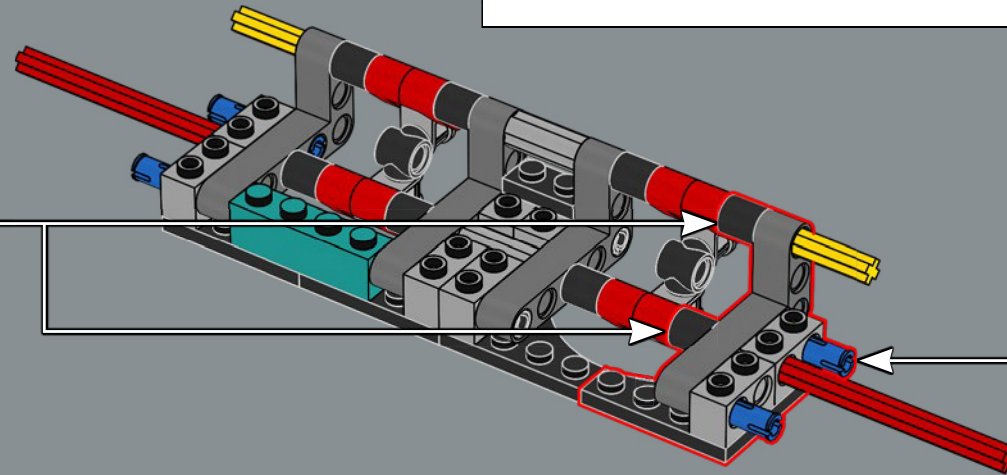
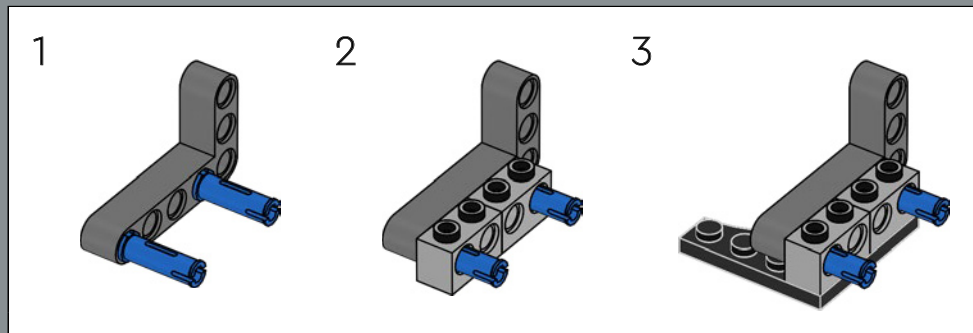

120

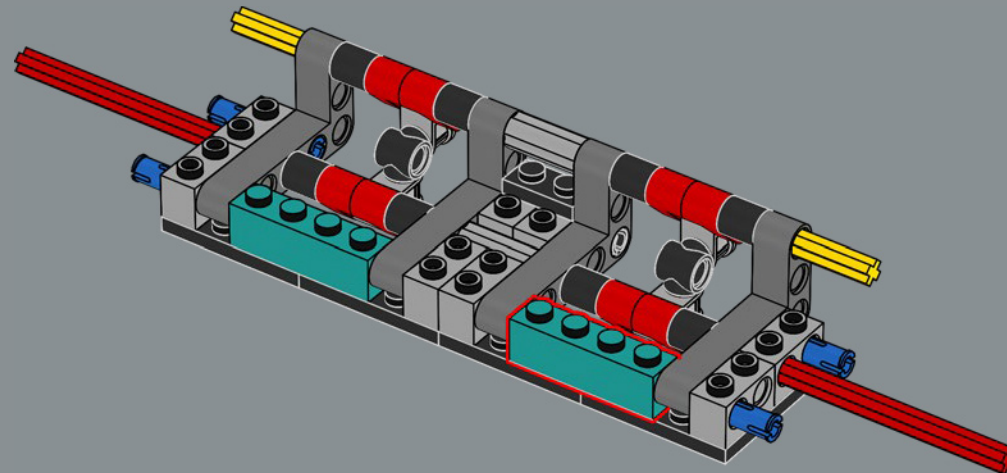

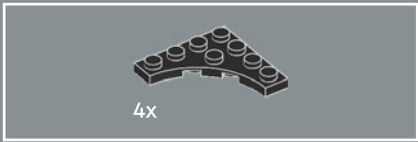

121

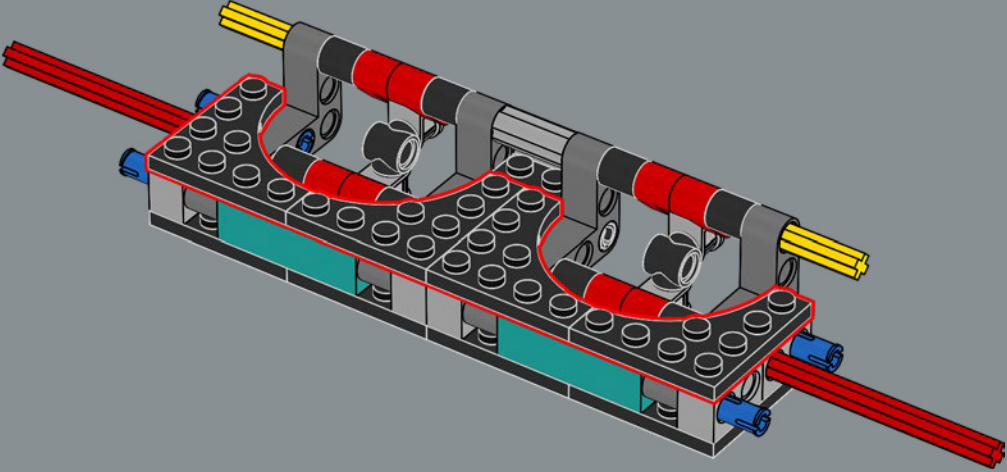

122

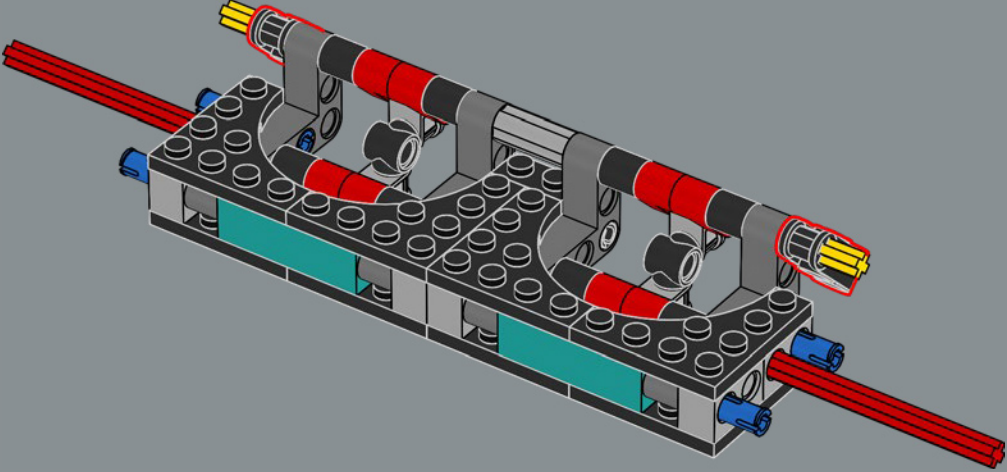

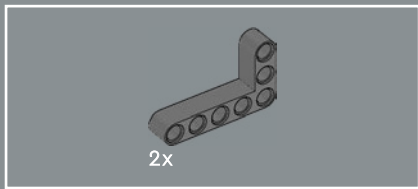

123

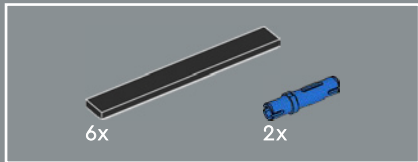
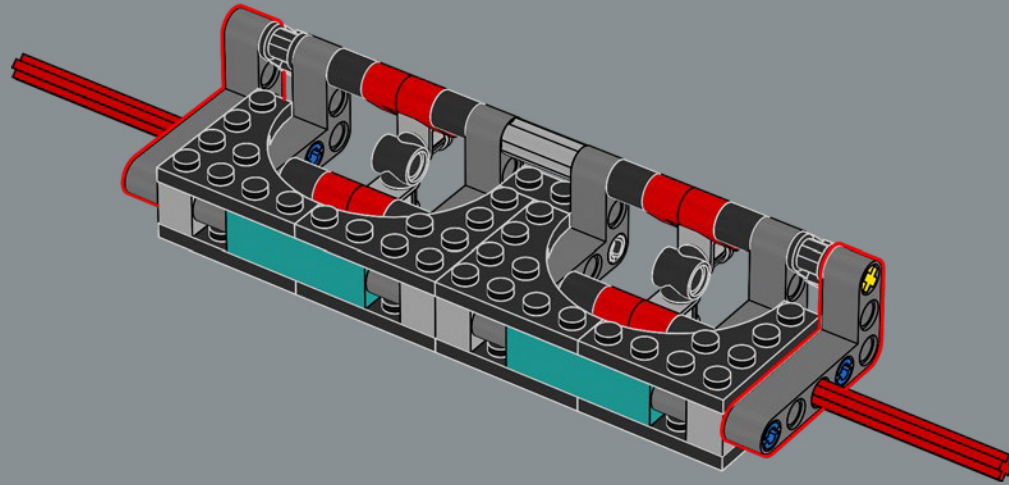

124

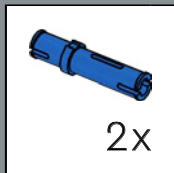
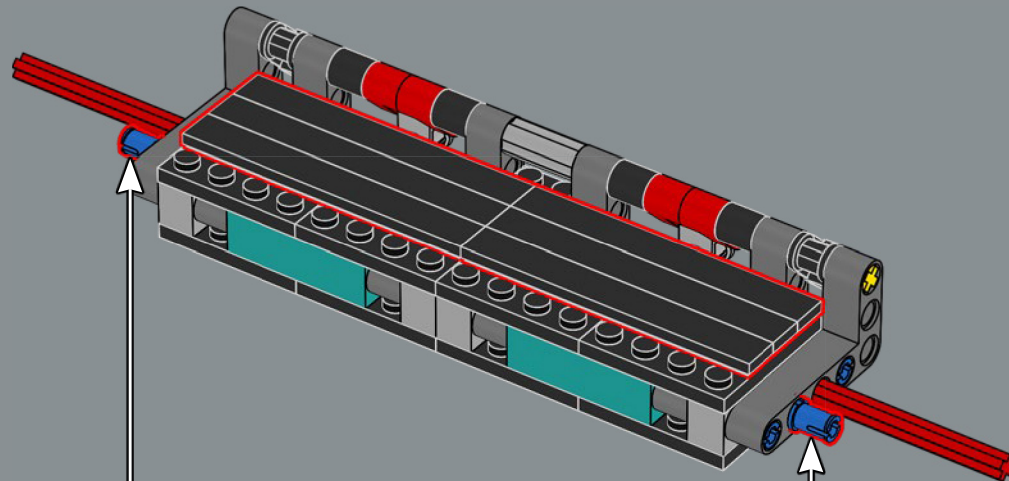

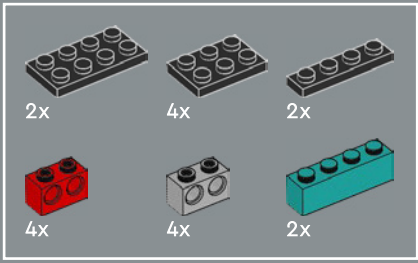

125

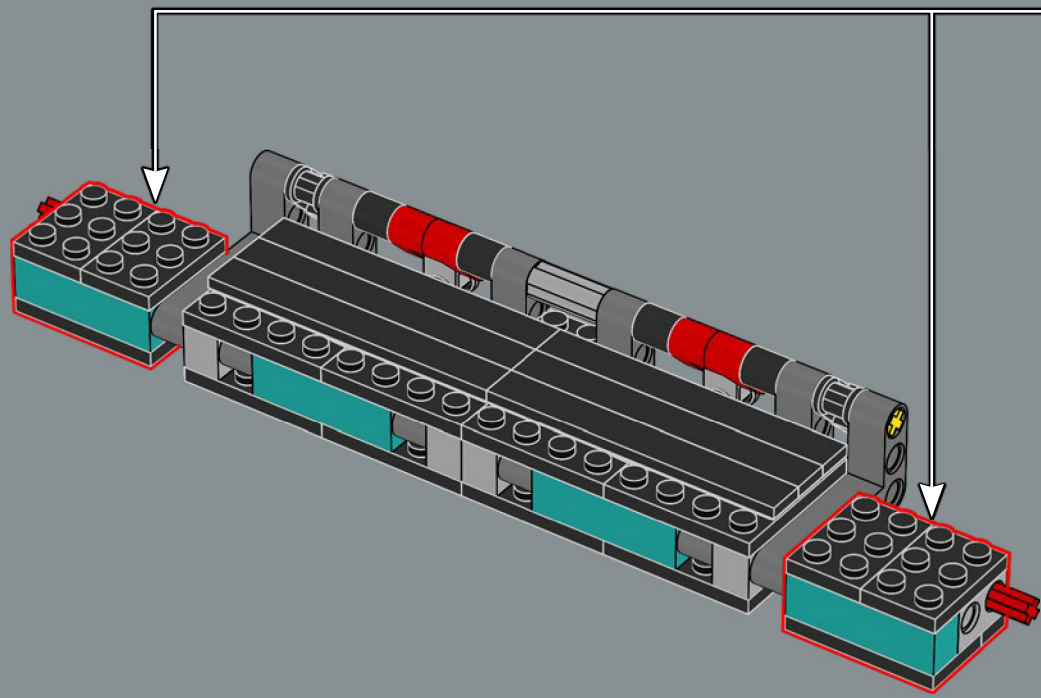
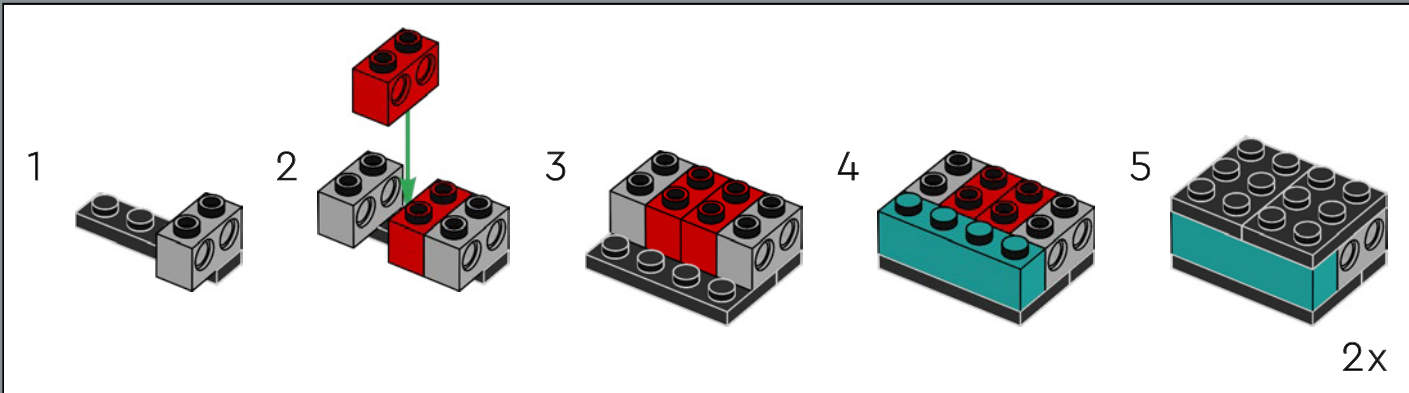



126

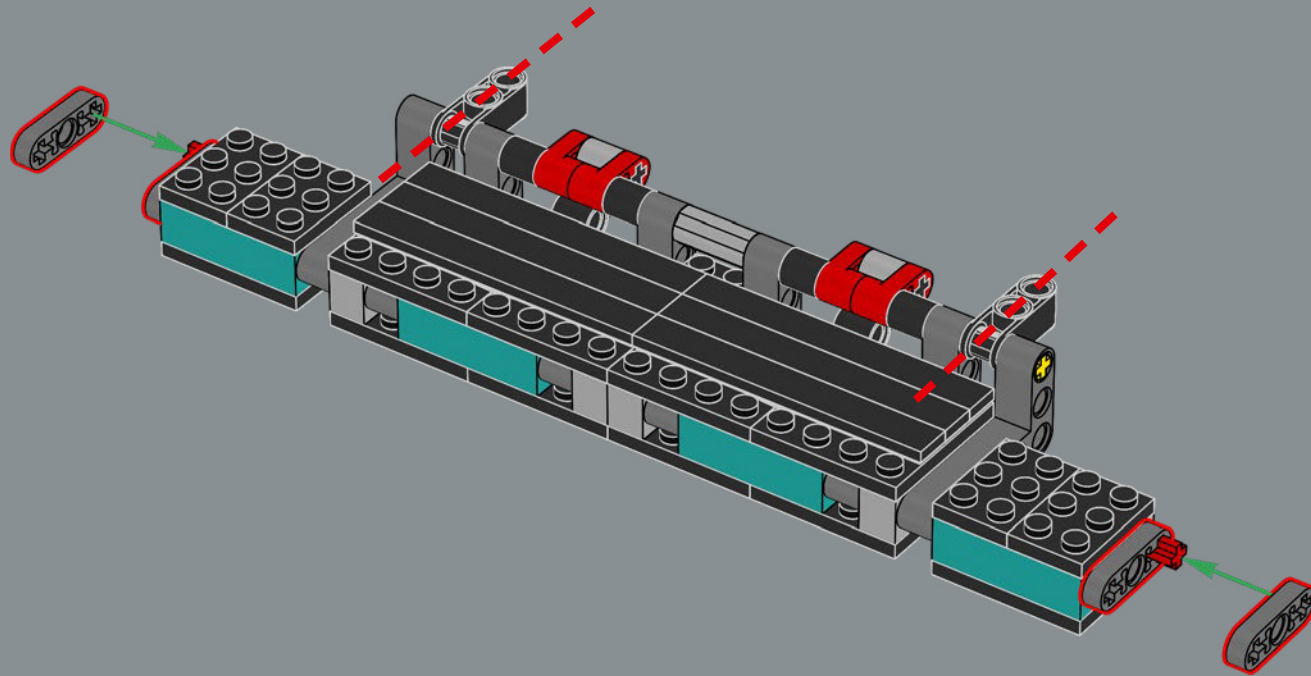

127

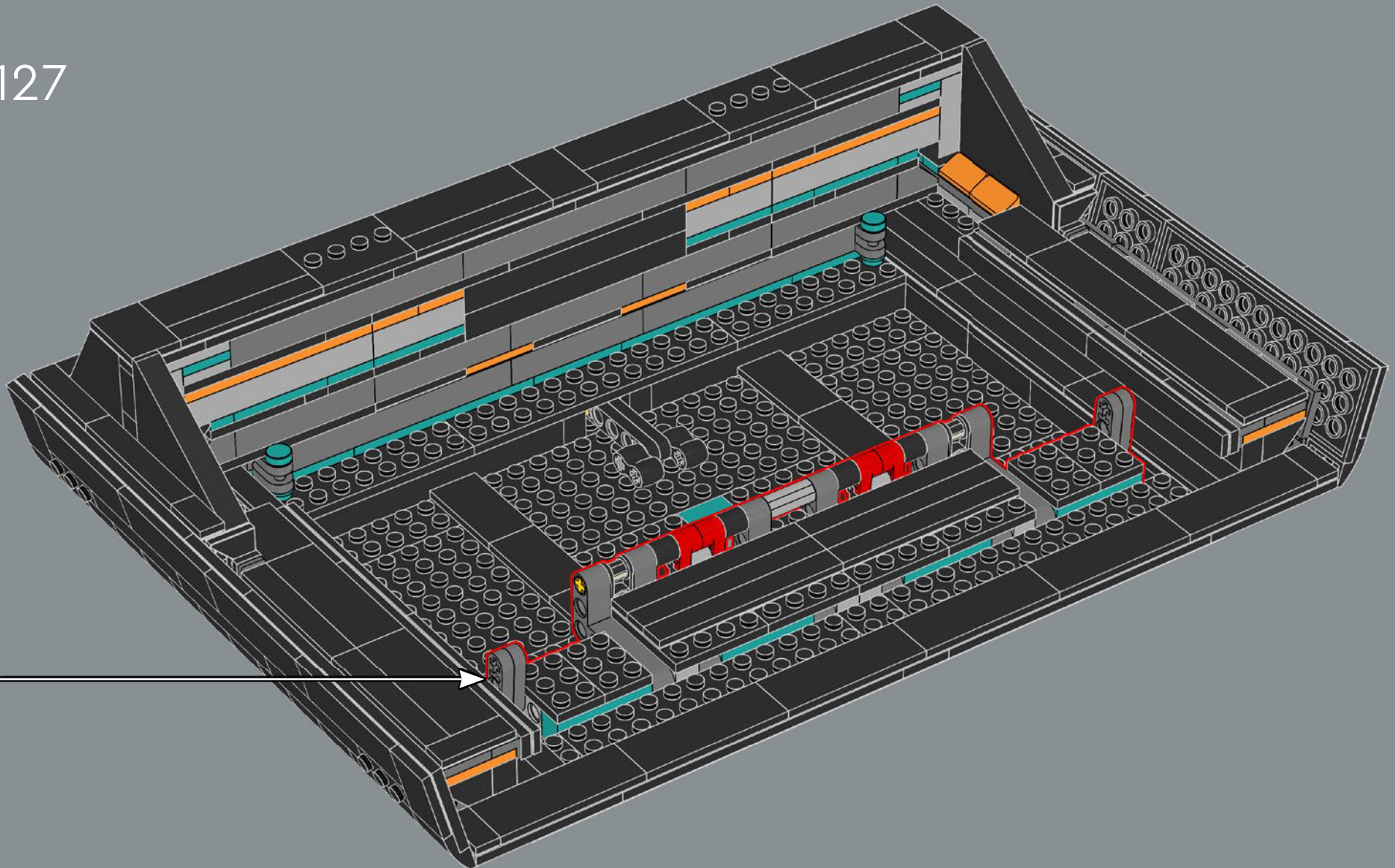

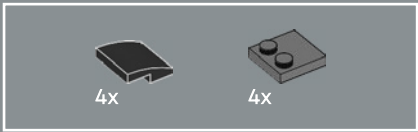

128

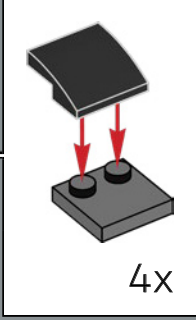
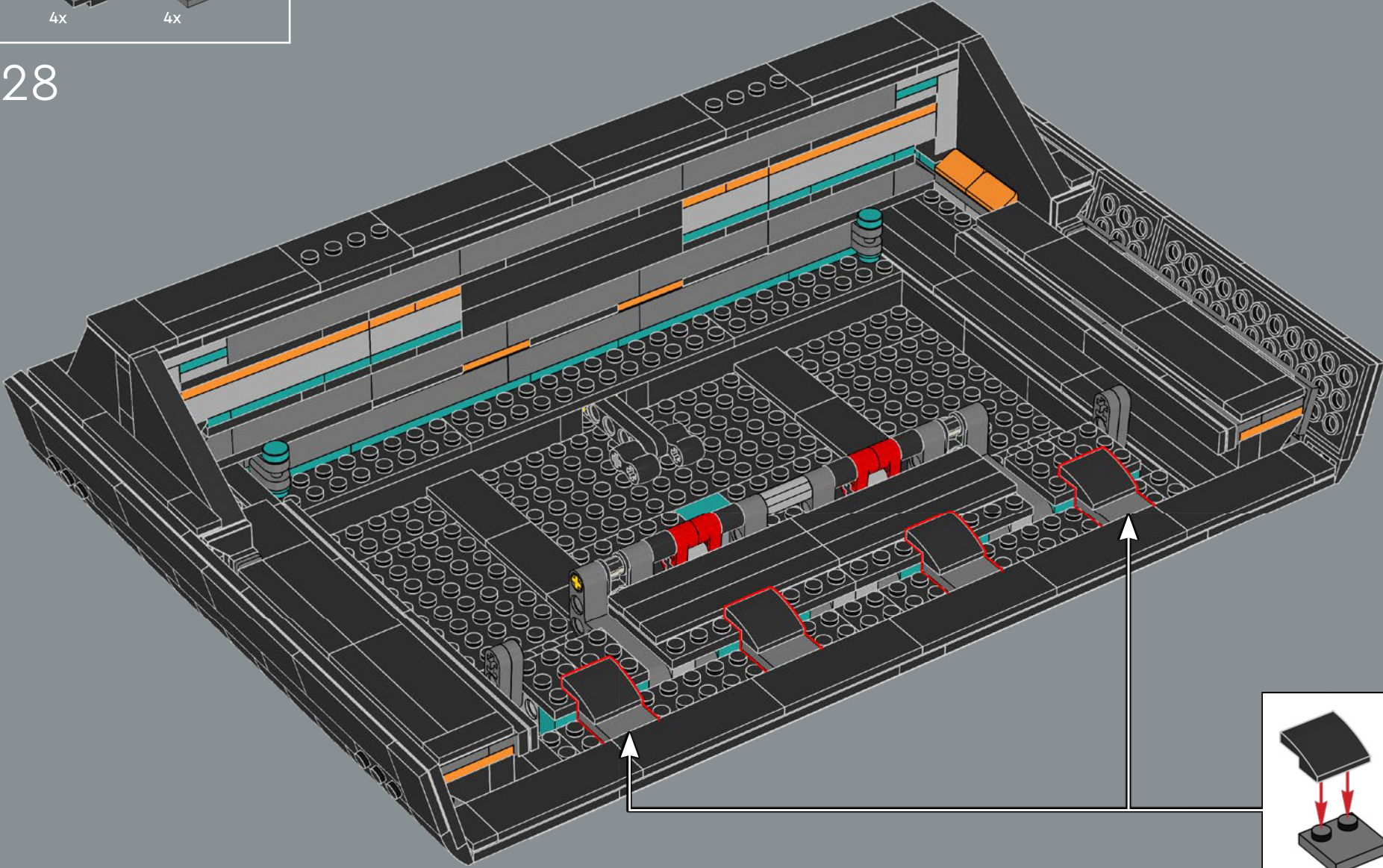



4x

129

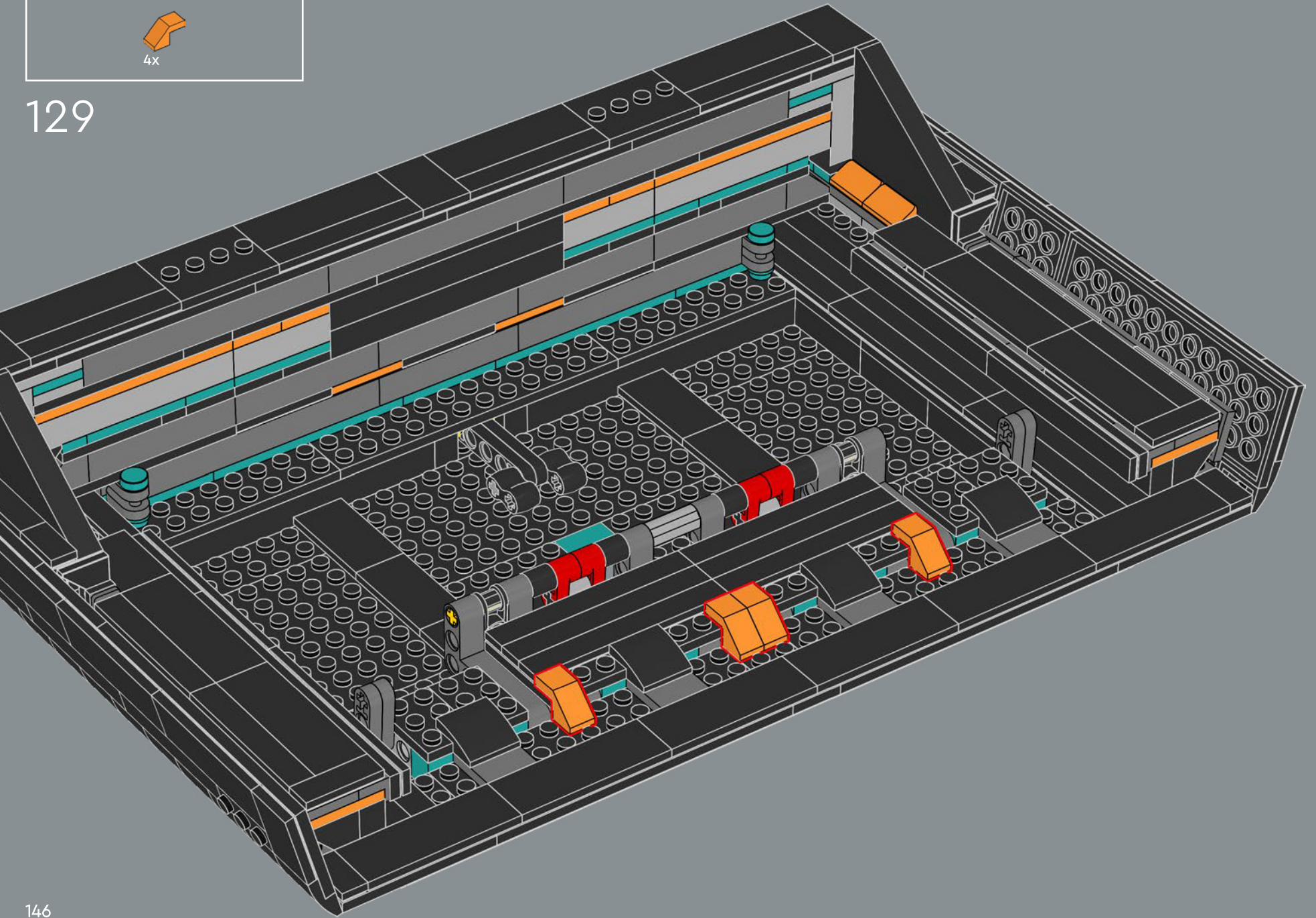

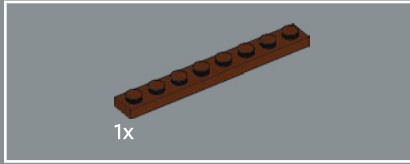
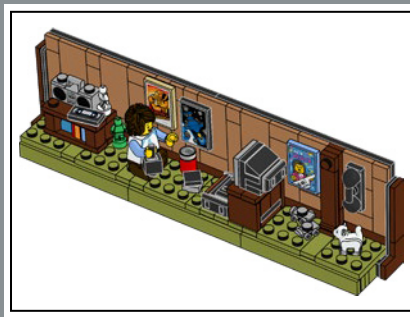

130

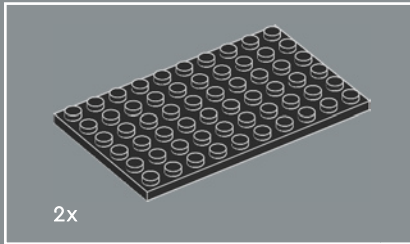
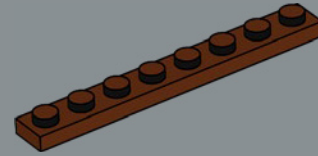

131

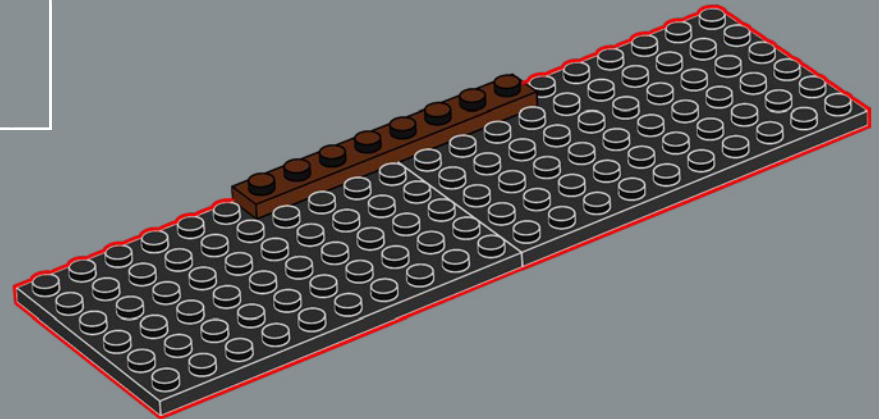

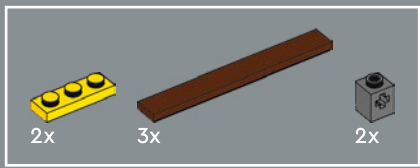

132

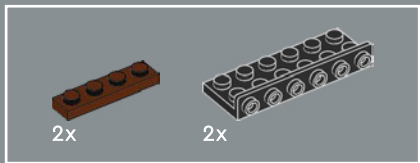
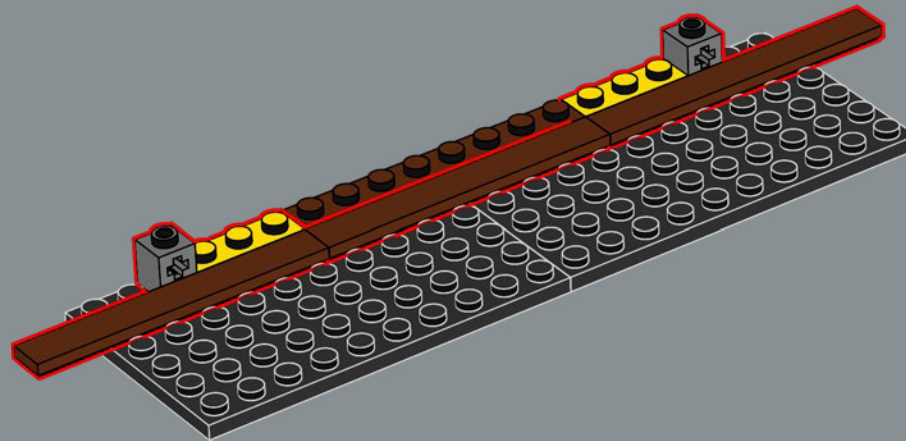

133

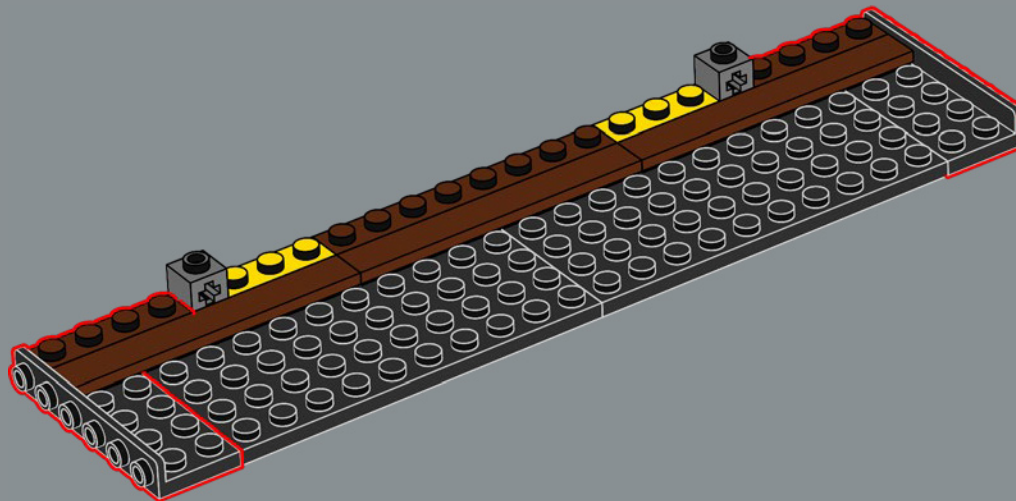

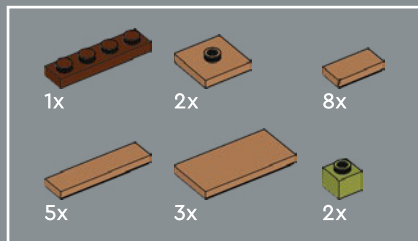

134

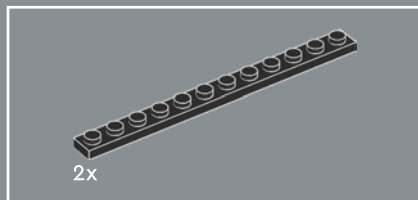
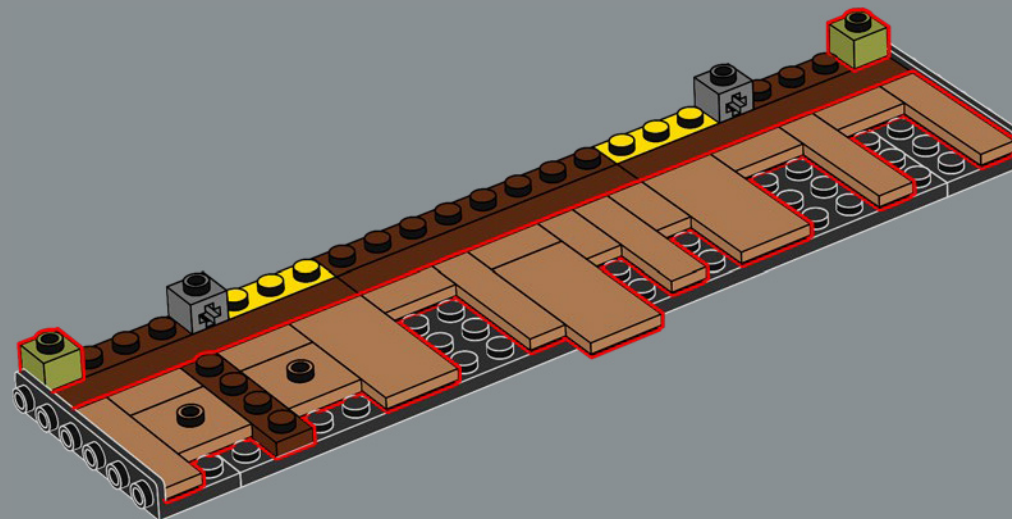

135

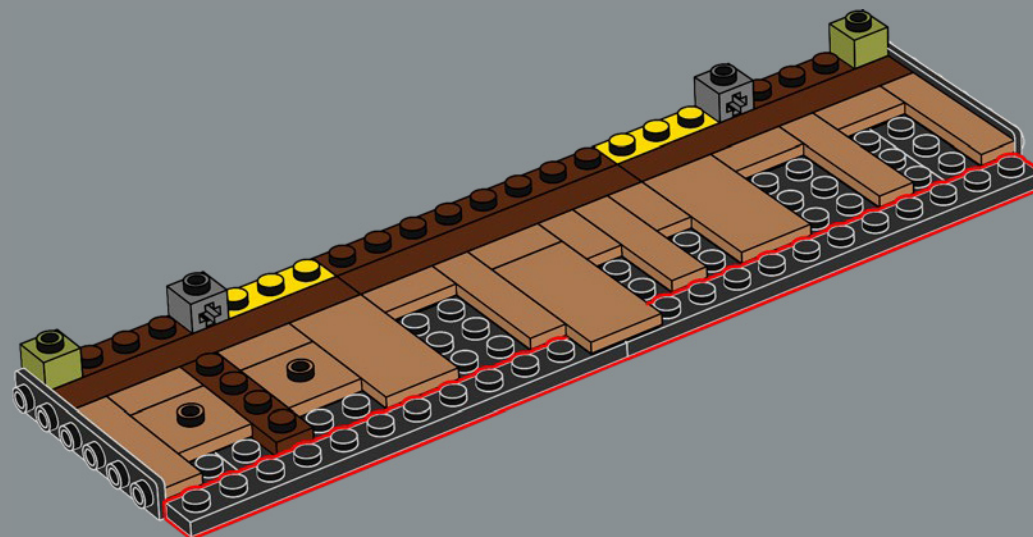

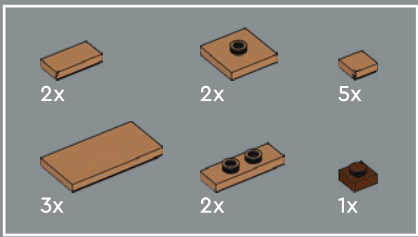

136

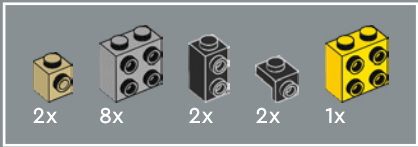
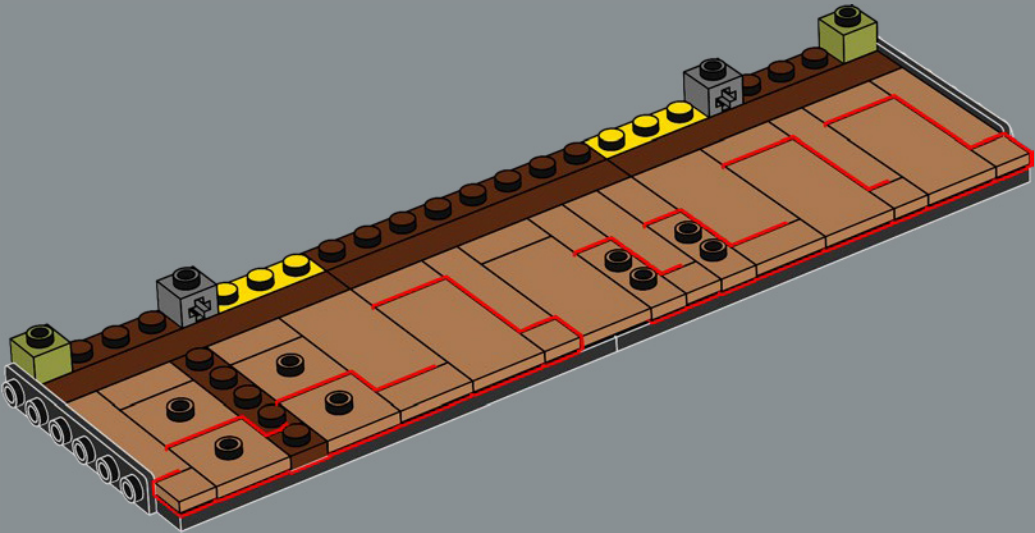

137

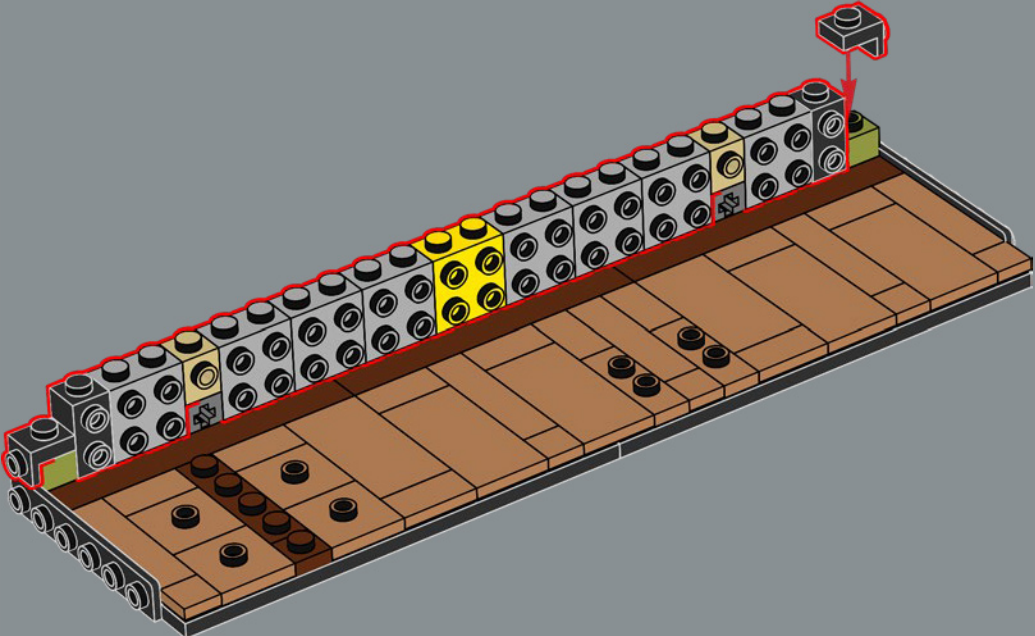

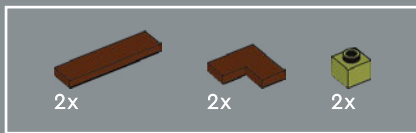

138

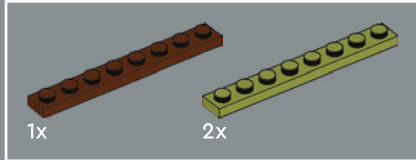
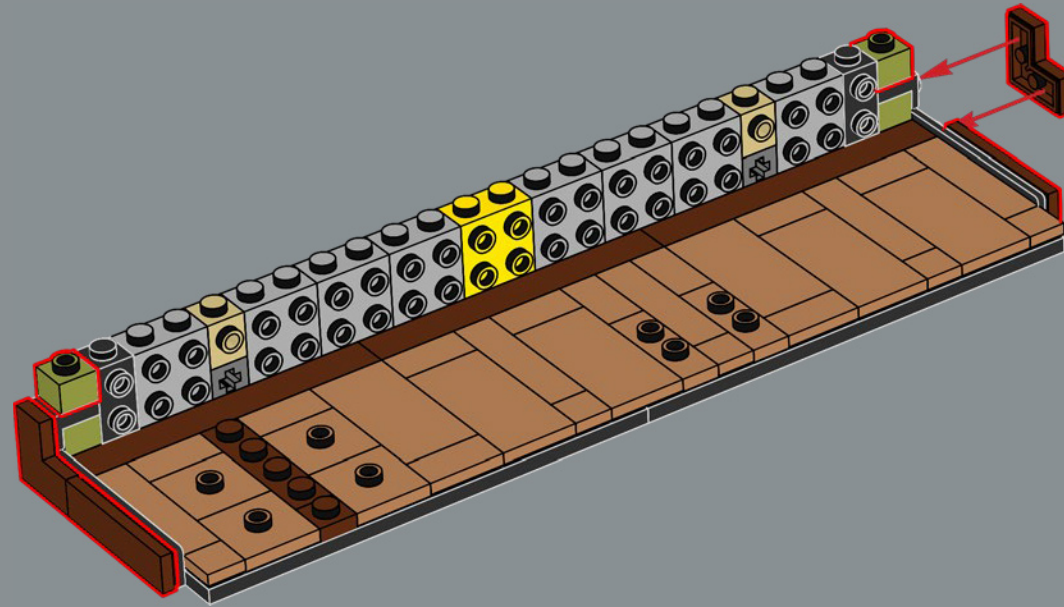

139

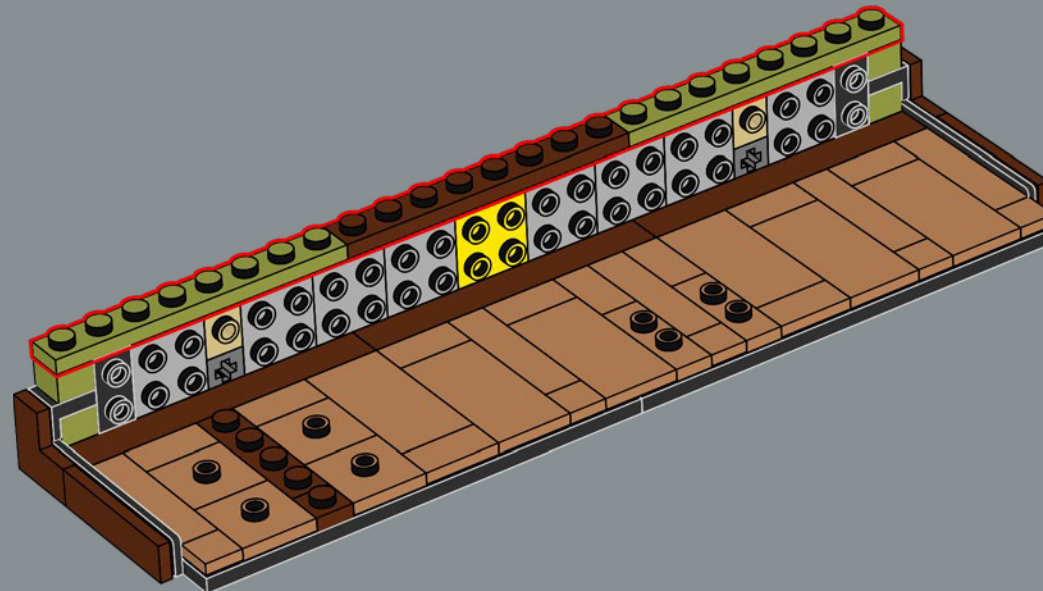

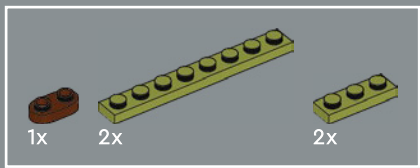

140

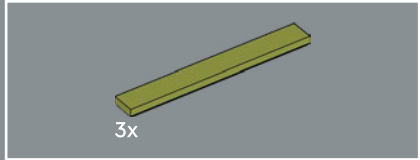
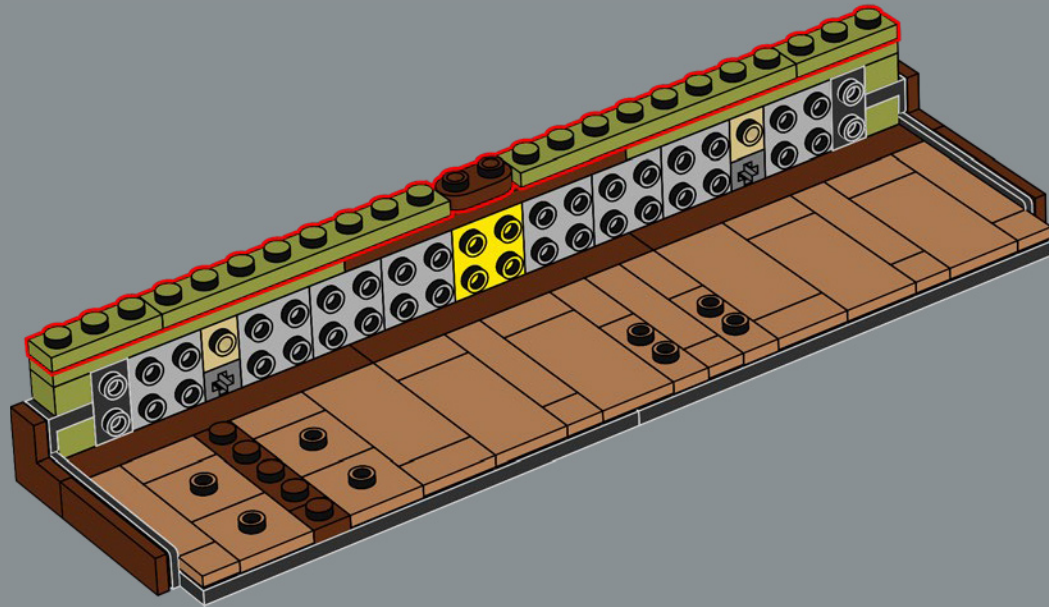

141

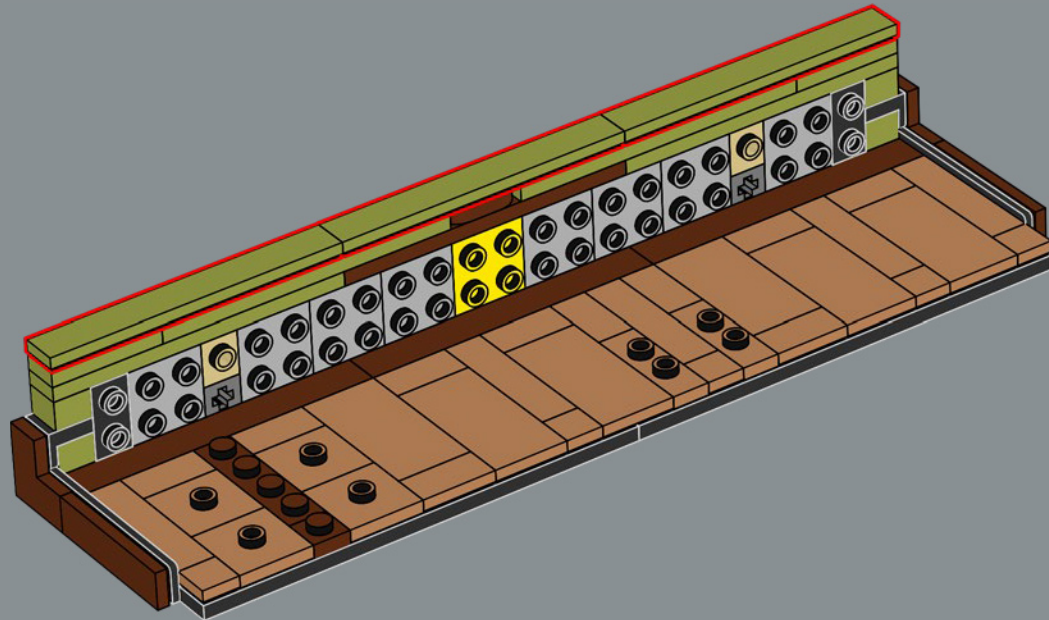

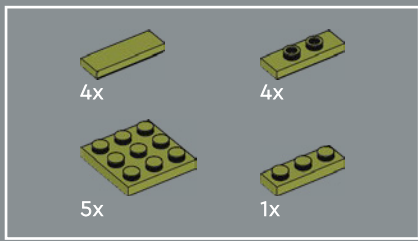

142

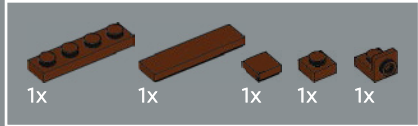
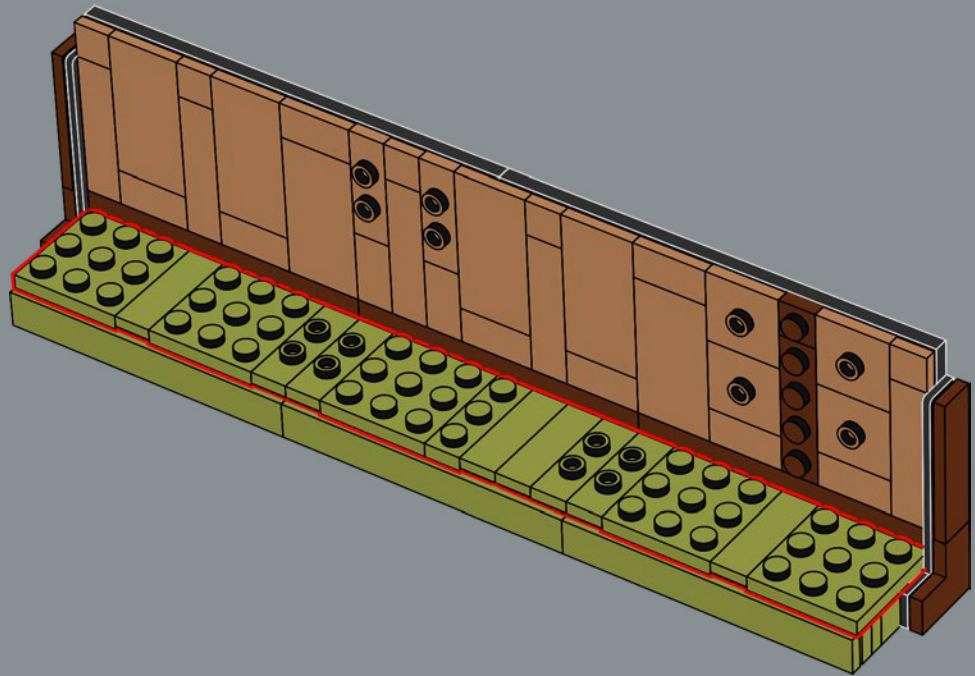

143

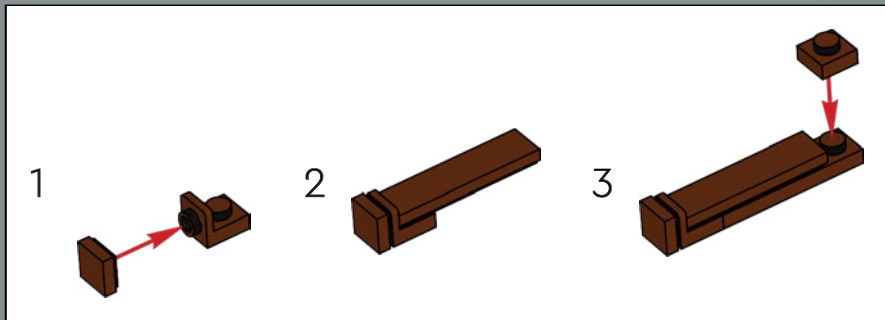
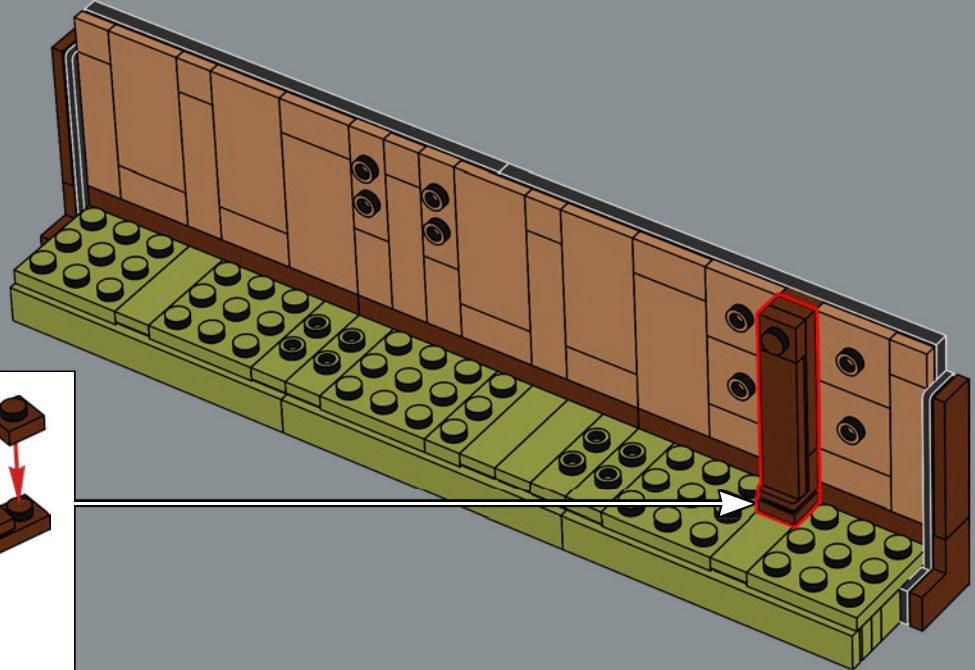

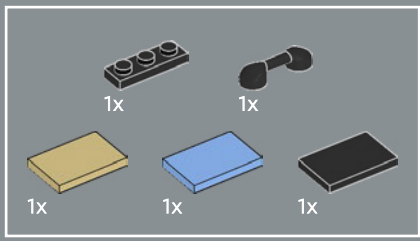

144

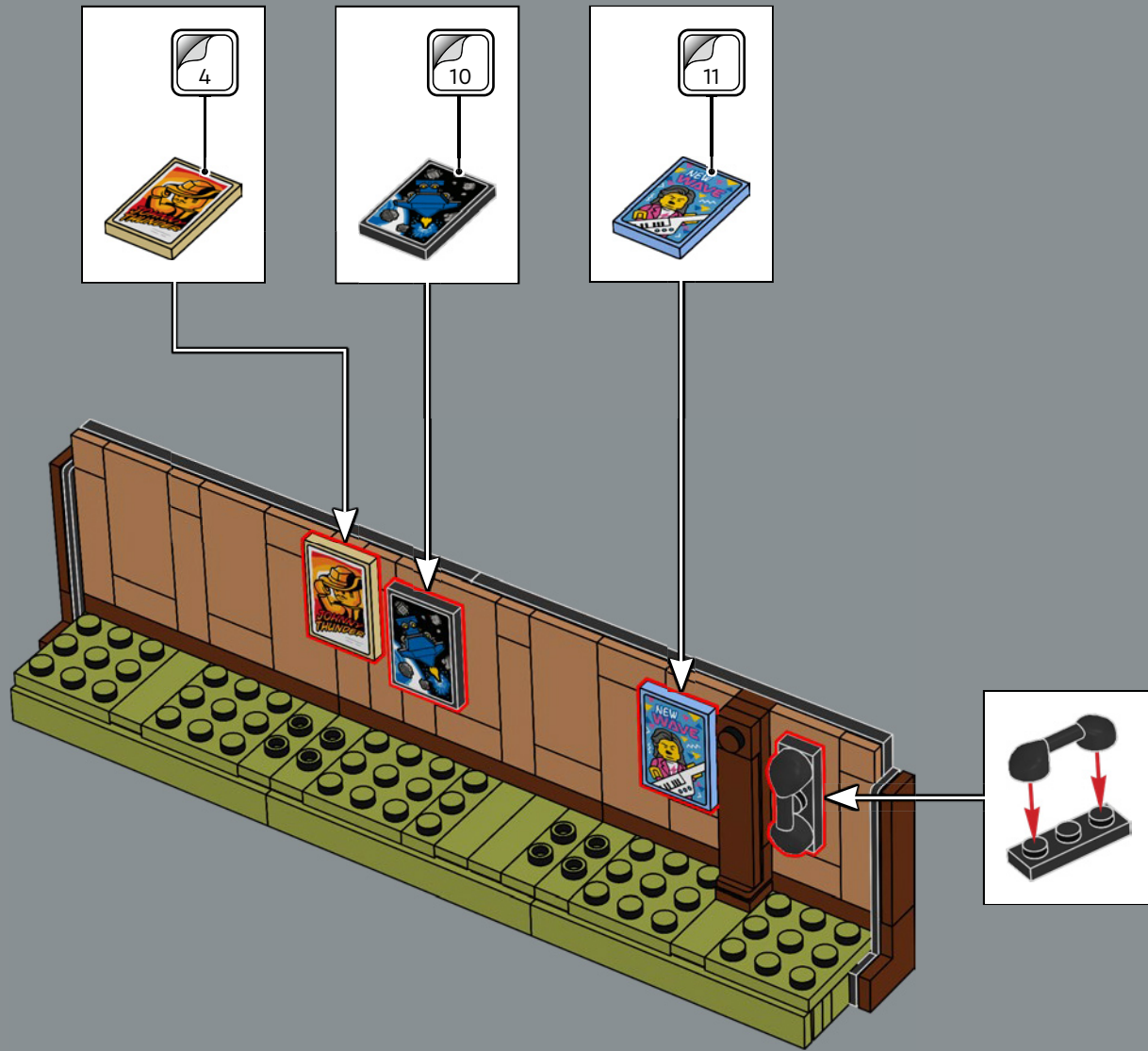

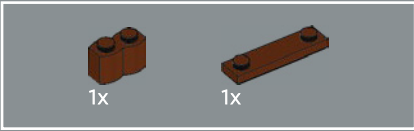

145

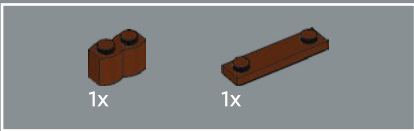
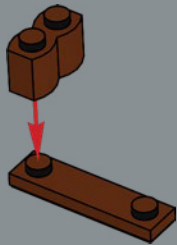

146

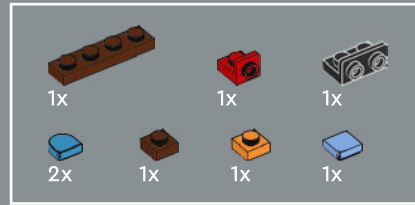
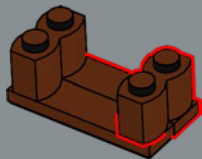

147

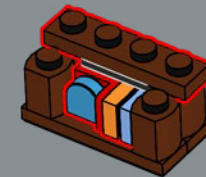
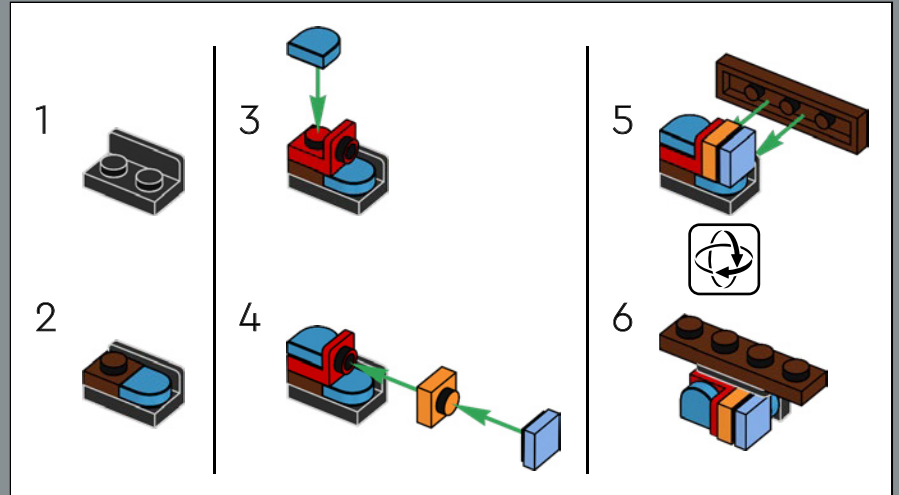

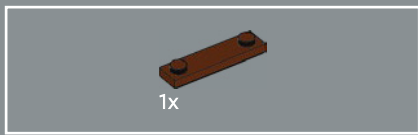

148

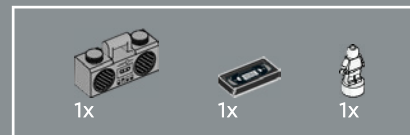
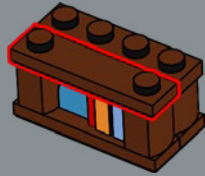

149



150

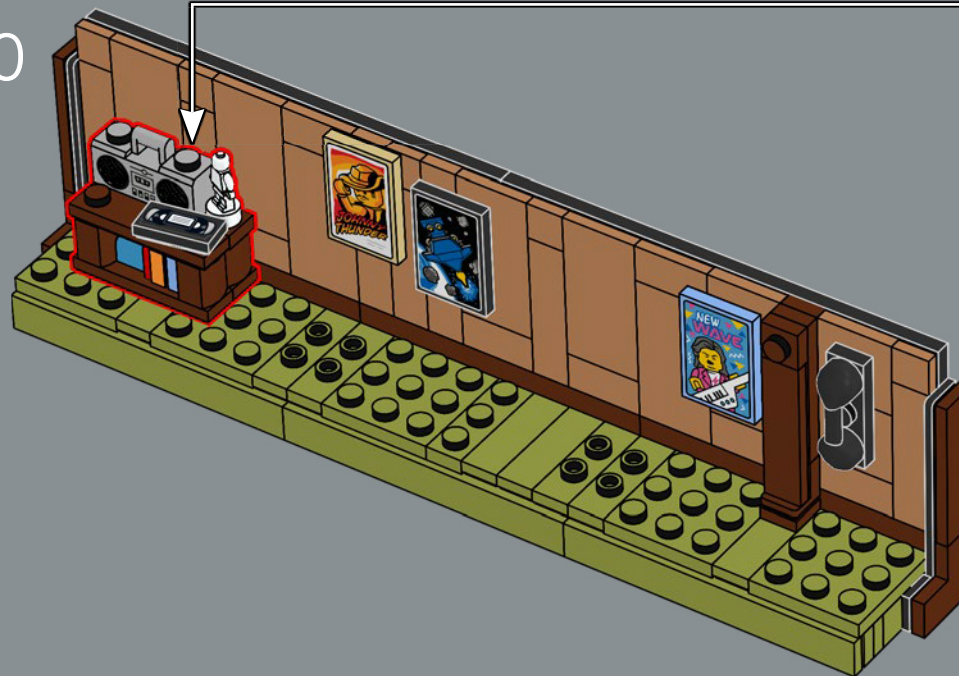

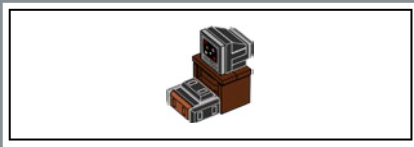

151

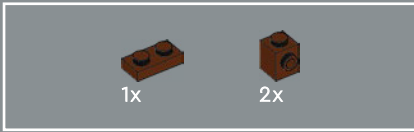
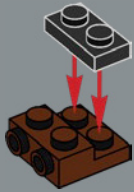

152

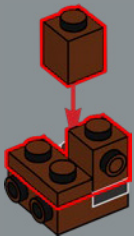

153

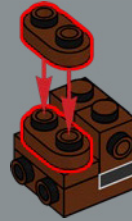

154

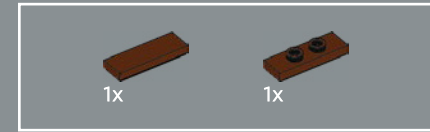
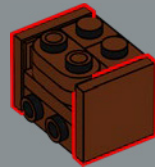

155

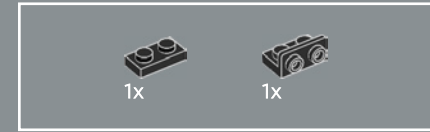
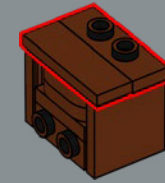

156

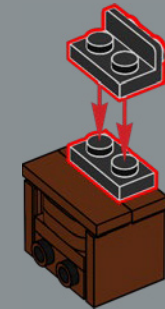



1x

157

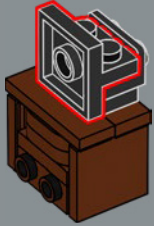

1x



1x



1x

158

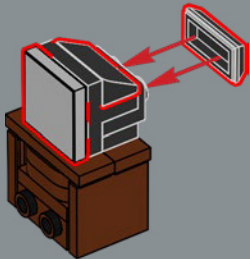

159



1x



3x



2x



1x

160

1

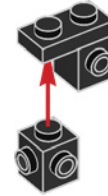

2



3

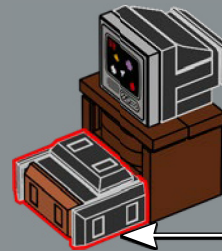

161

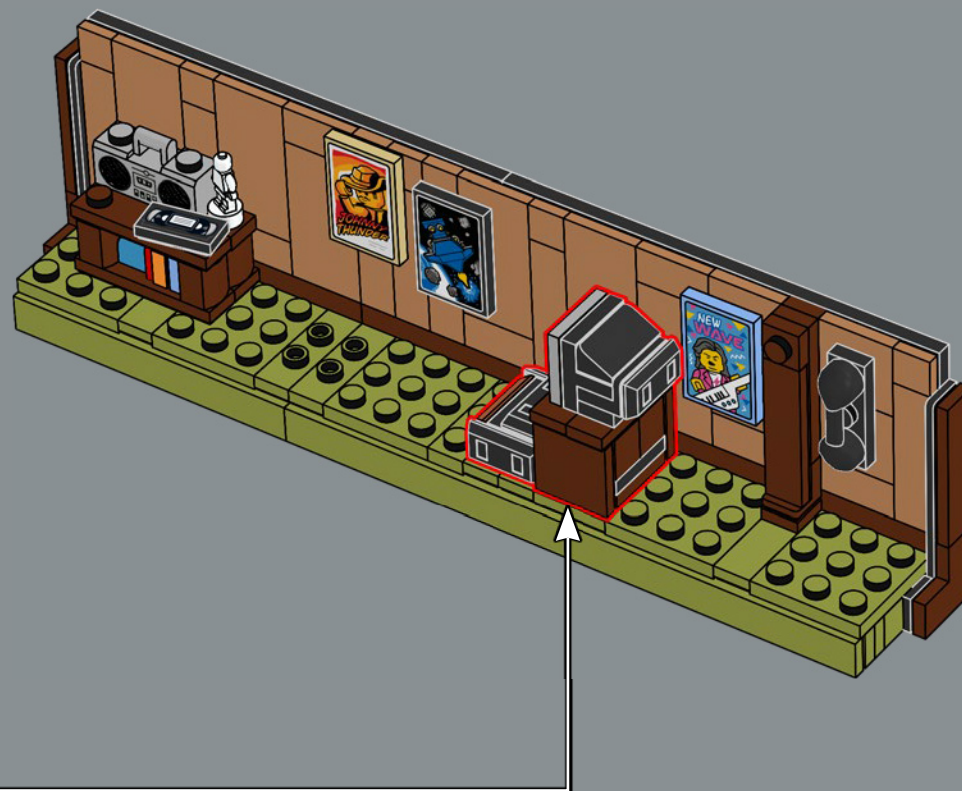



162

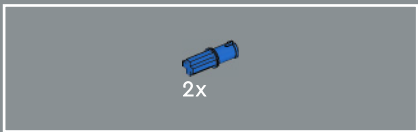

163

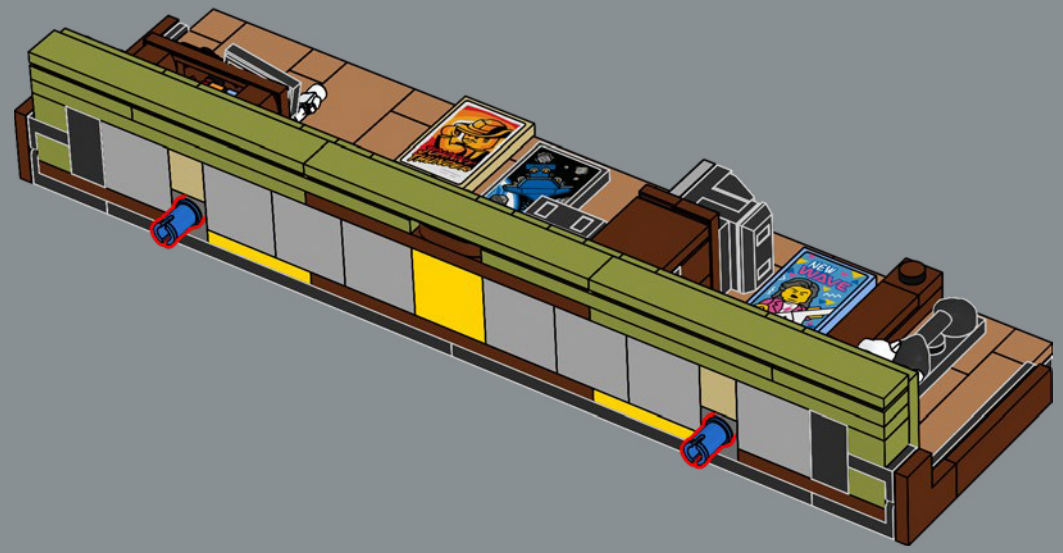

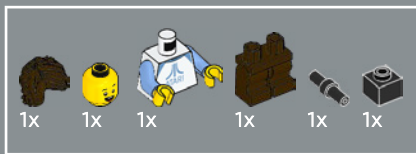

164

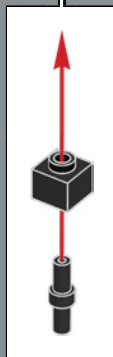
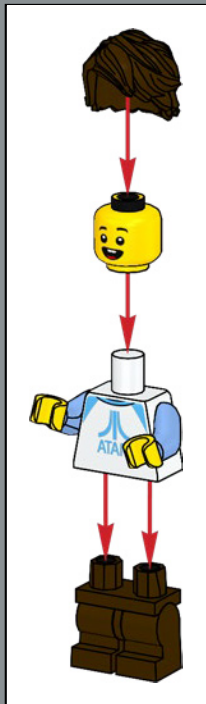

165

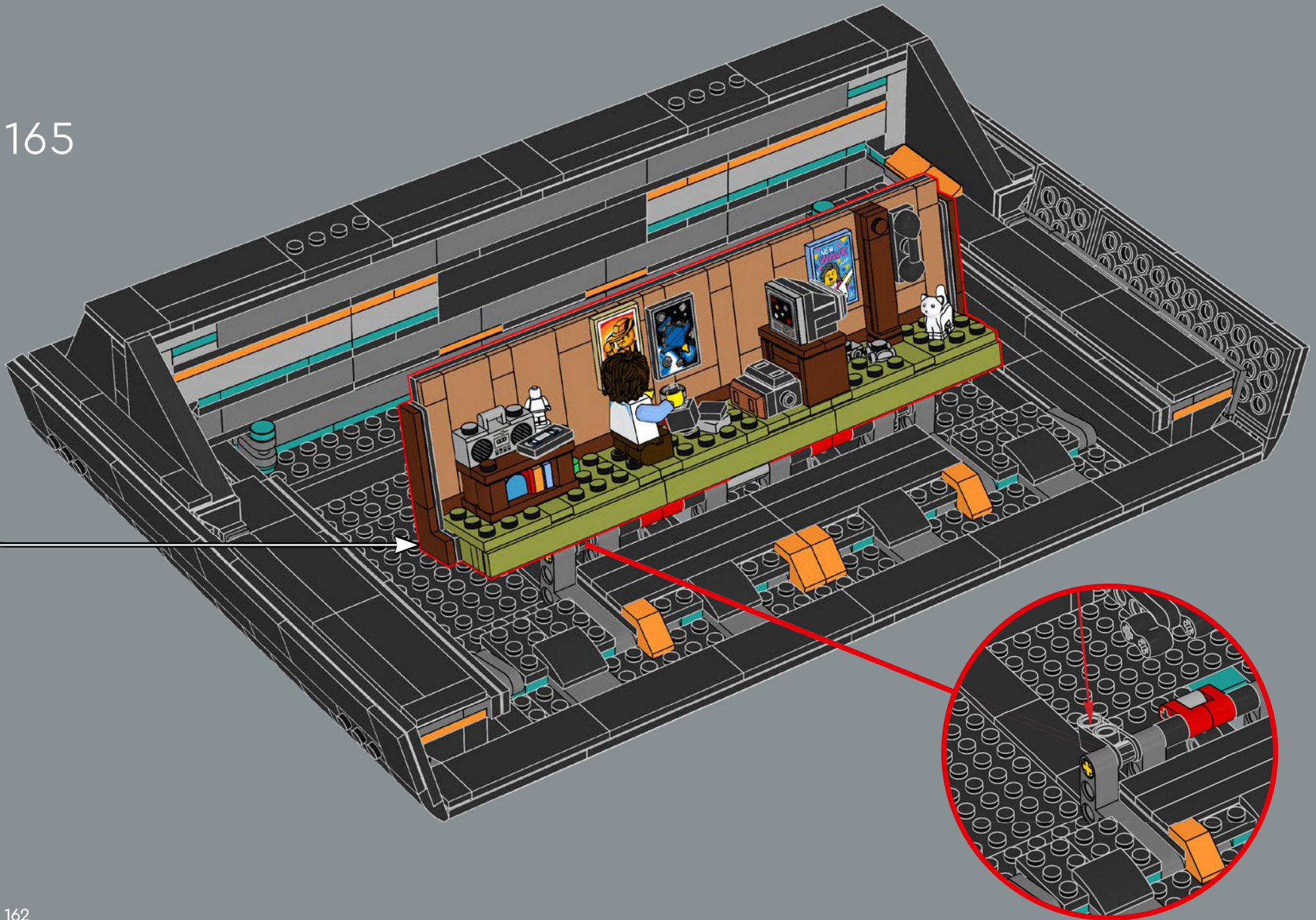

162

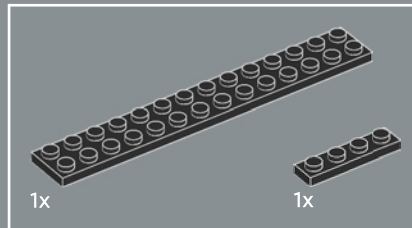
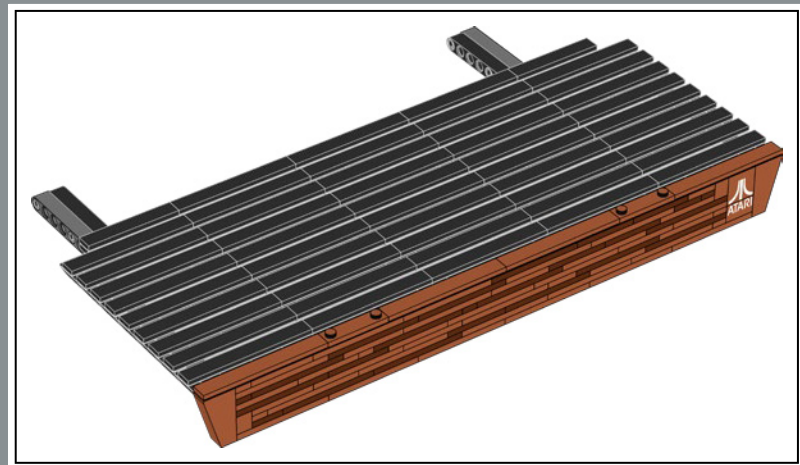
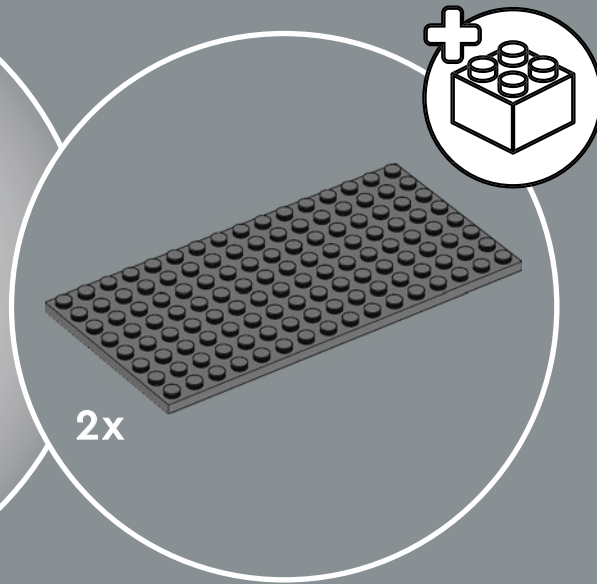

166

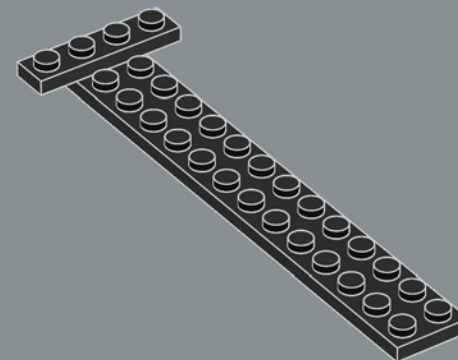

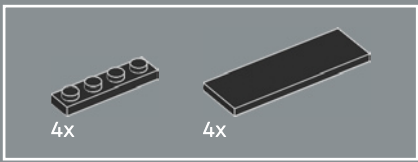

167

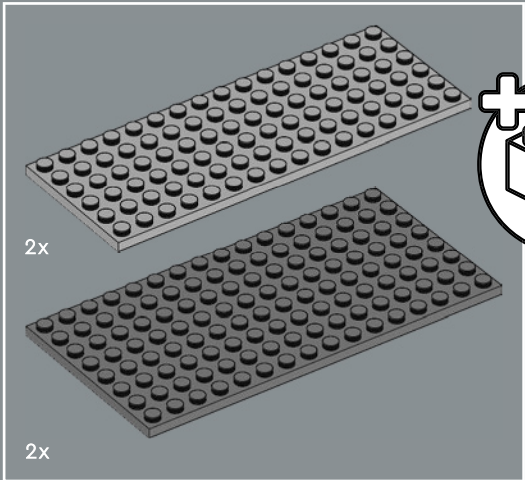
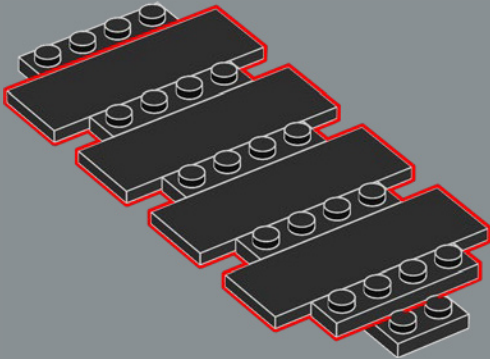

168

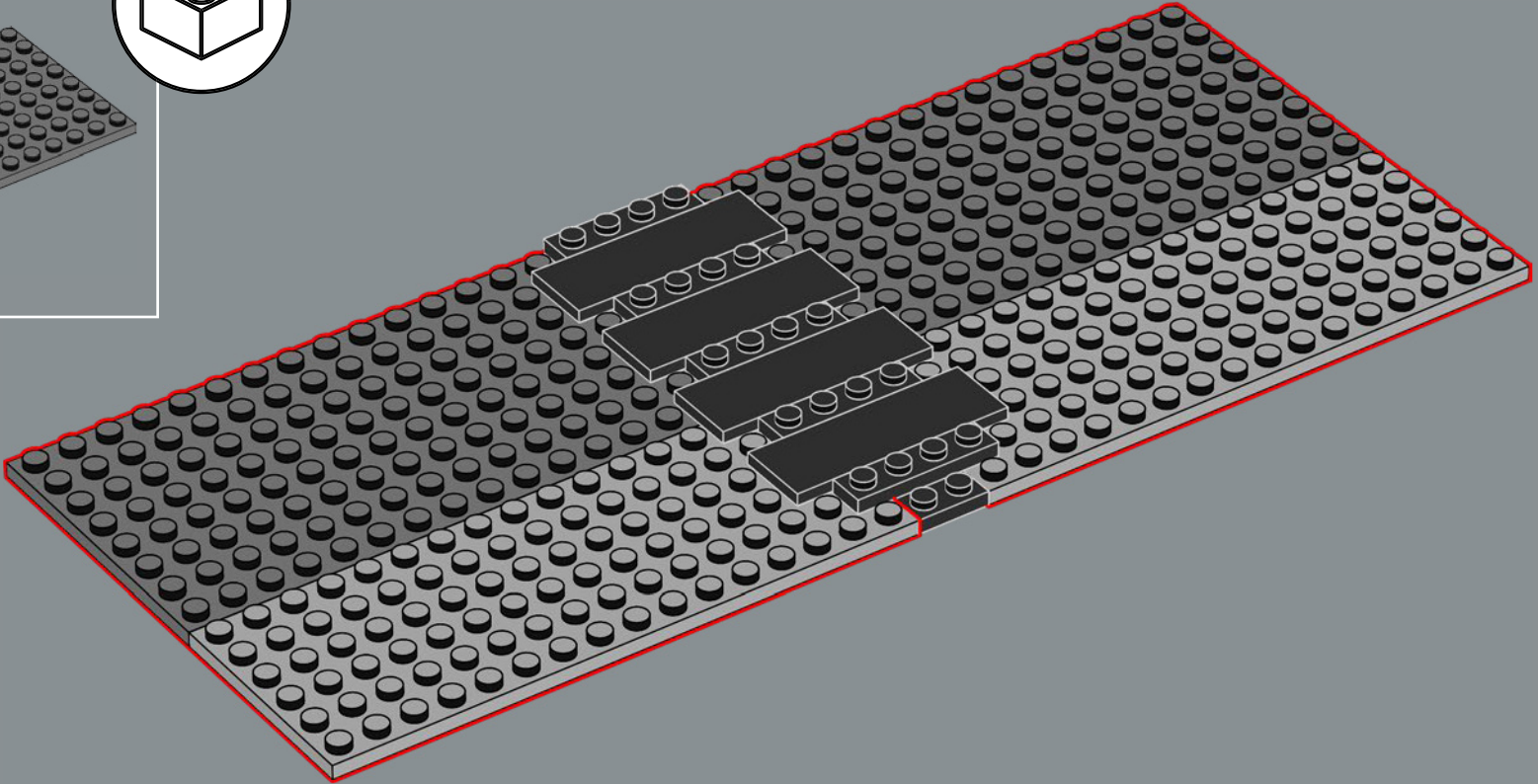

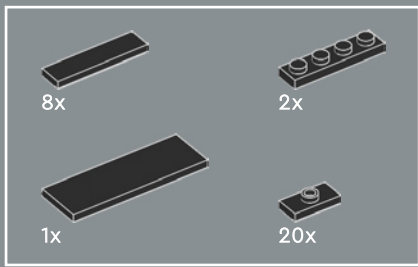

169

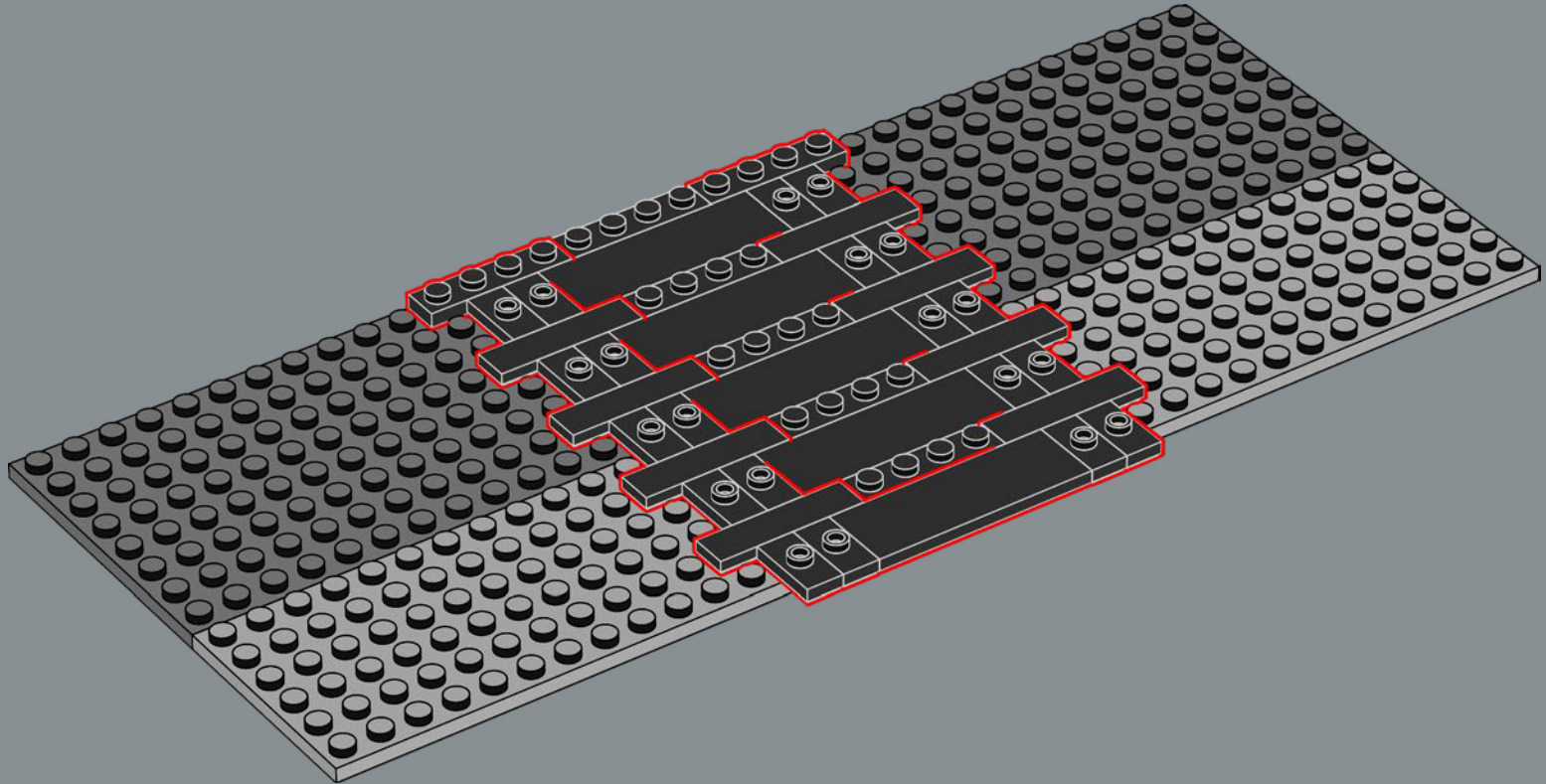

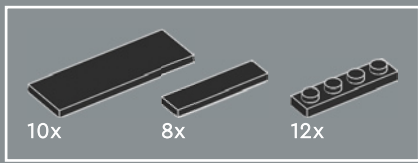

170

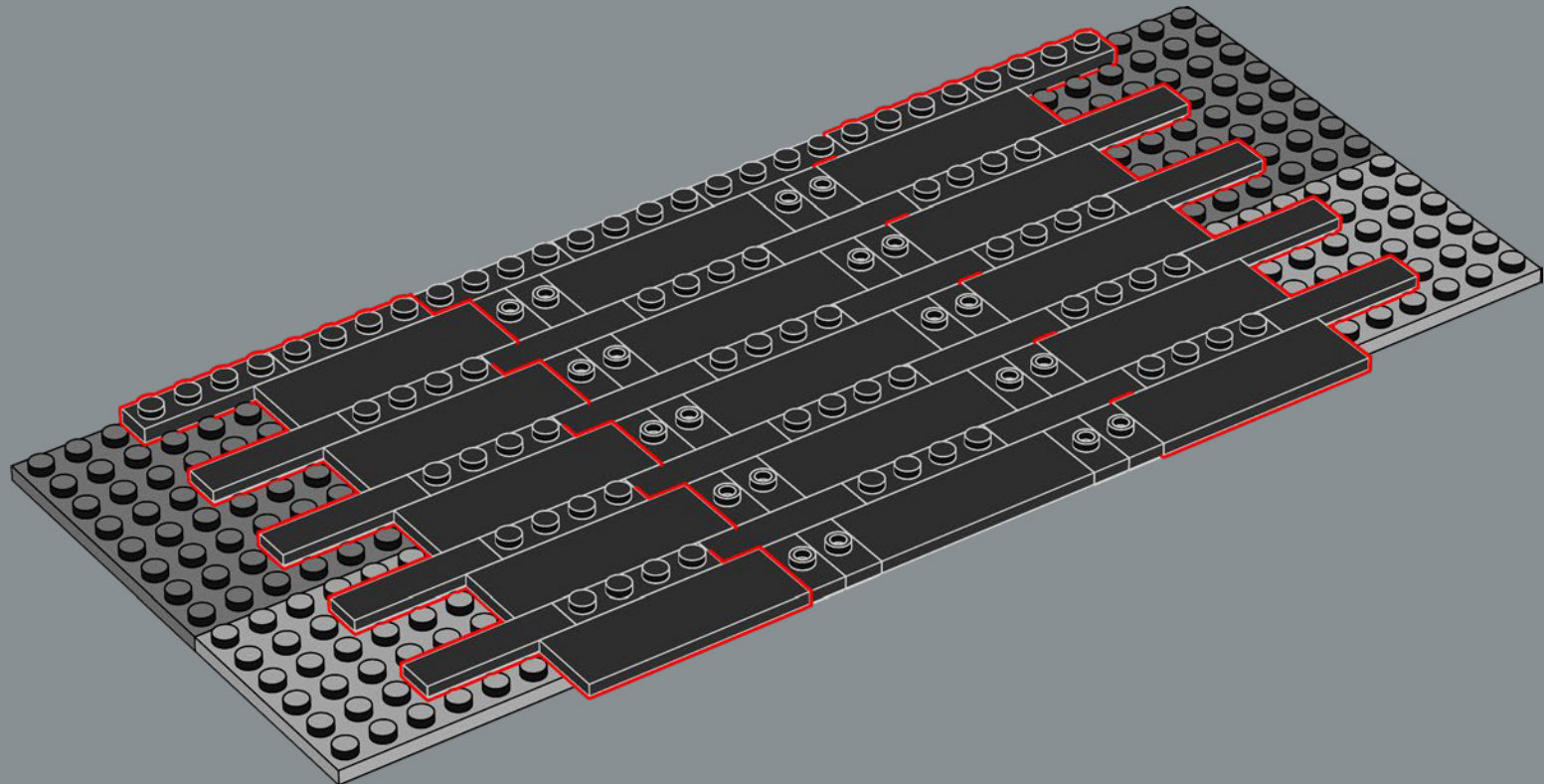



171

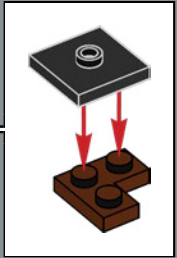
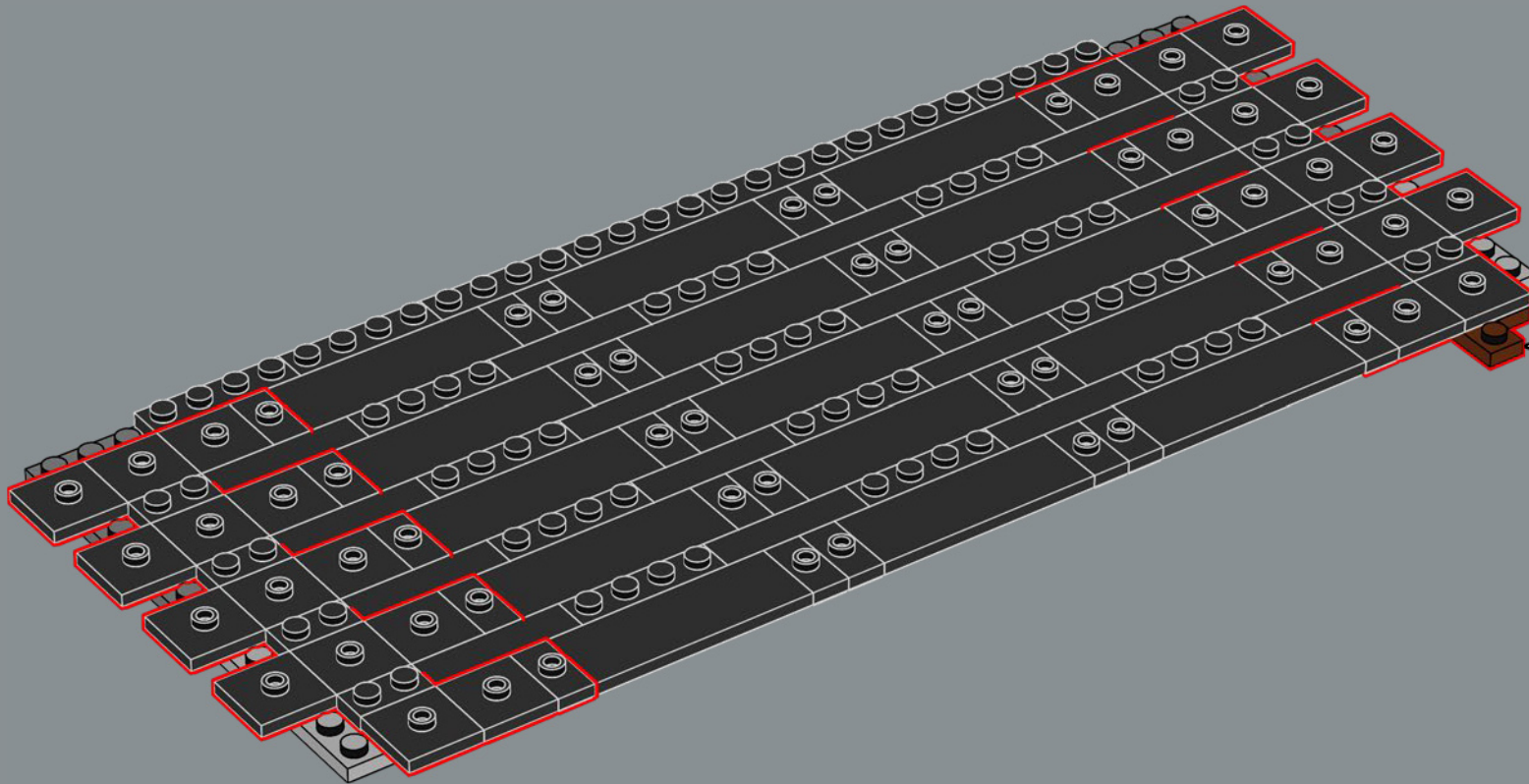

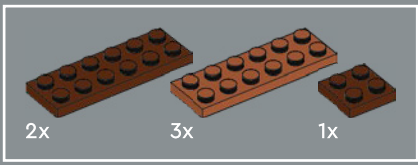

172

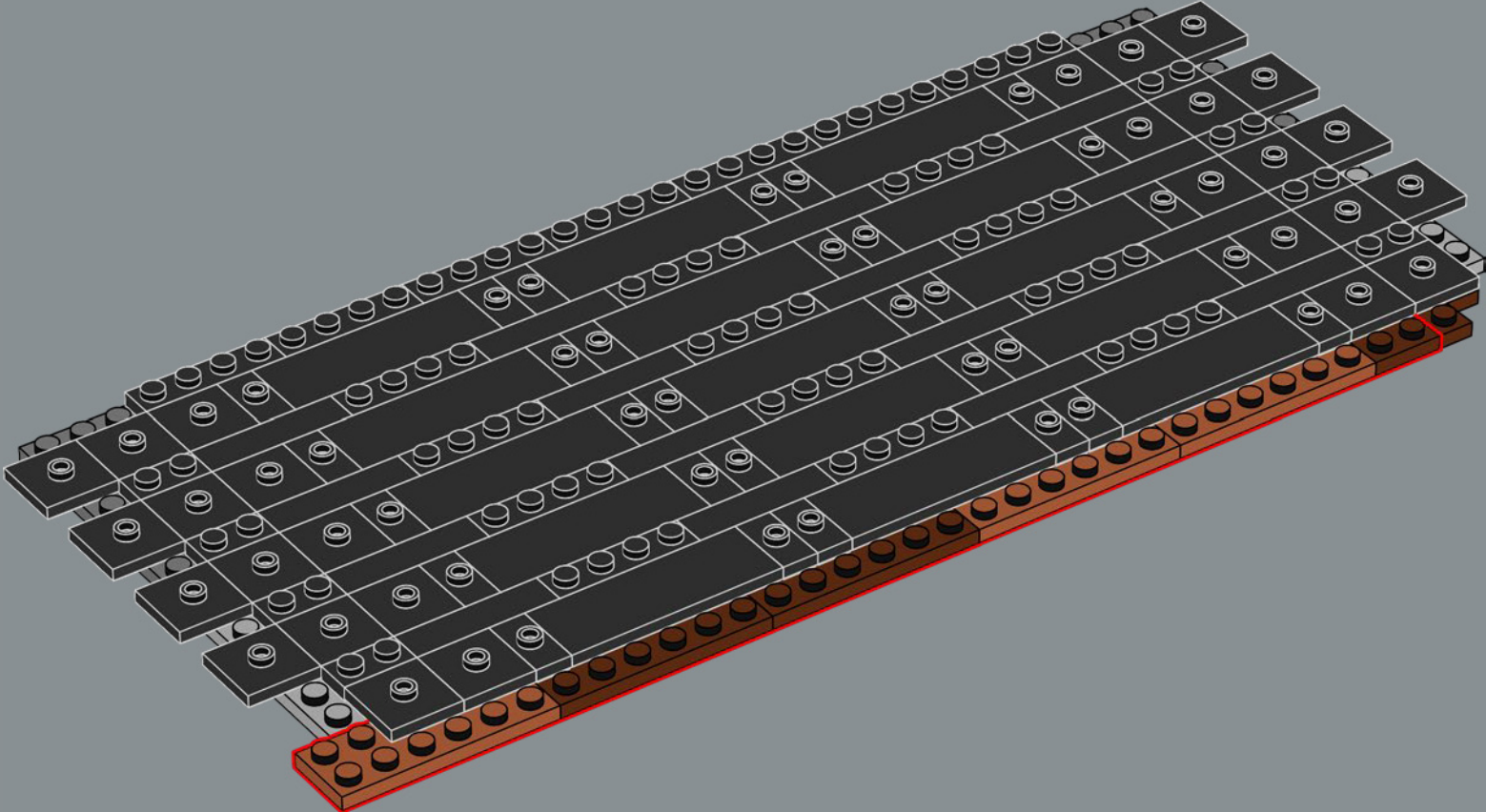

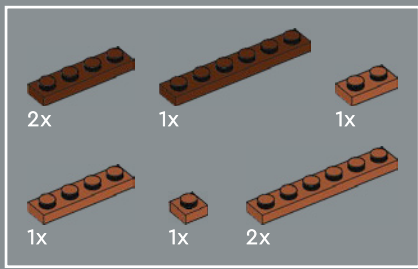

173

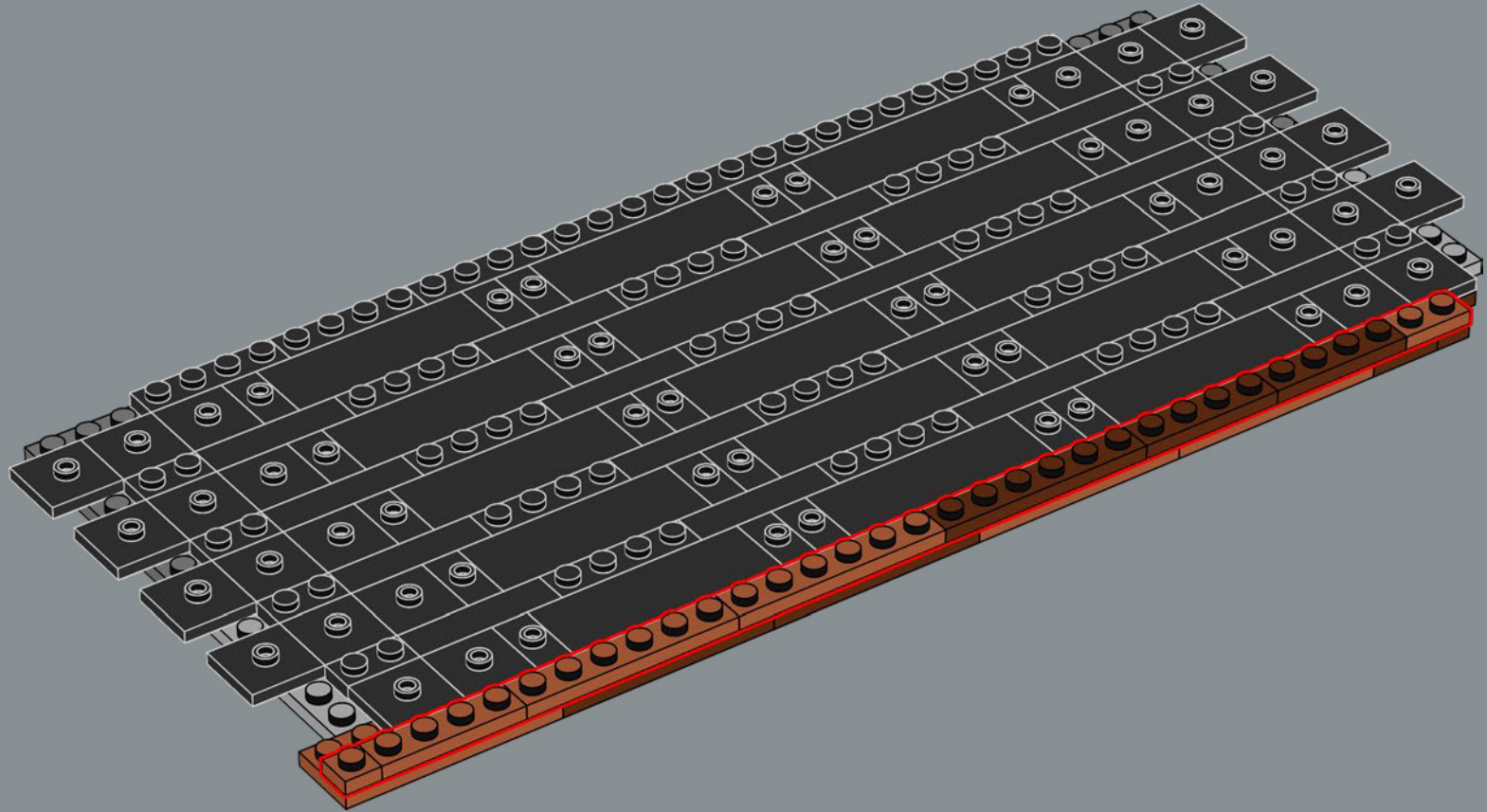

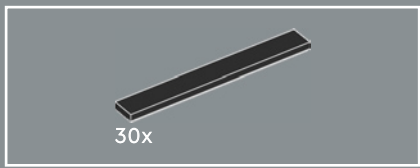

174

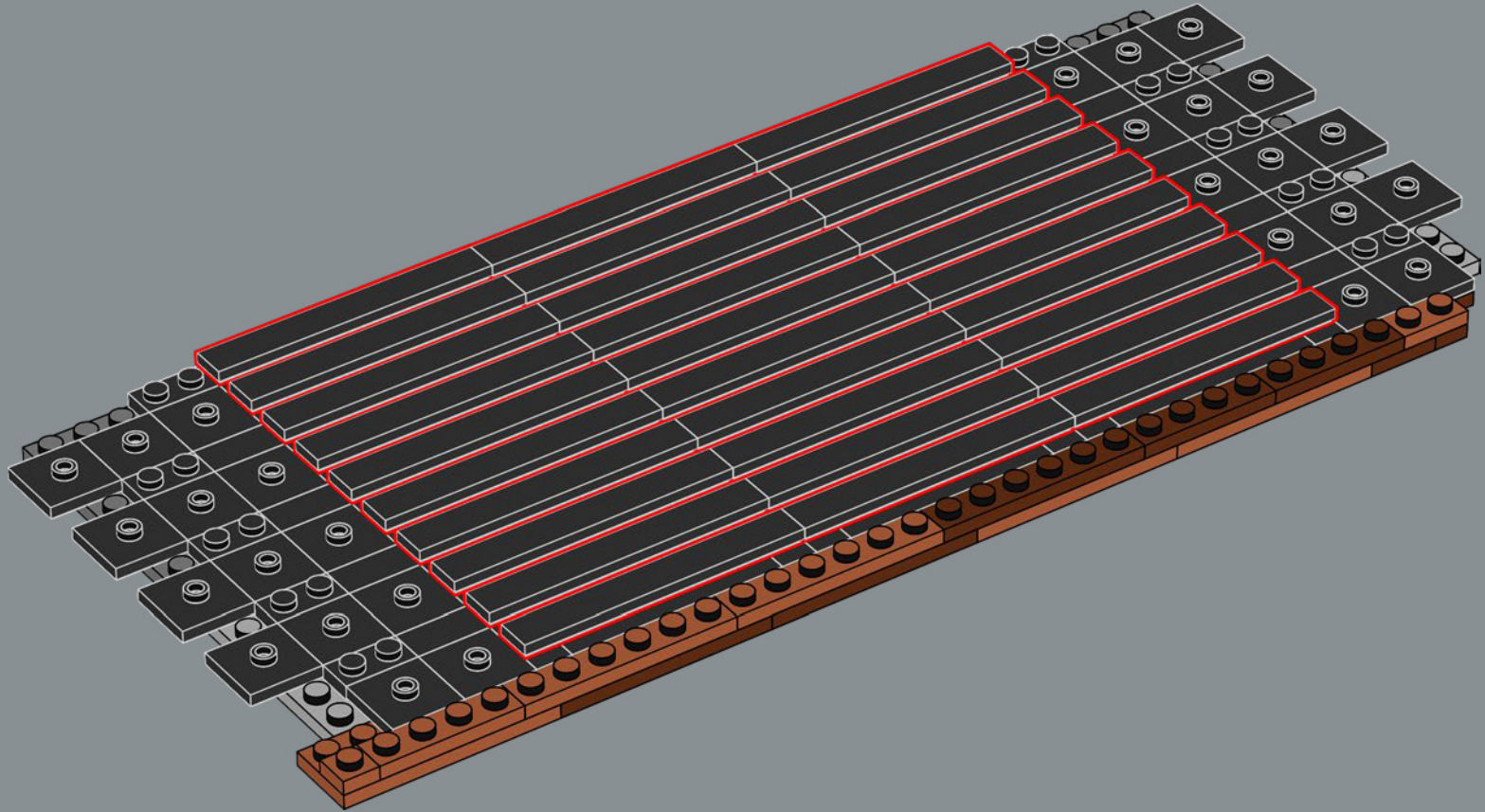

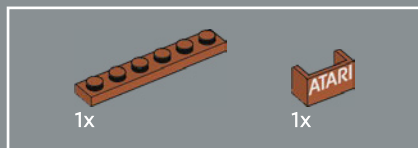
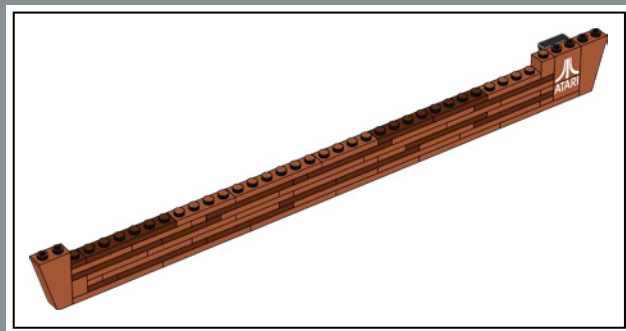

175

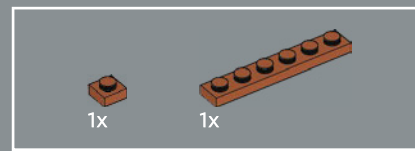
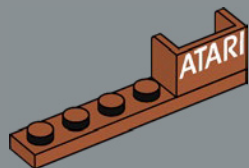

176

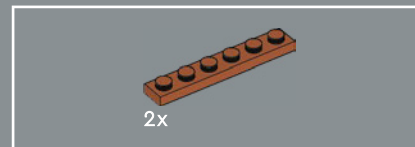
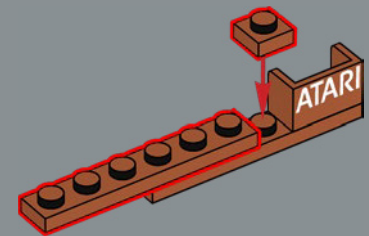

177

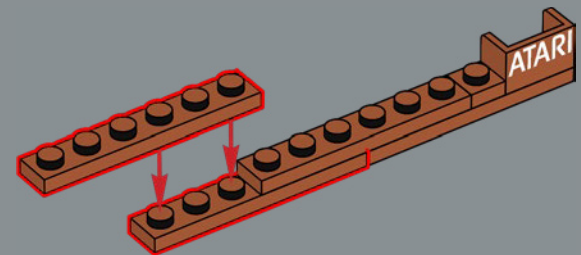

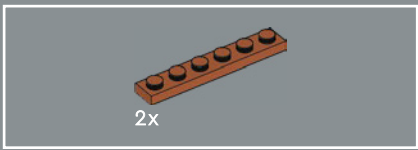

178

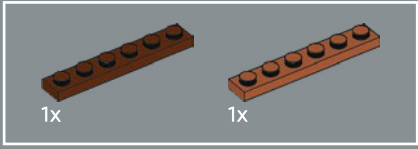
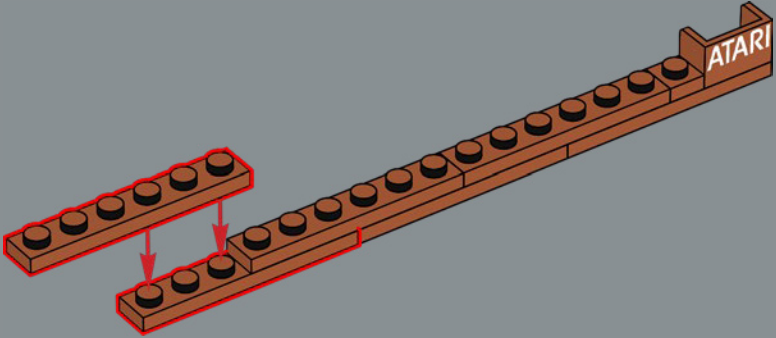

179

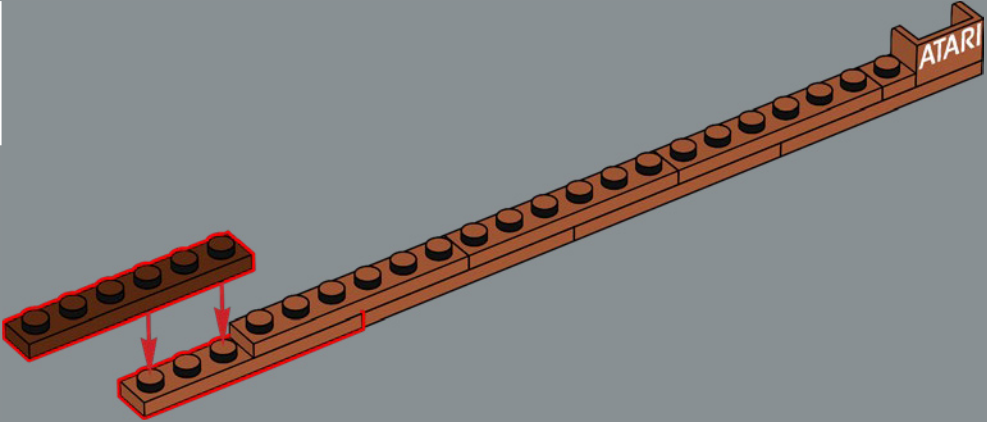

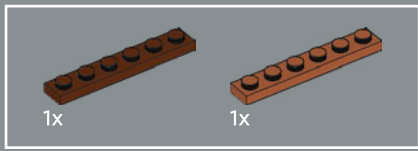

180

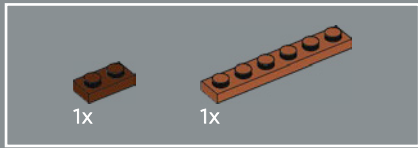
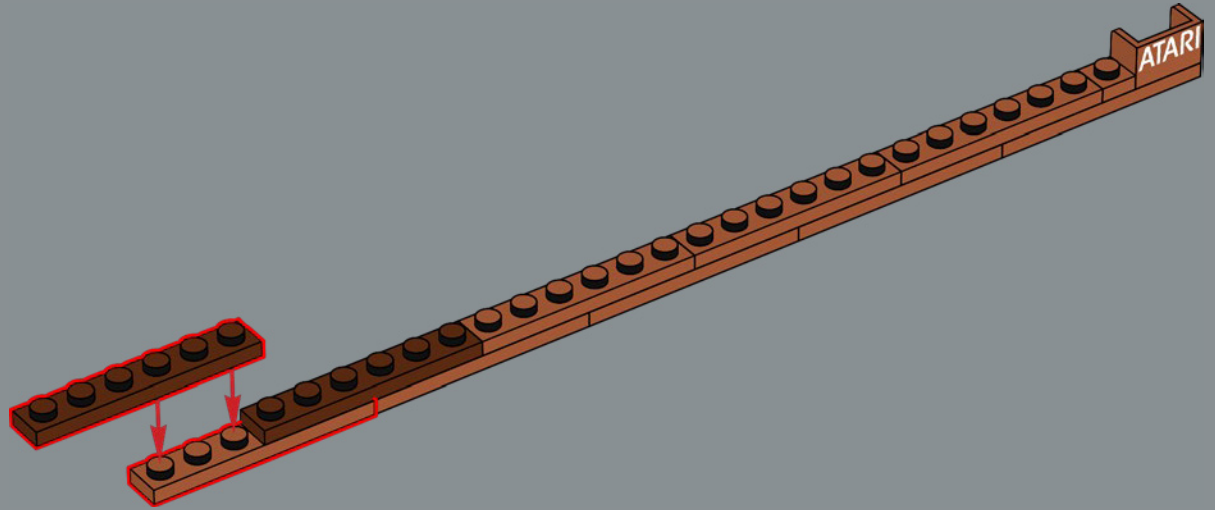

181

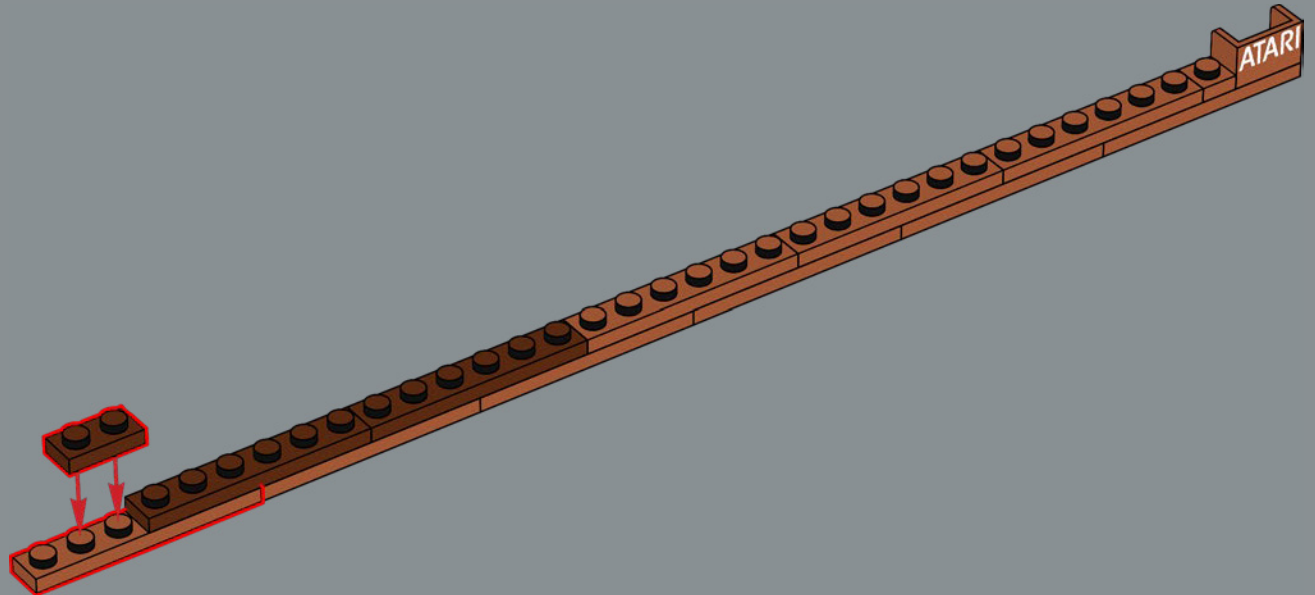

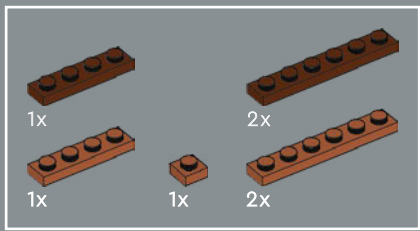

182

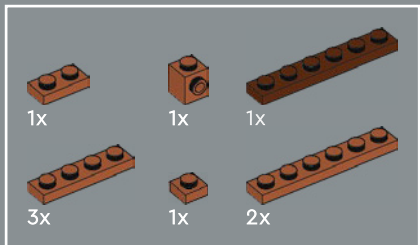
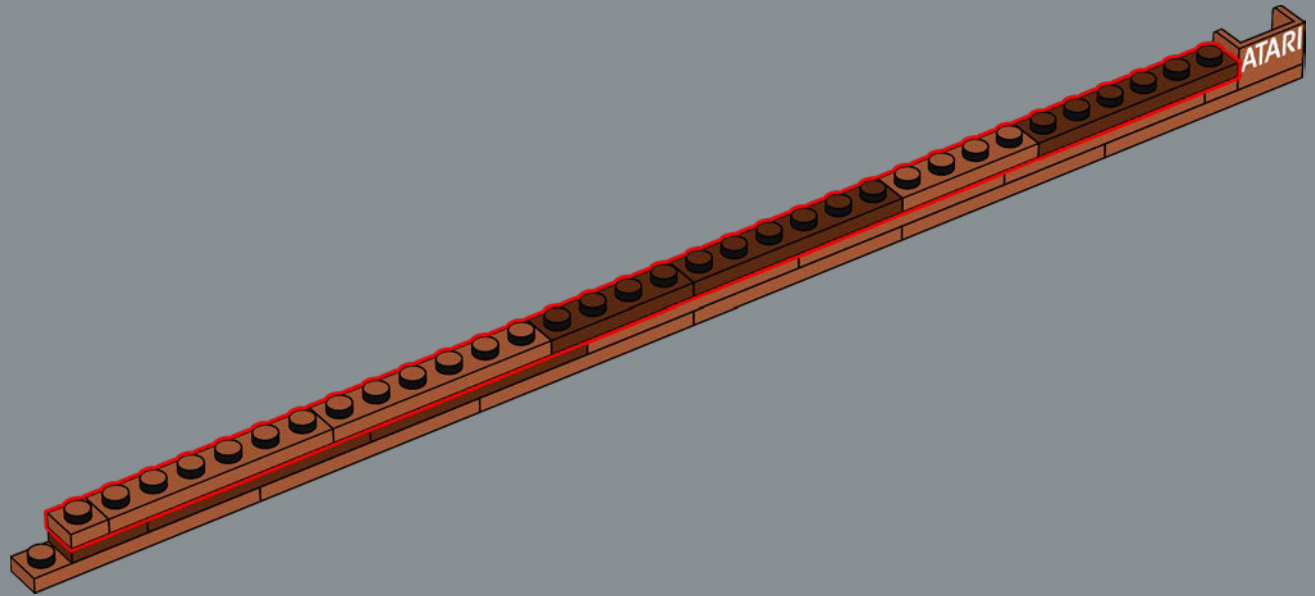

183

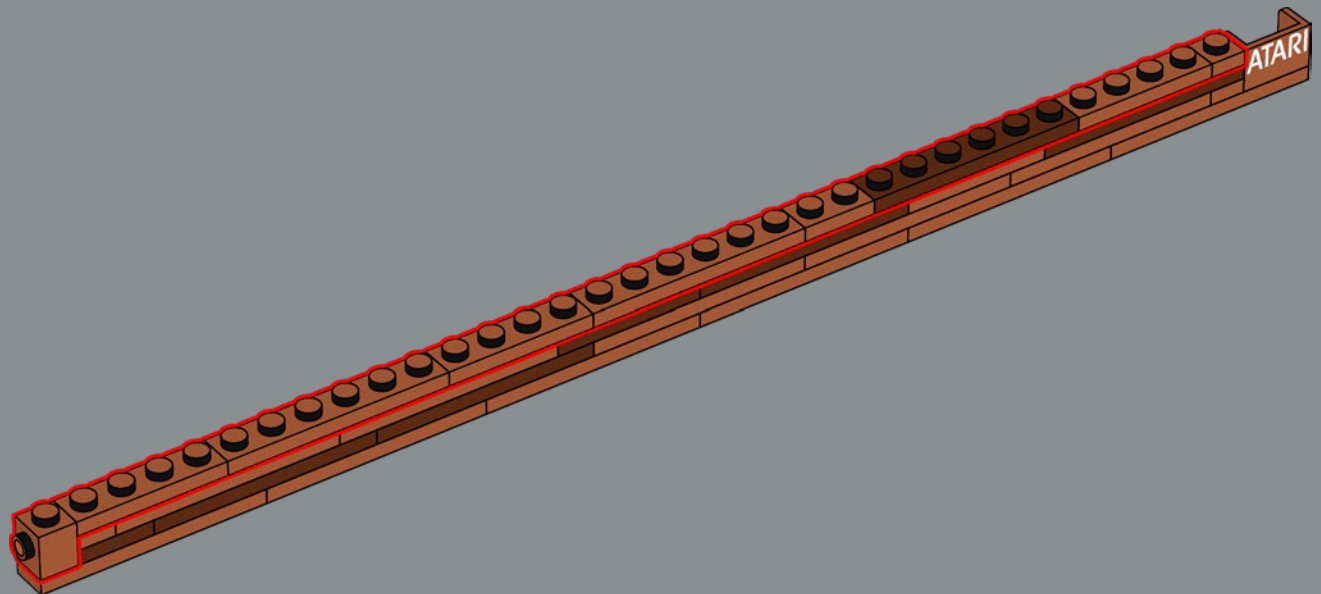

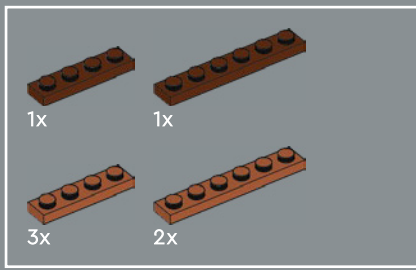

184

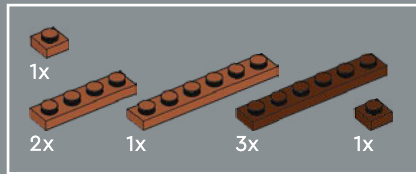
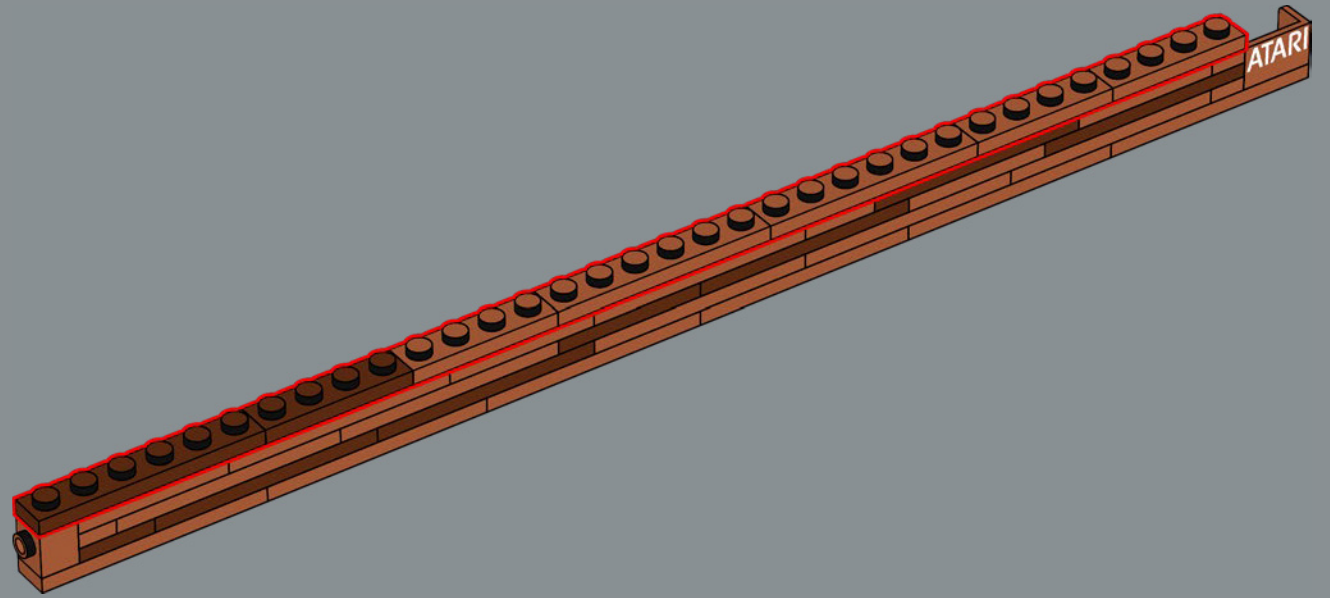

185

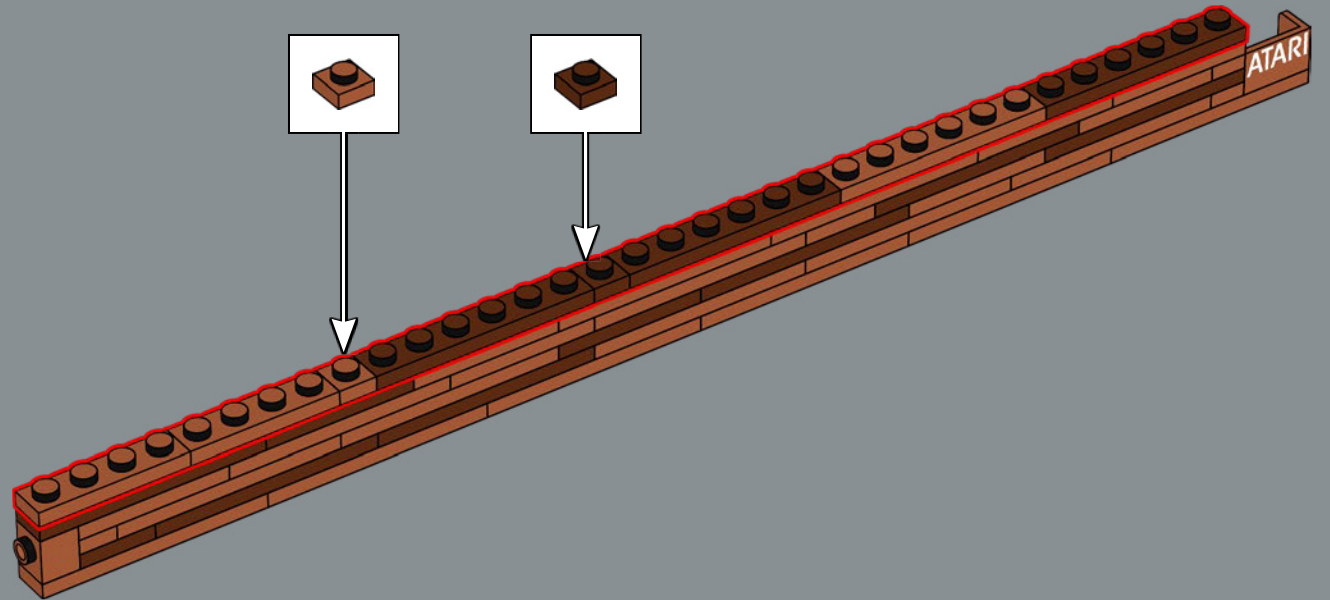



186

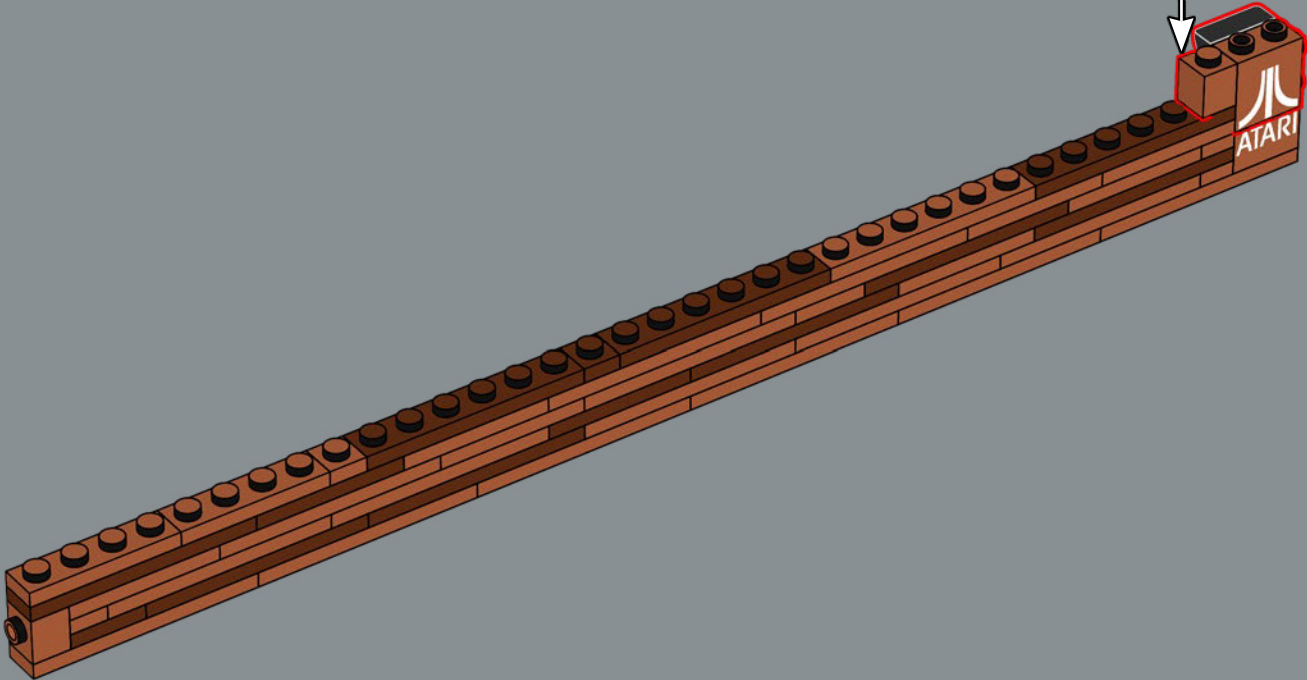
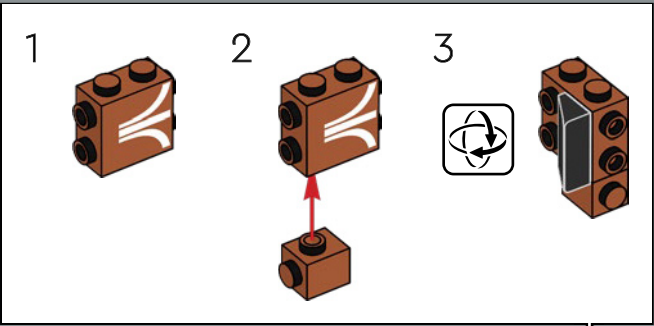

雅达利于 1972 年 6 月 27 日
注册成立。



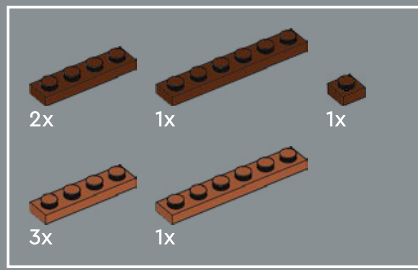

187

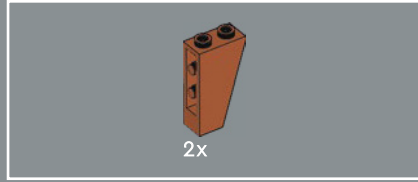
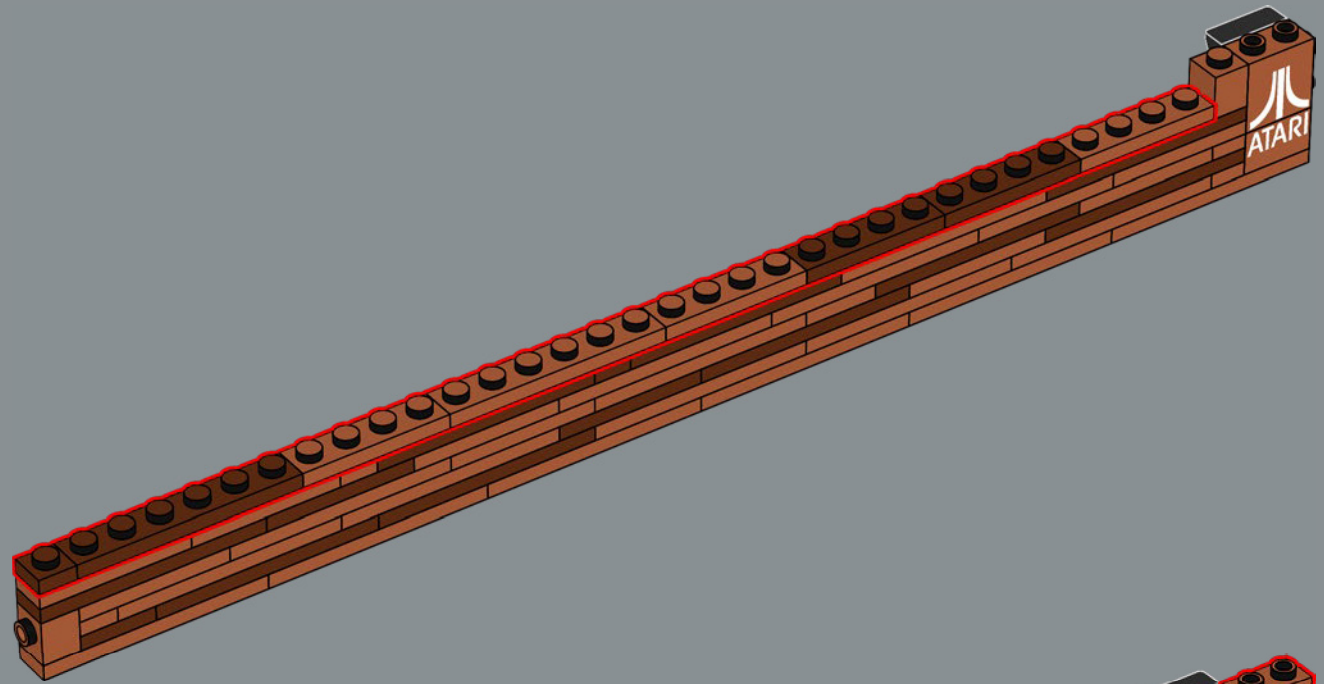

188

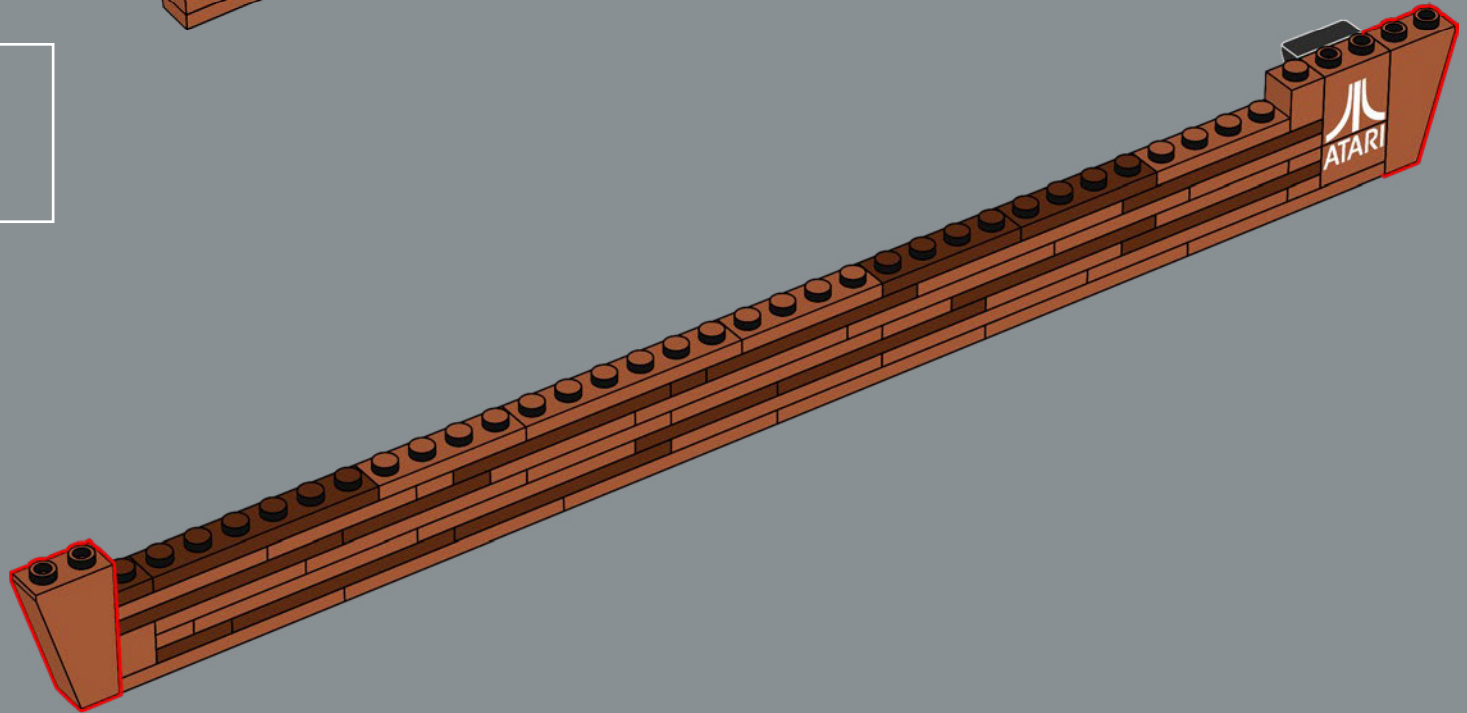

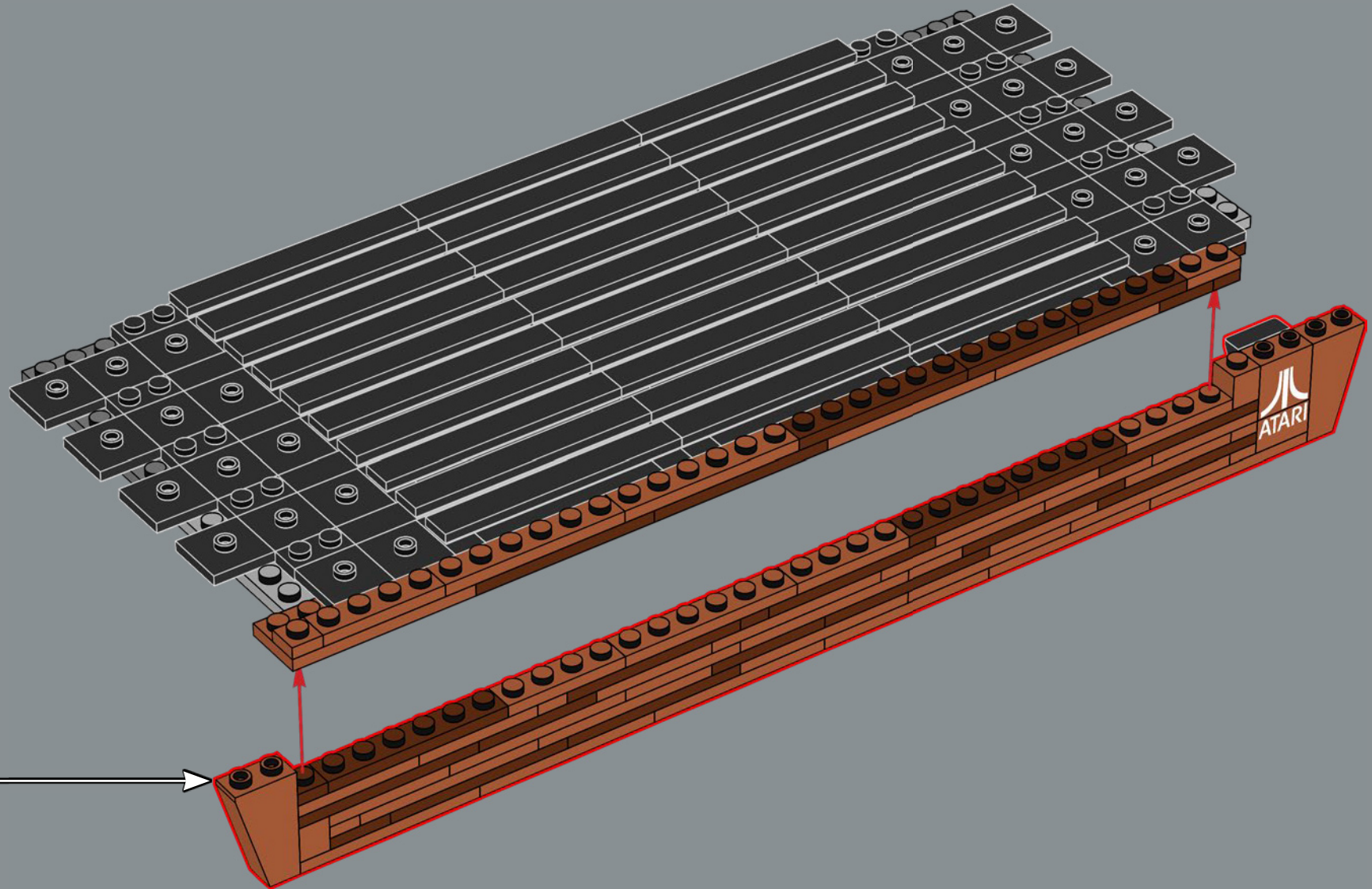

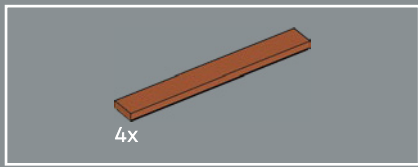

190

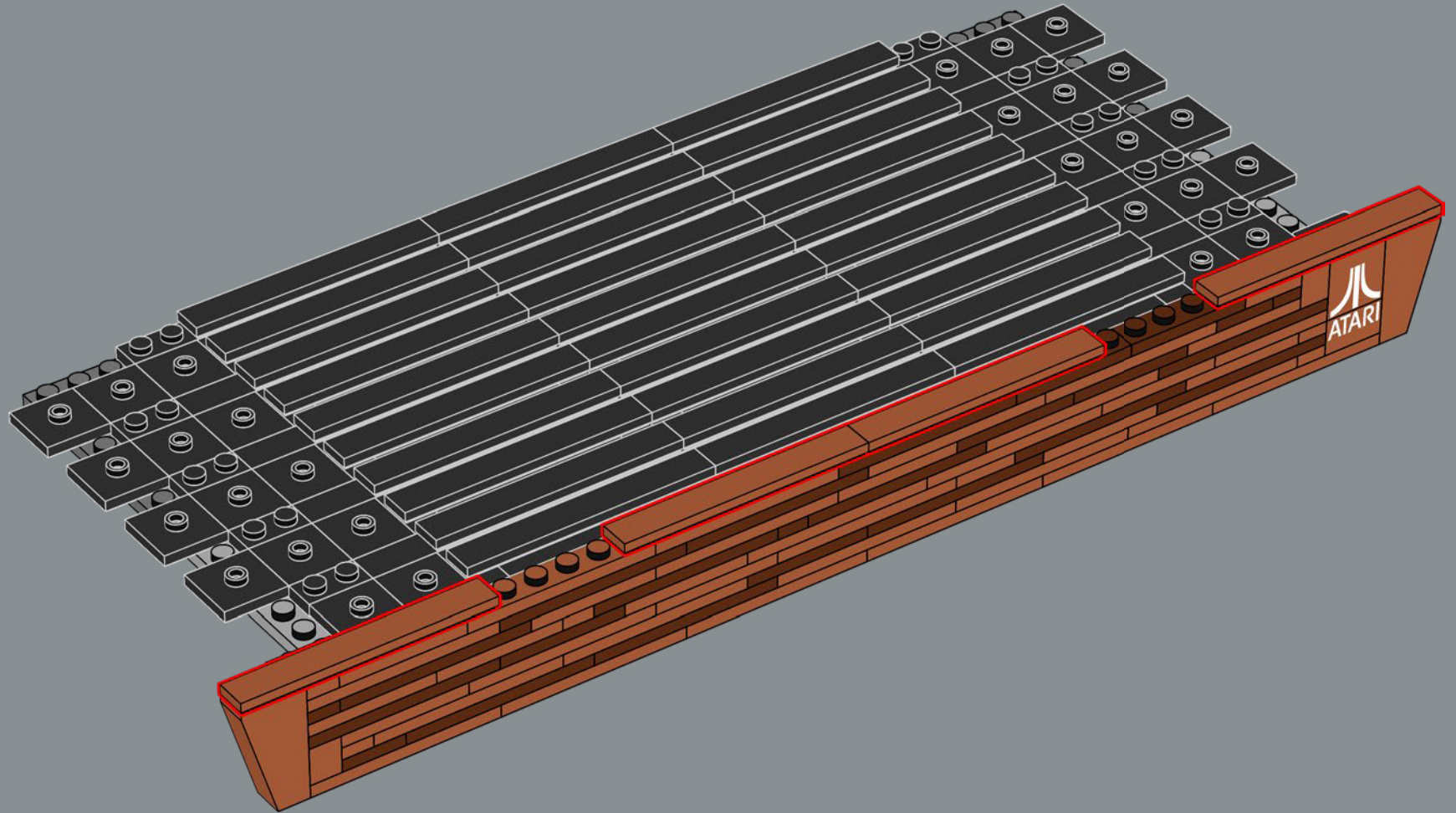

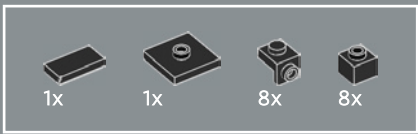

191

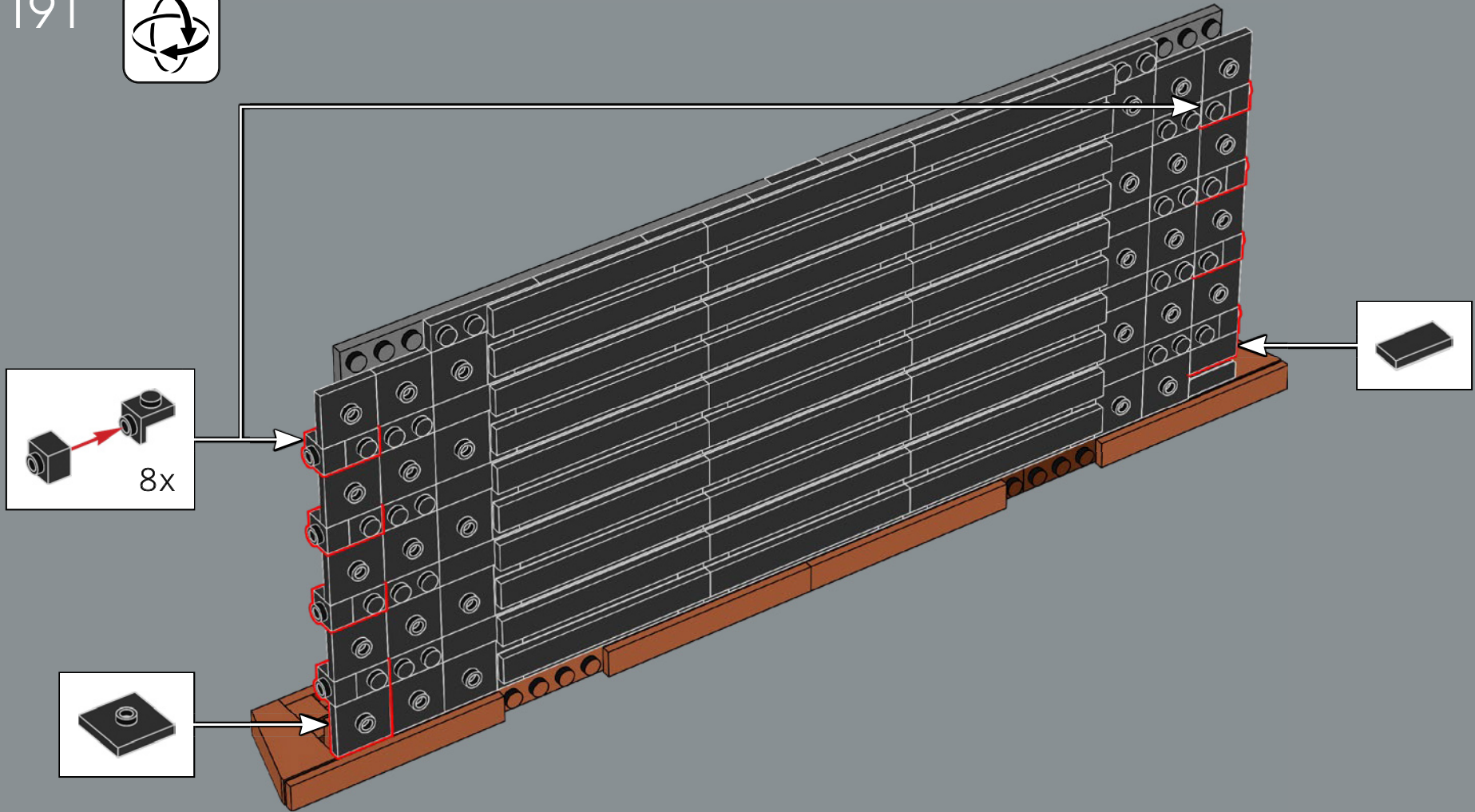

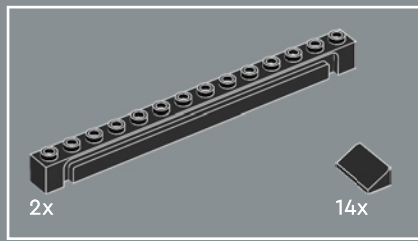

192

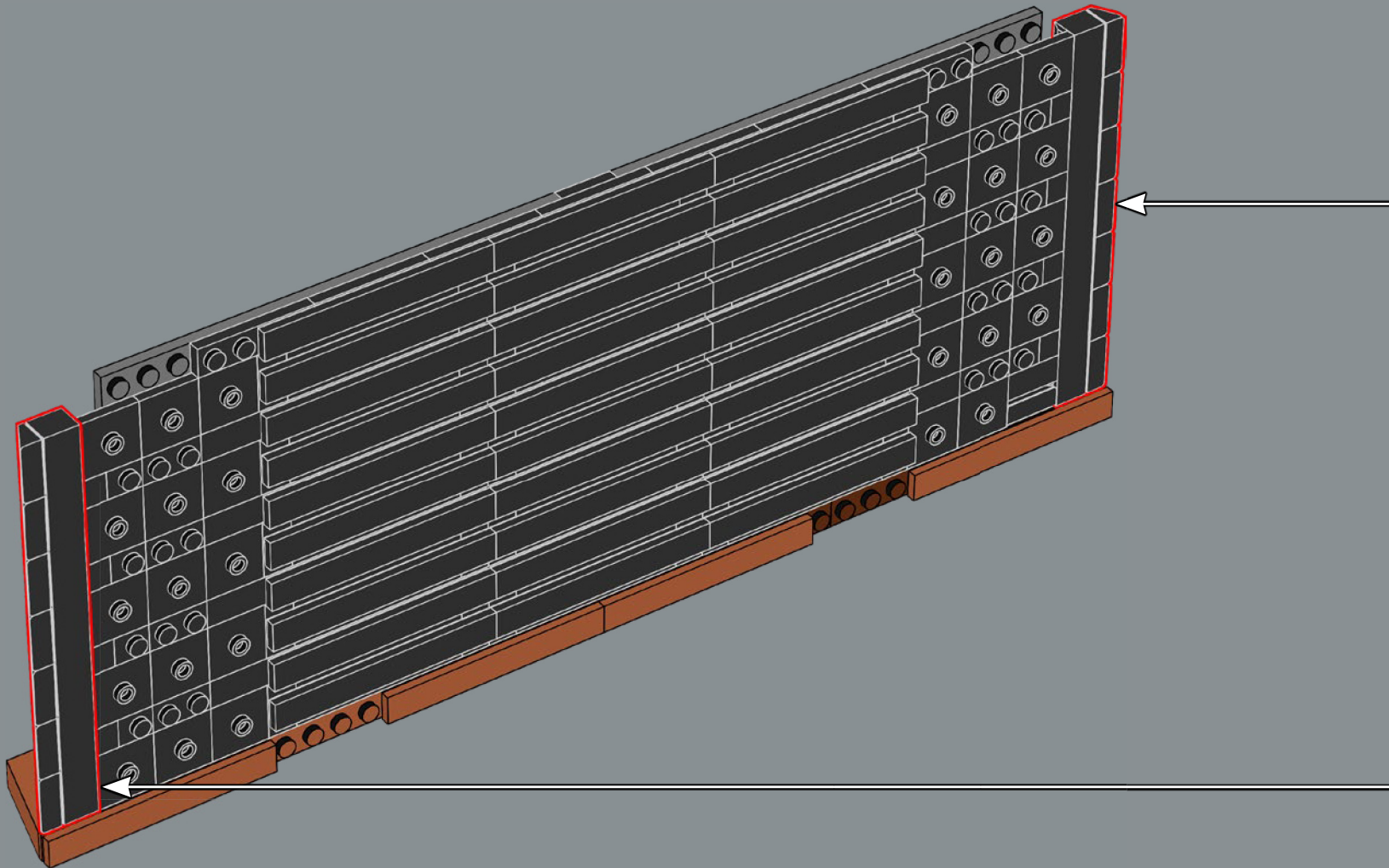
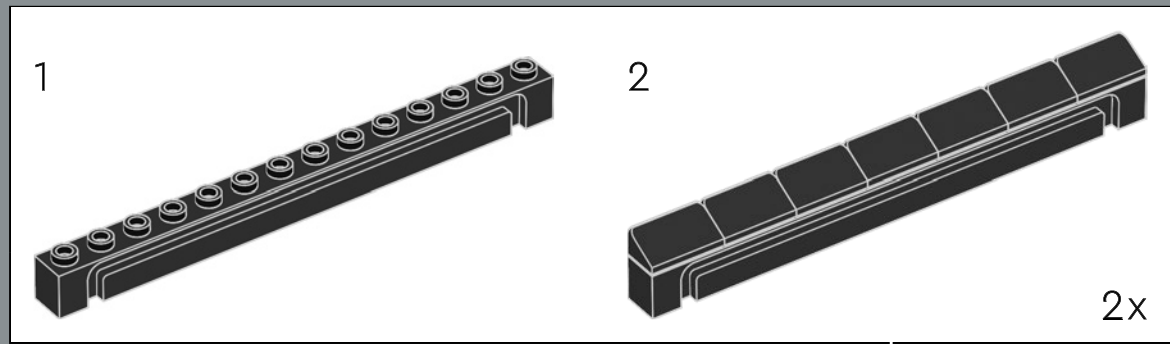

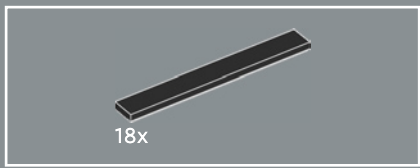

193

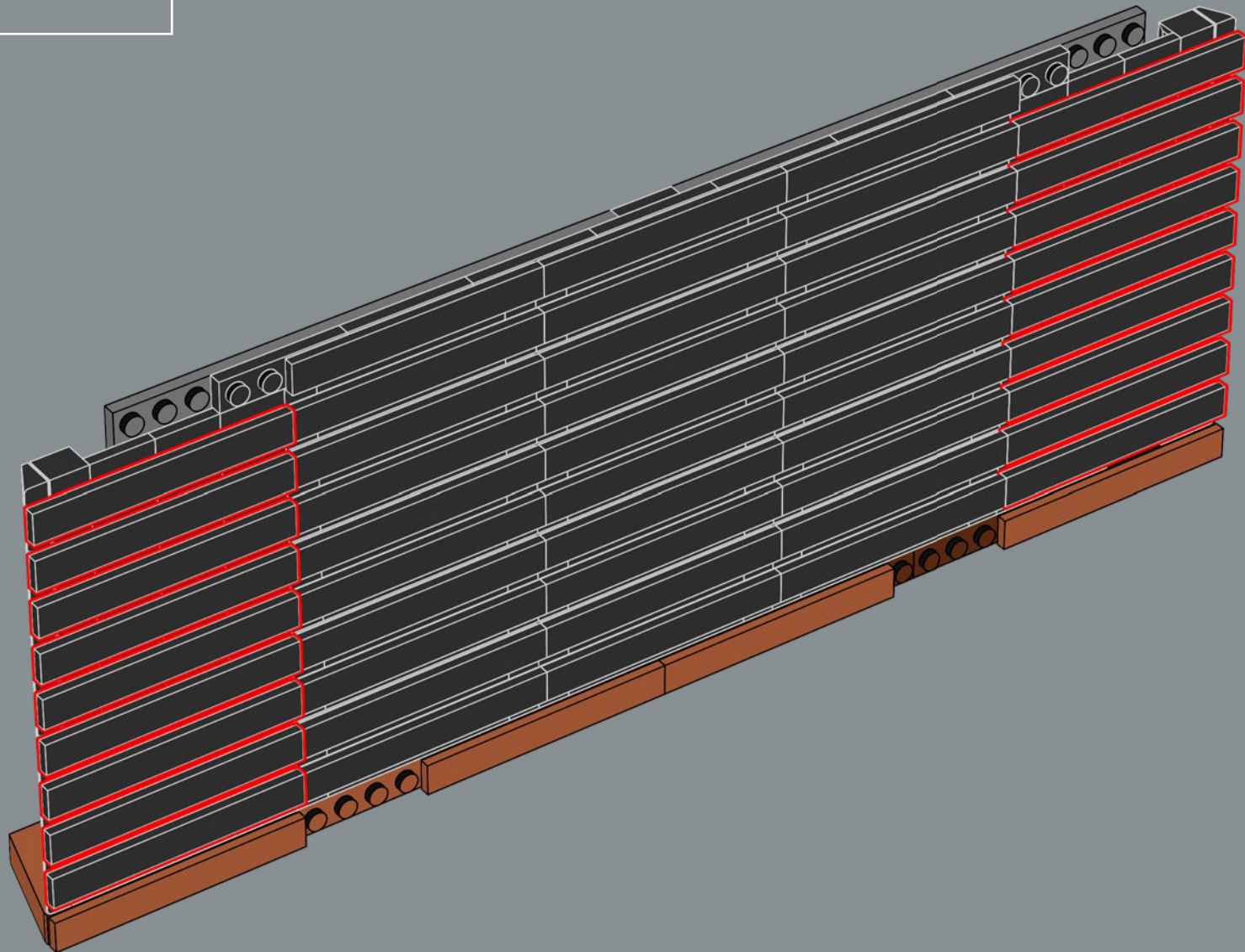



194

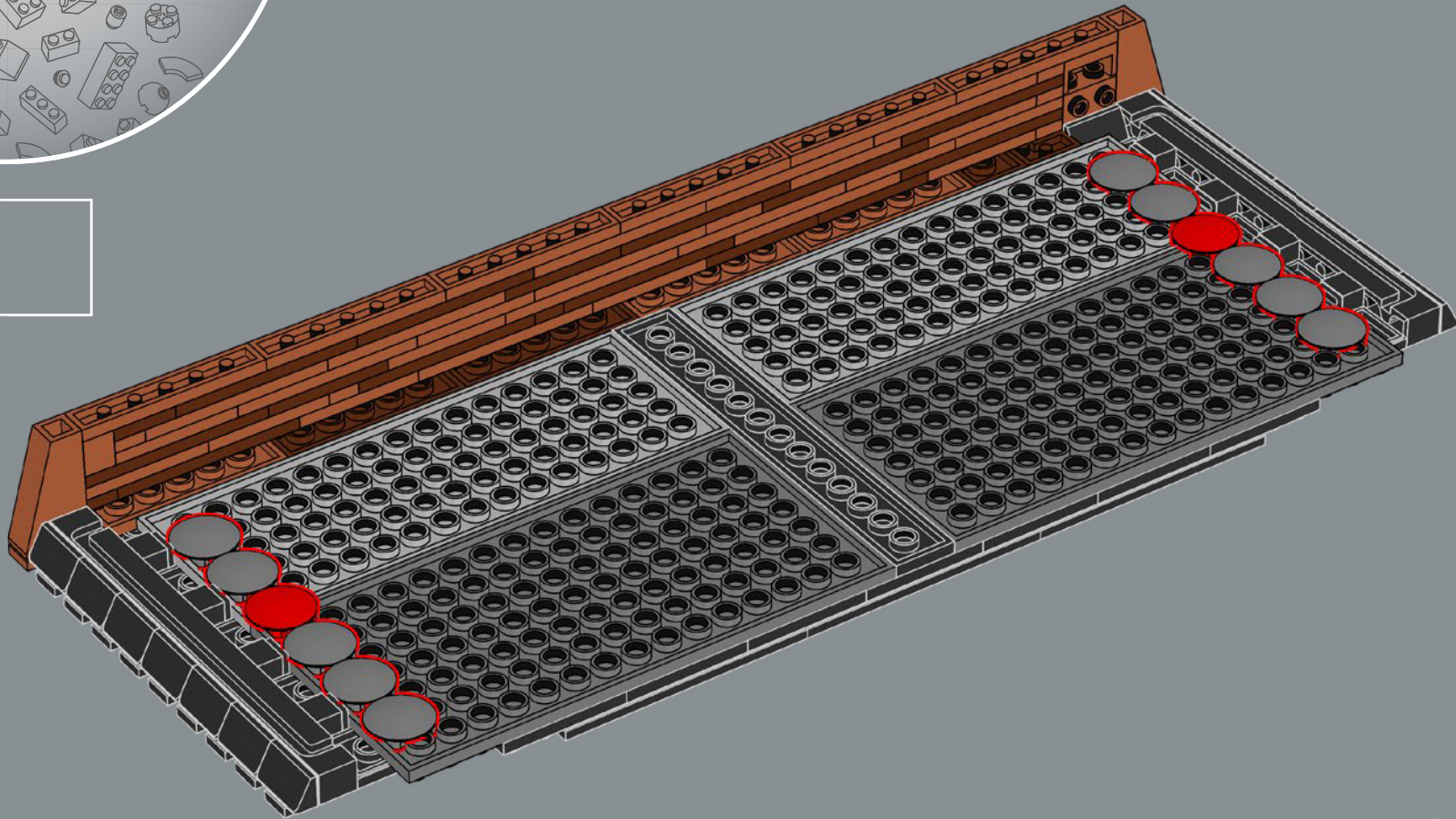

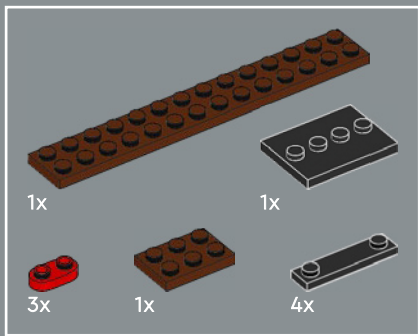

195

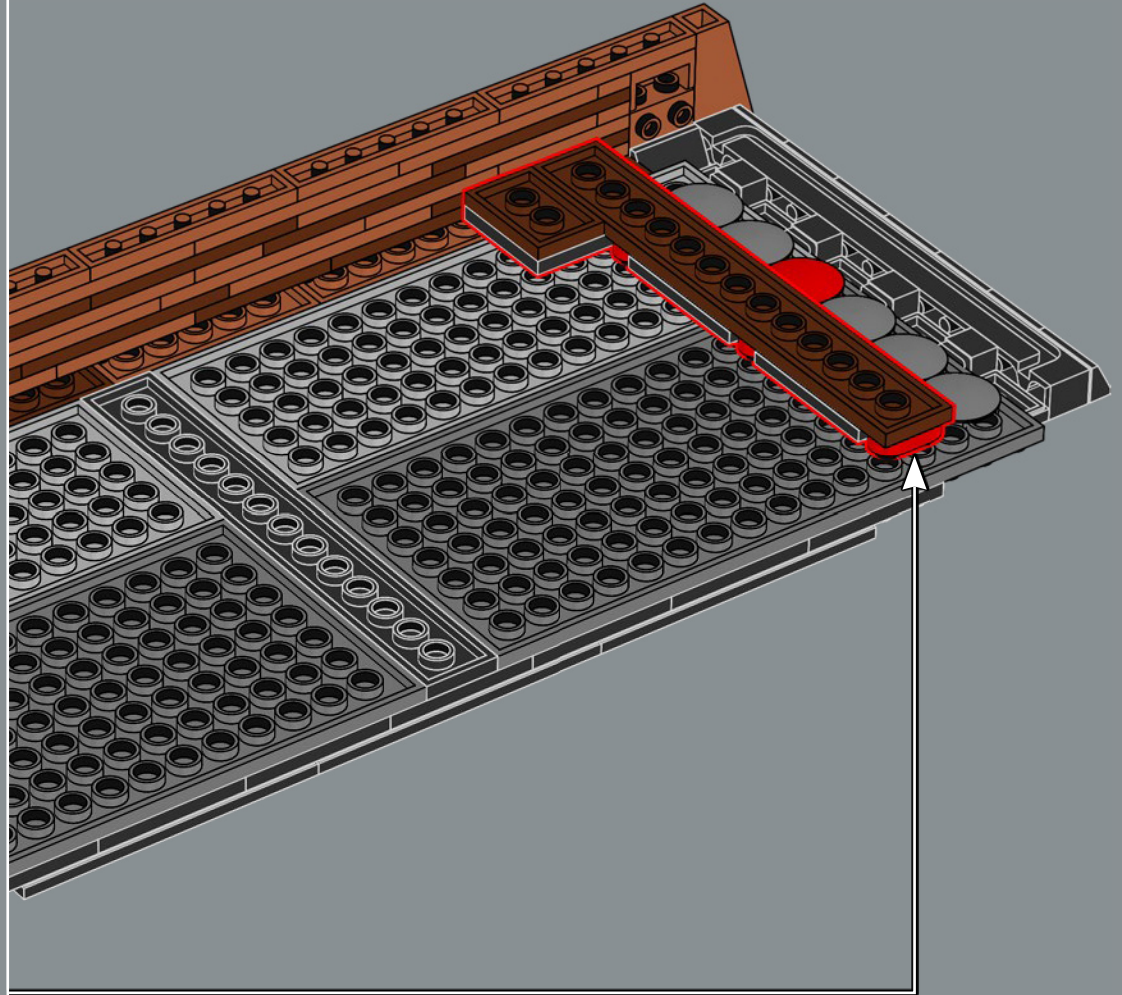
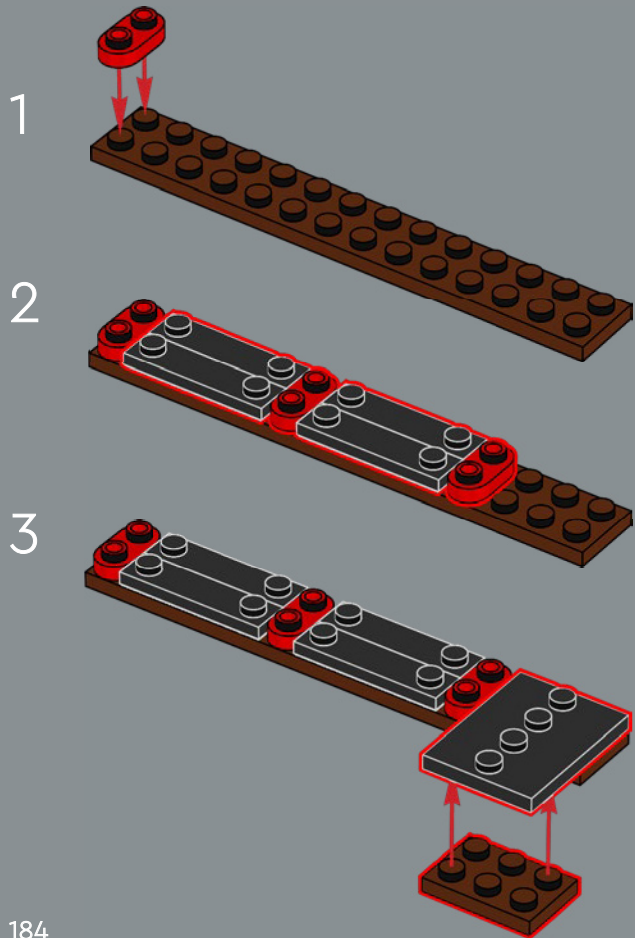

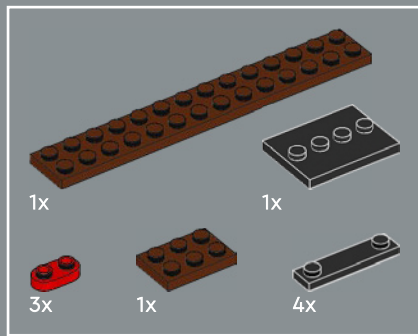

196

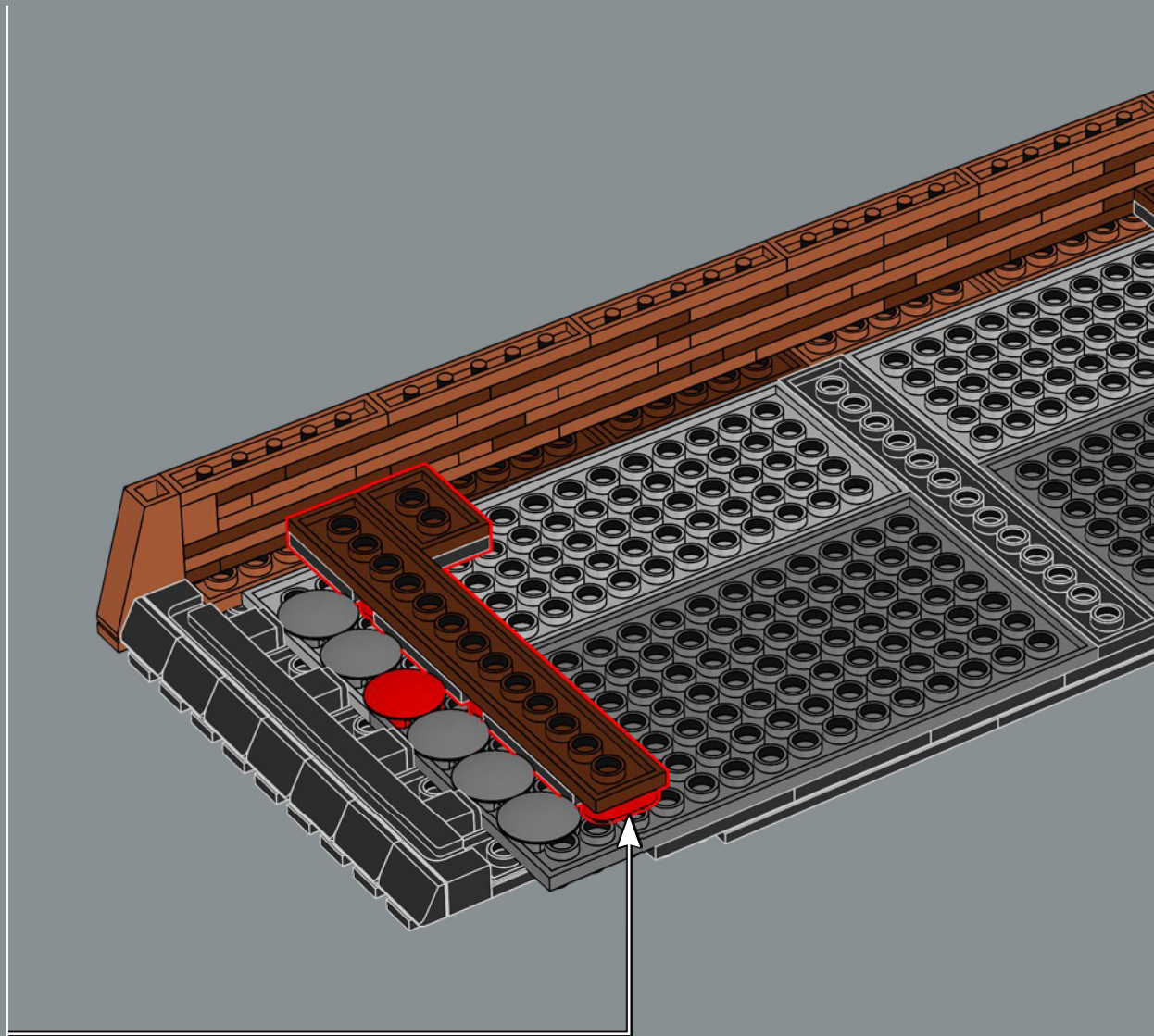
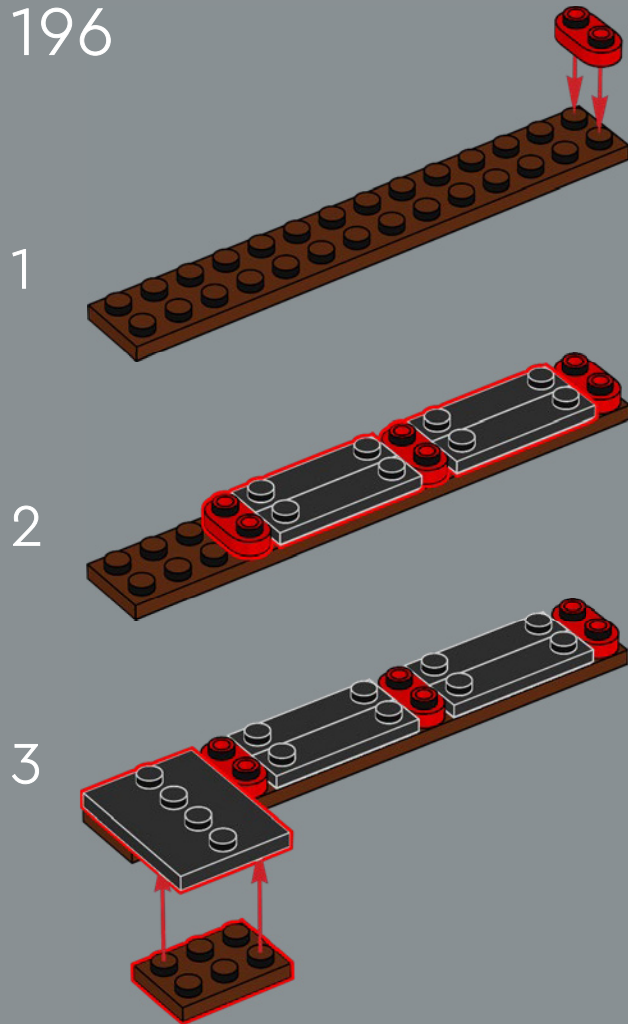

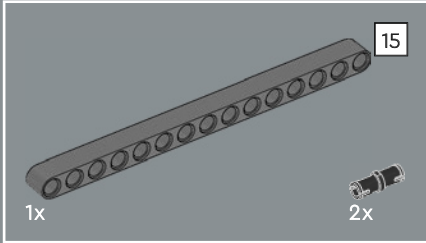
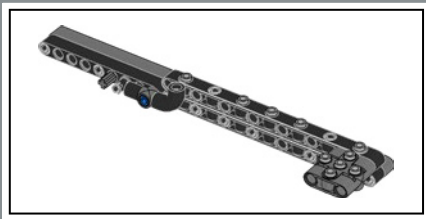

197

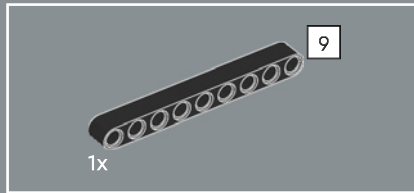
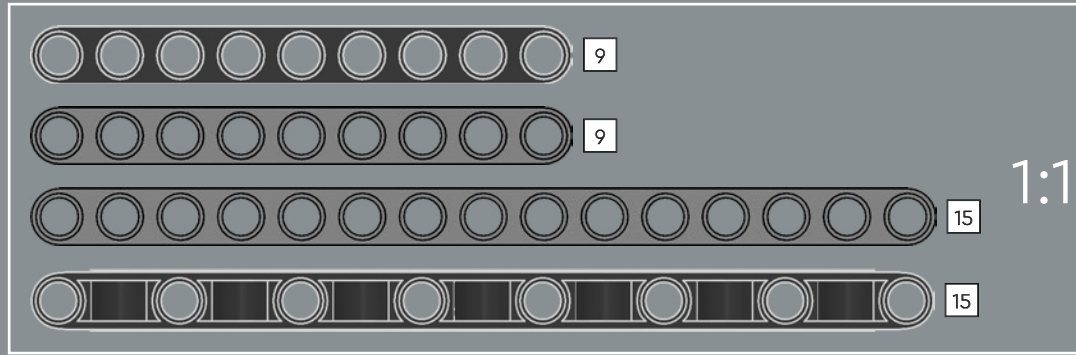

198



199

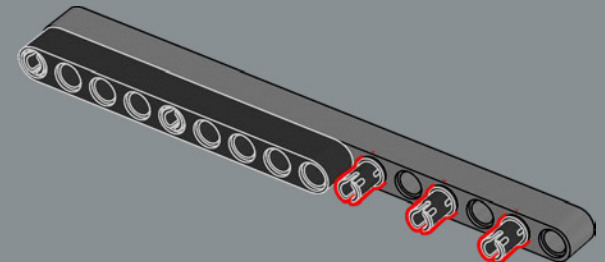
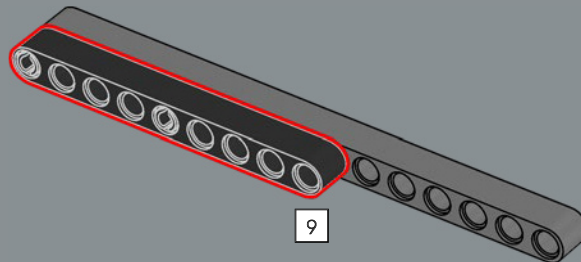
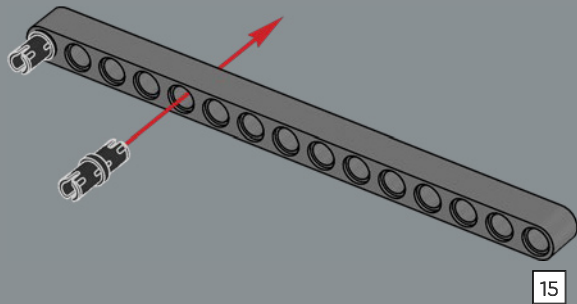

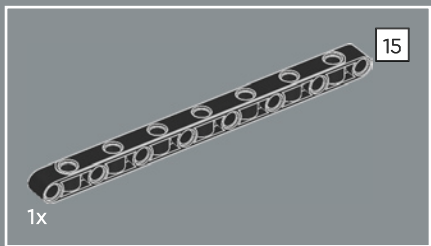

200

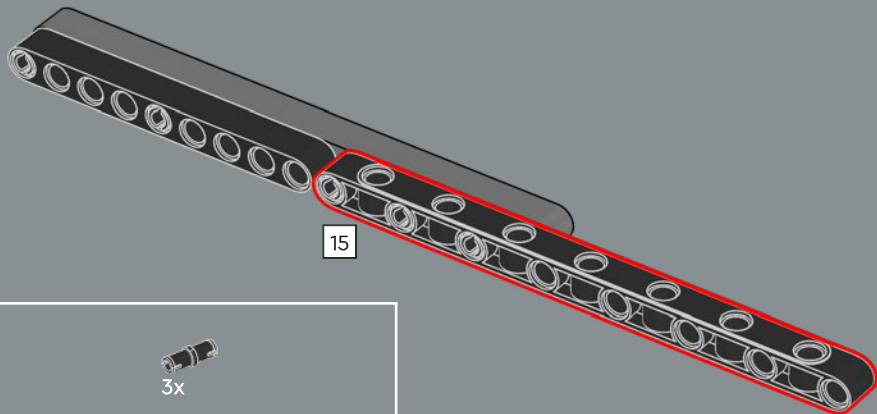

201

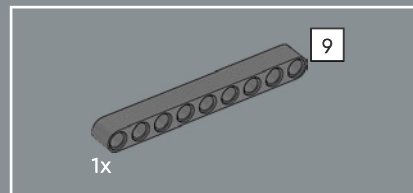
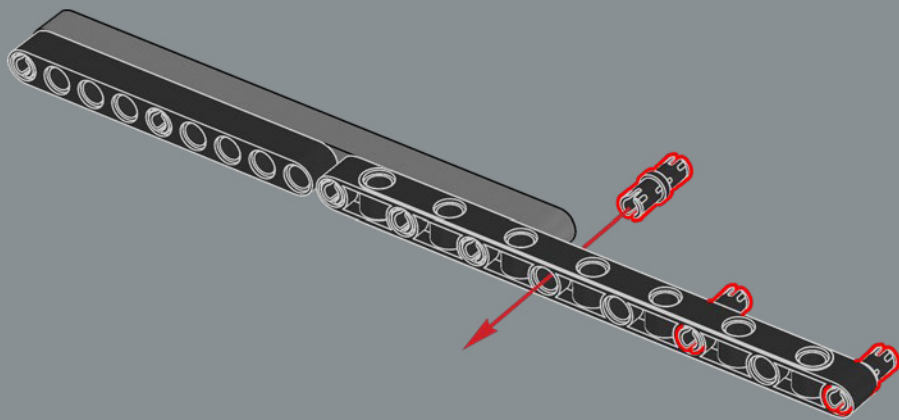

202

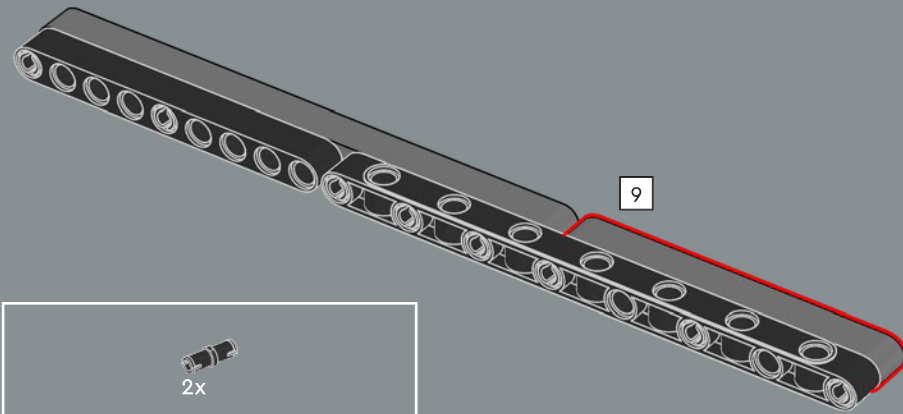

203

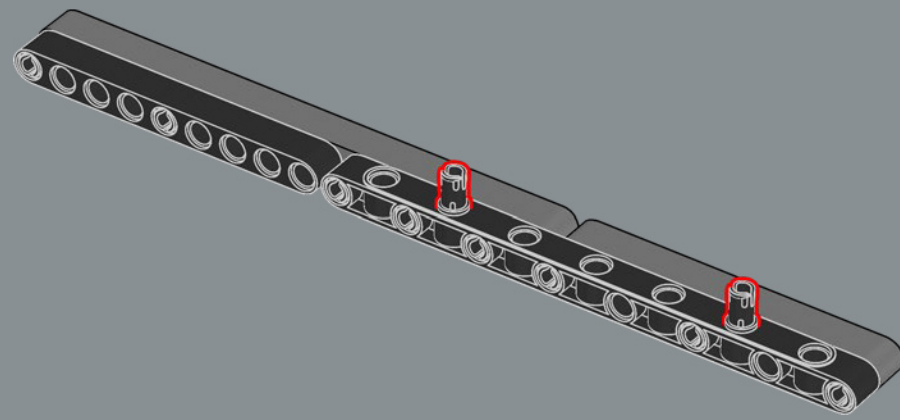

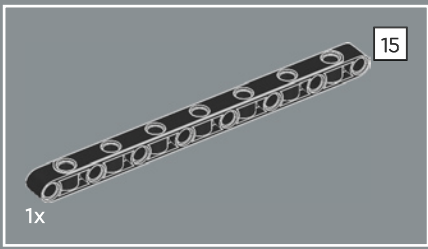

204

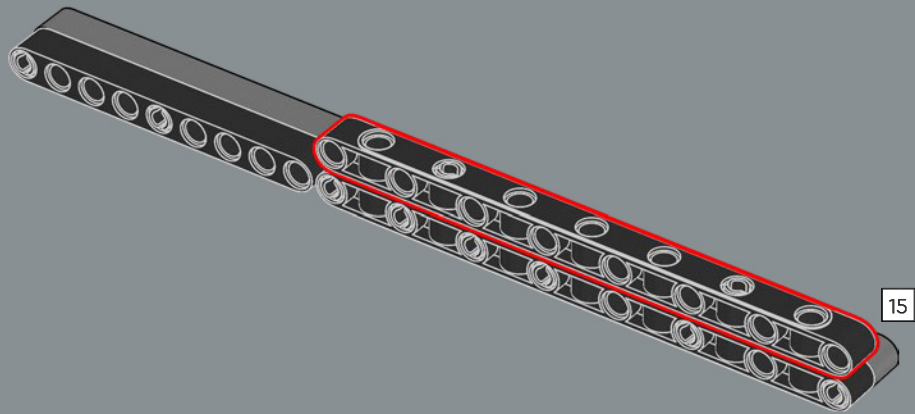

205

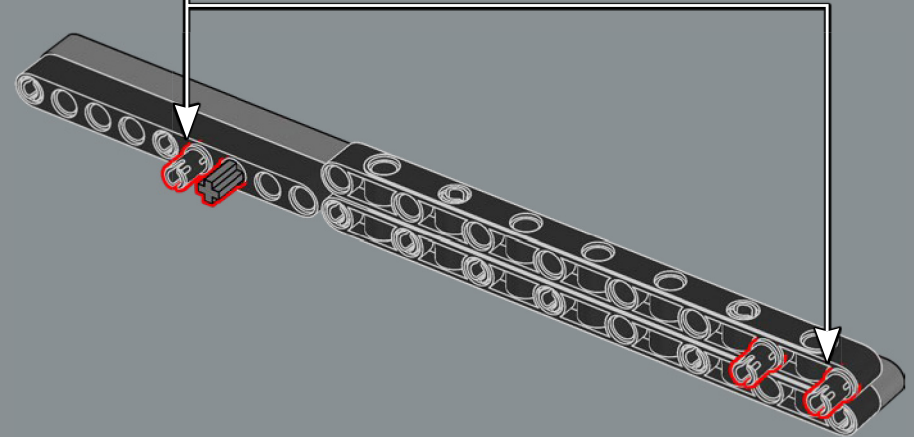
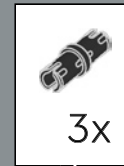

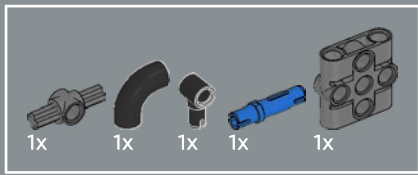

206

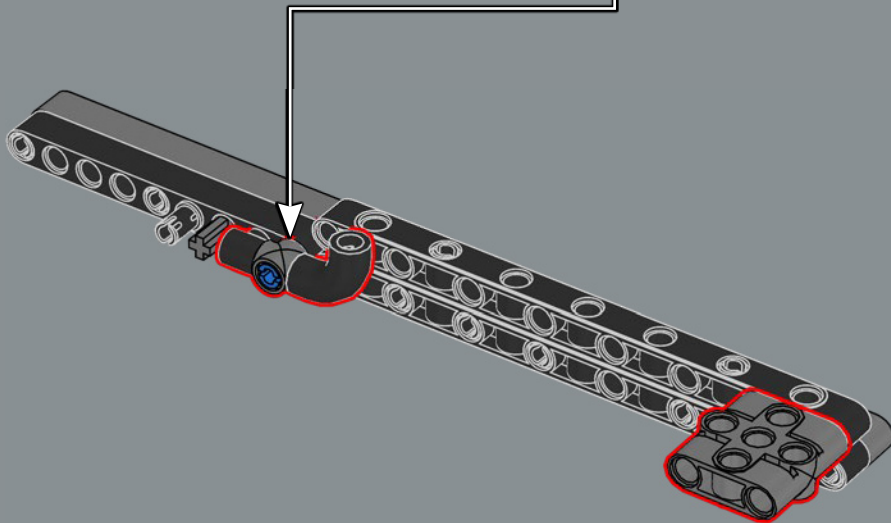
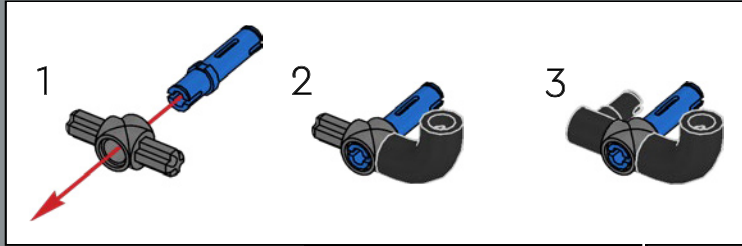

207

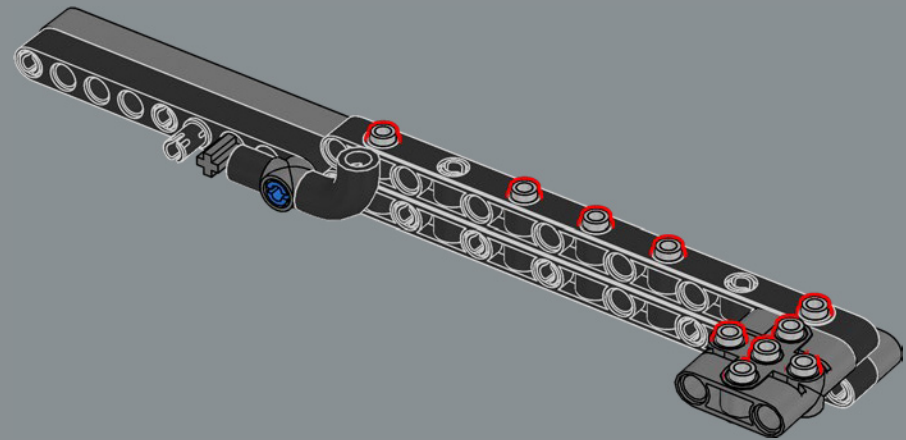

208

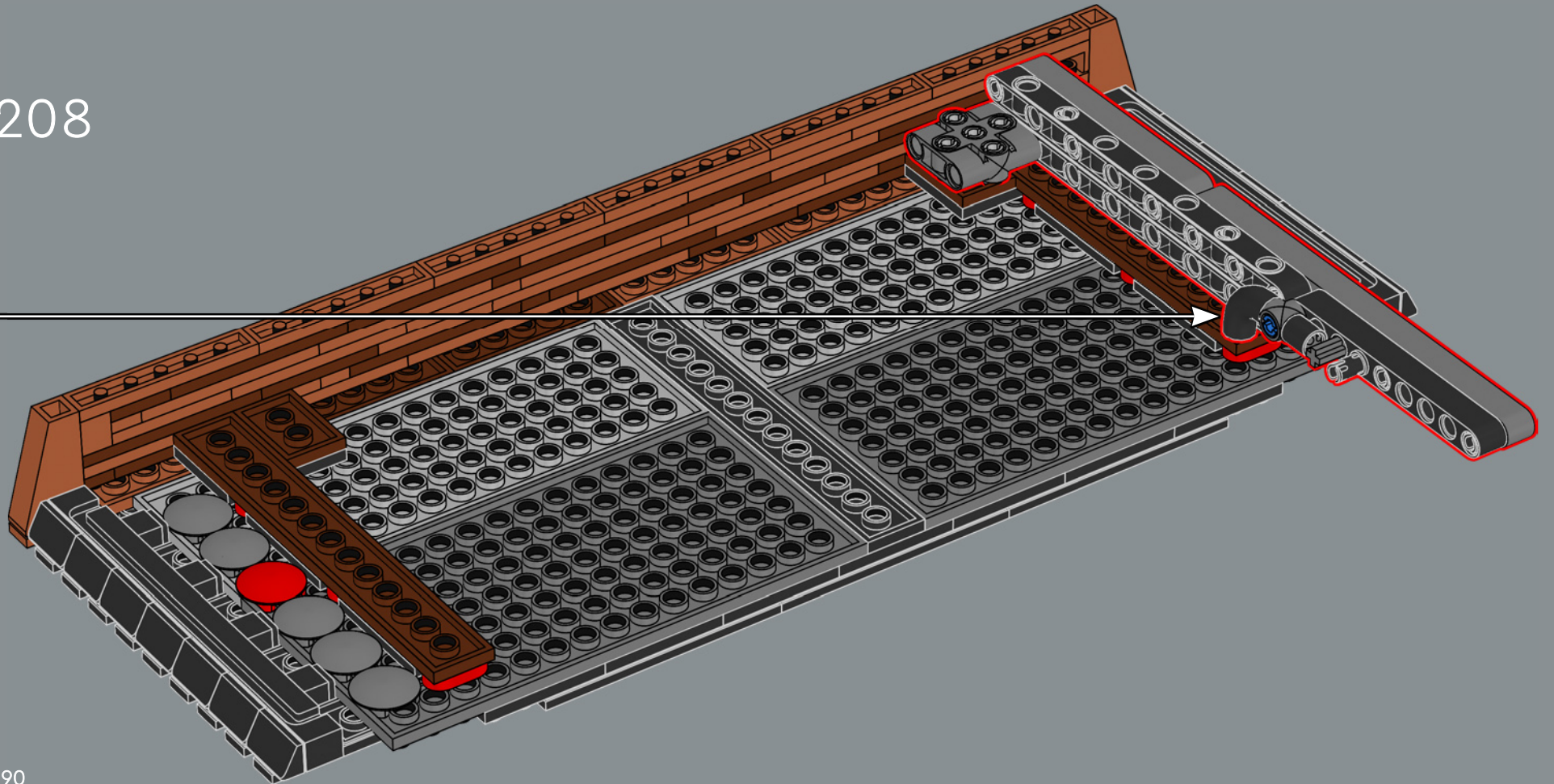

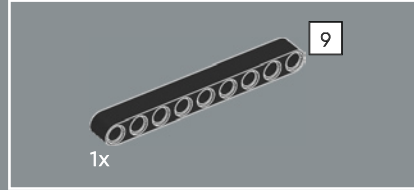
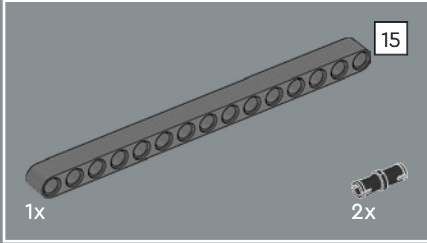
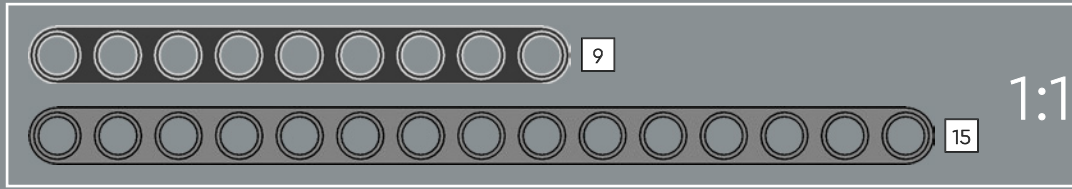
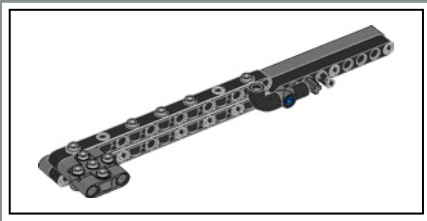

209

210

211

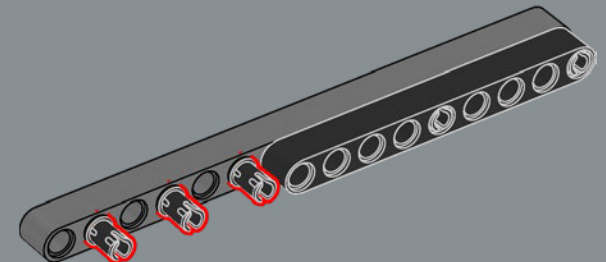
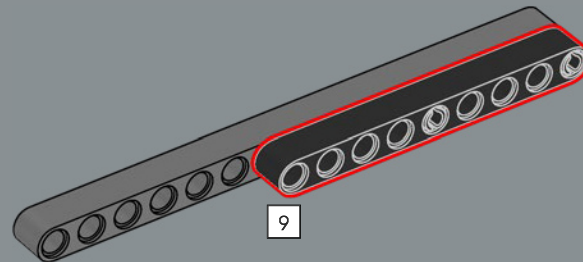
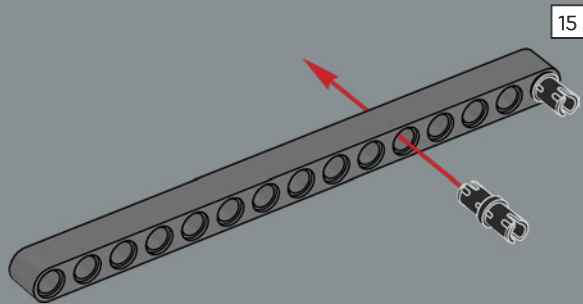

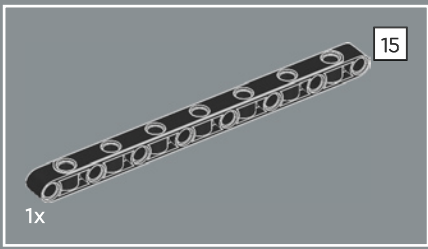

212

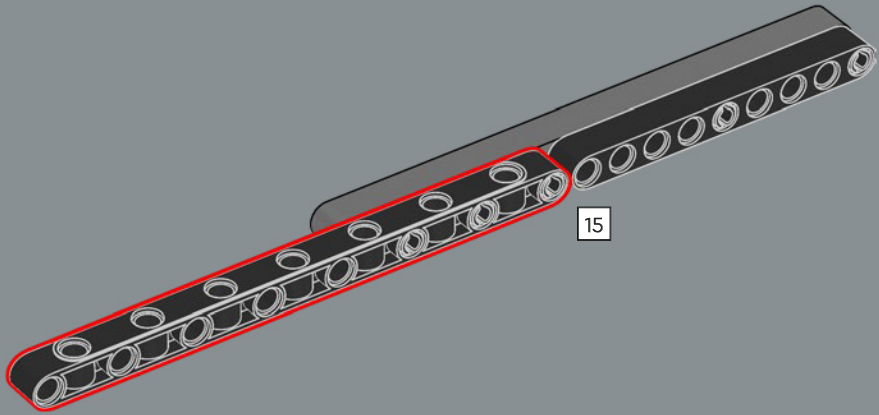

213

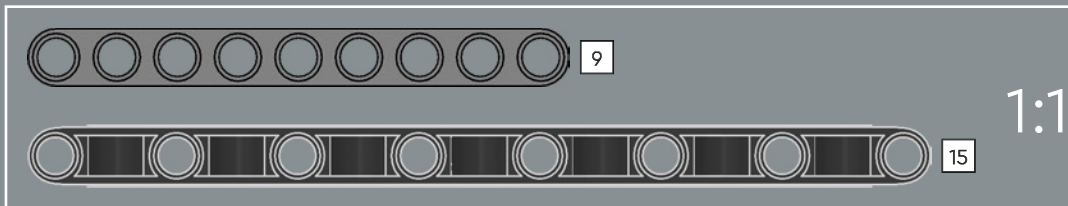
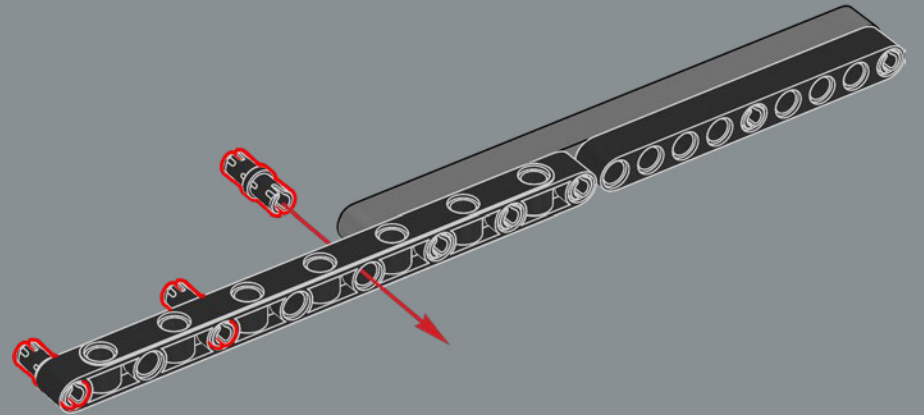

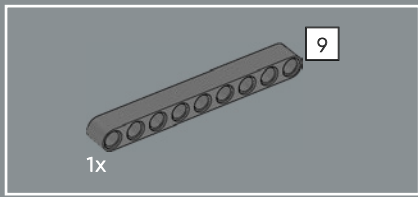

214

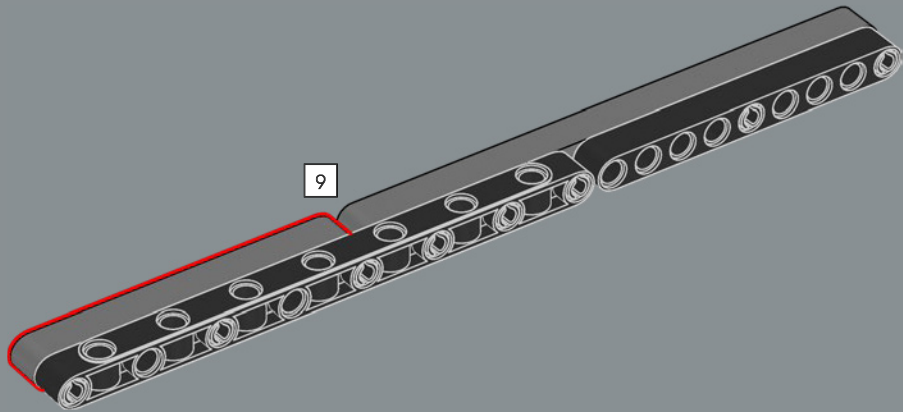

215

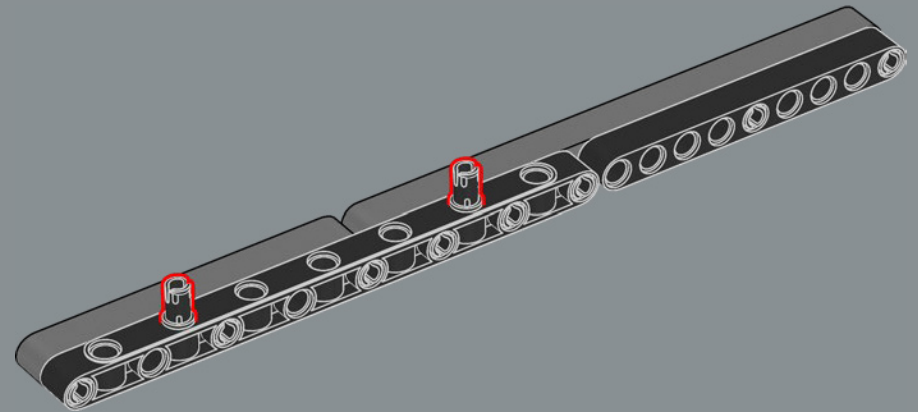

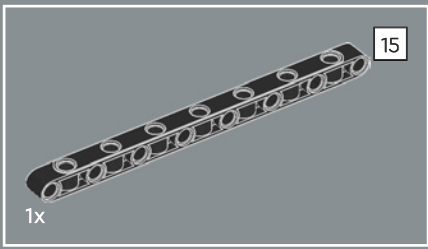

216

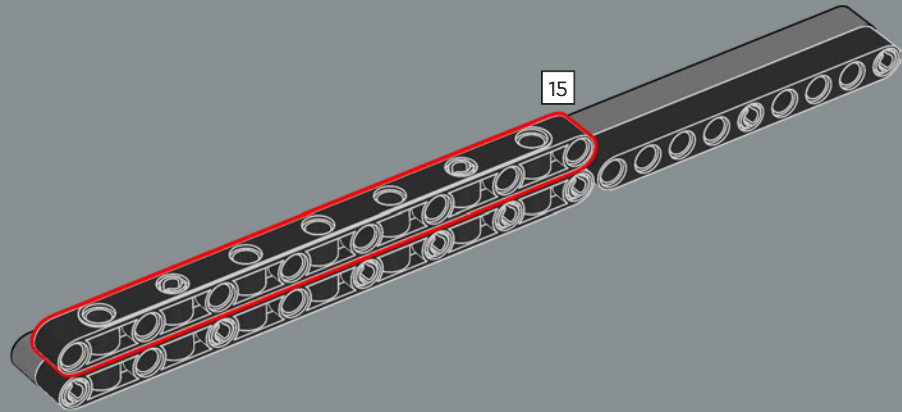

217

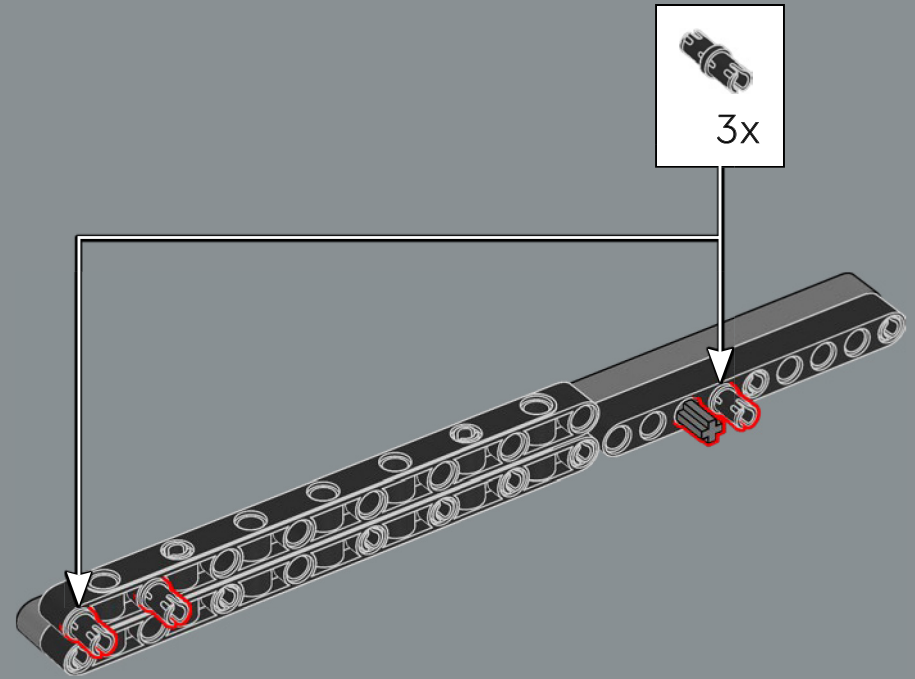



218

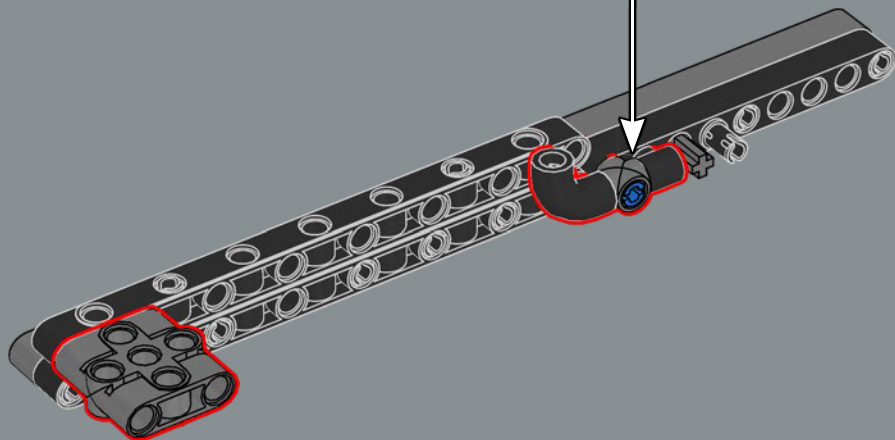
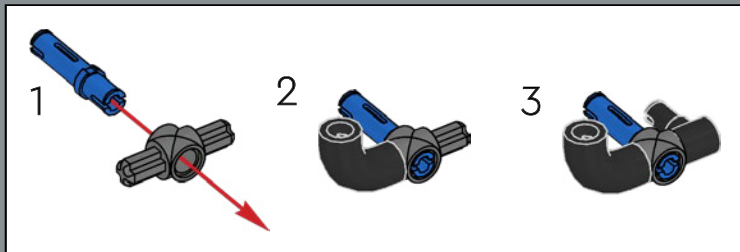

219

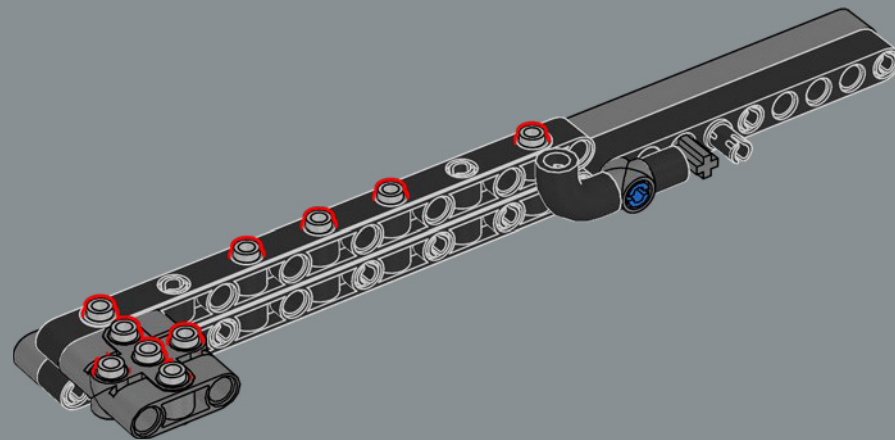

220

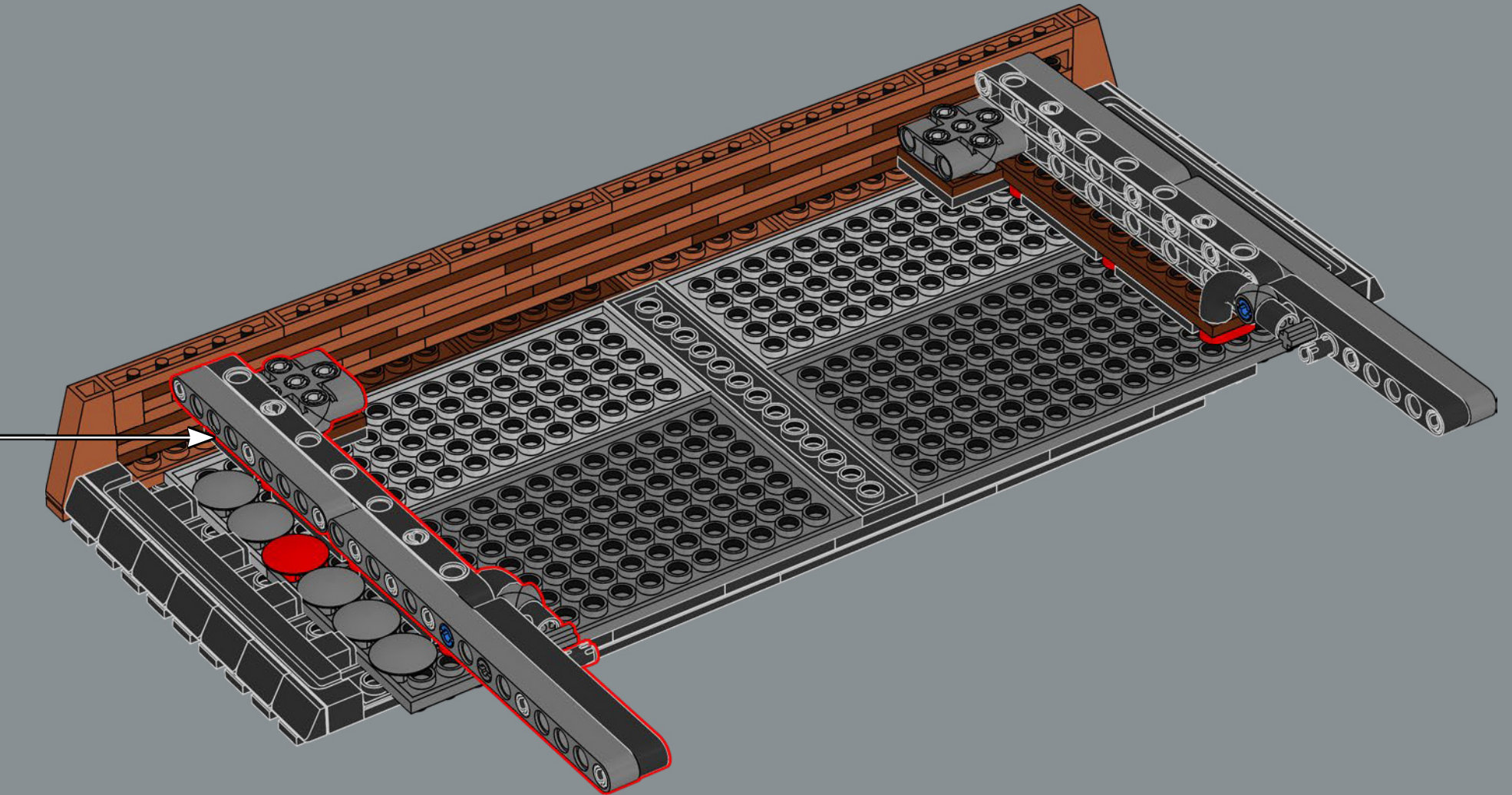

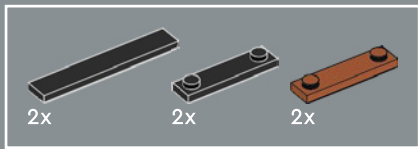

221

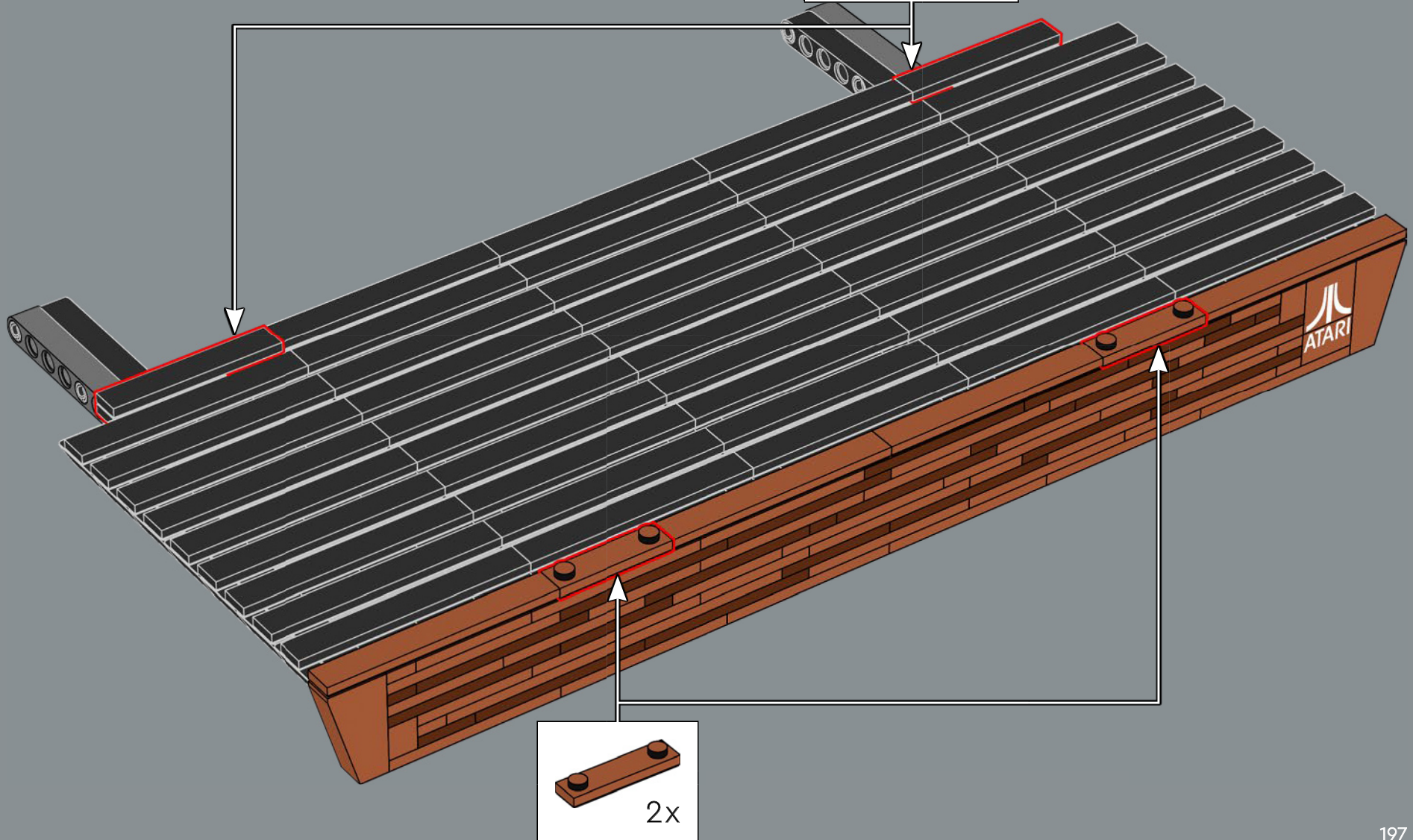
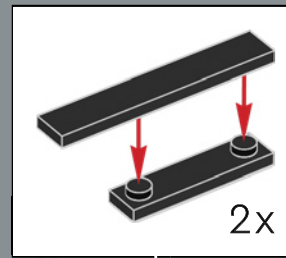

222

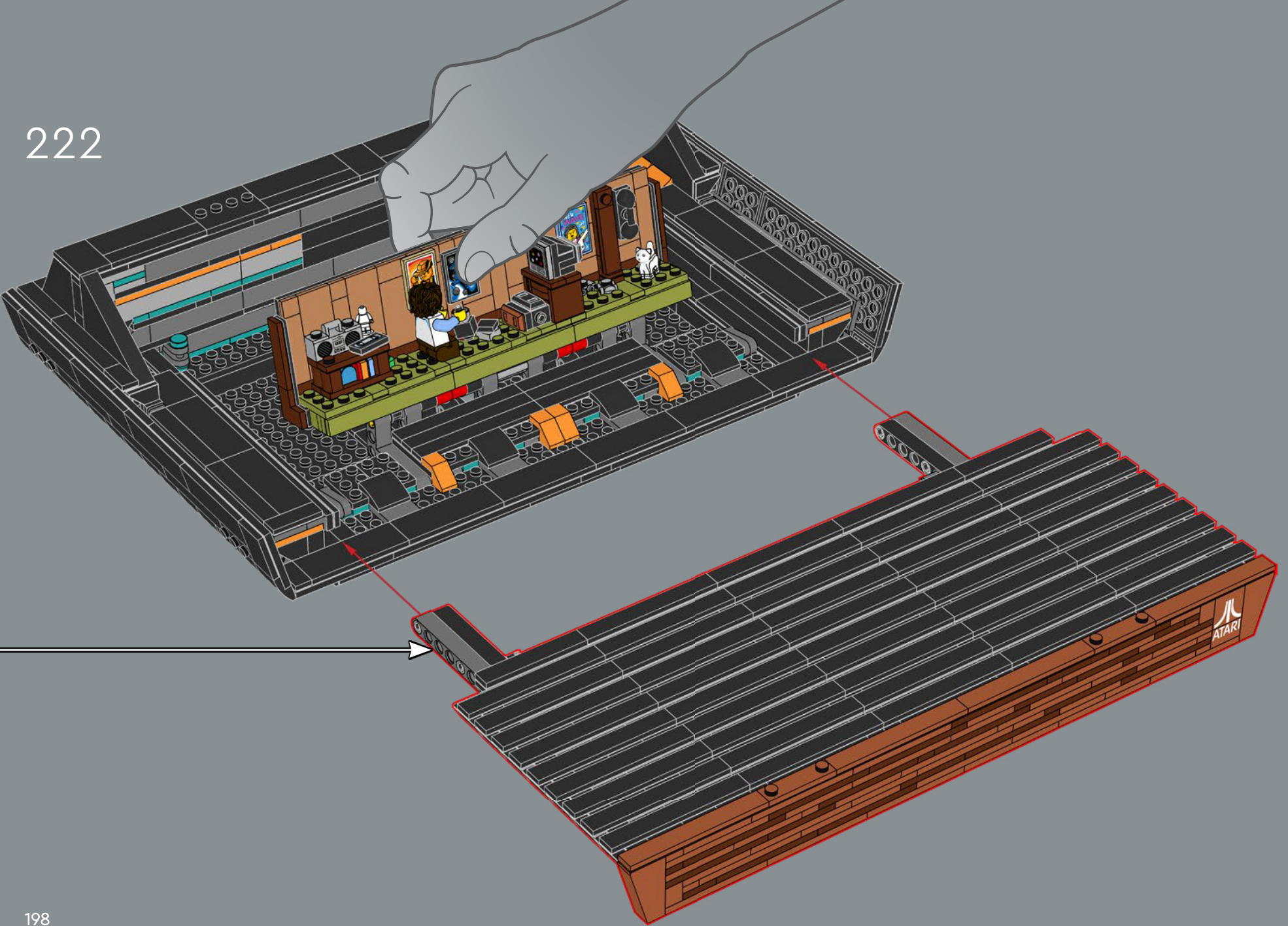

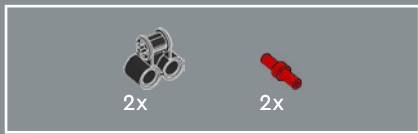

223

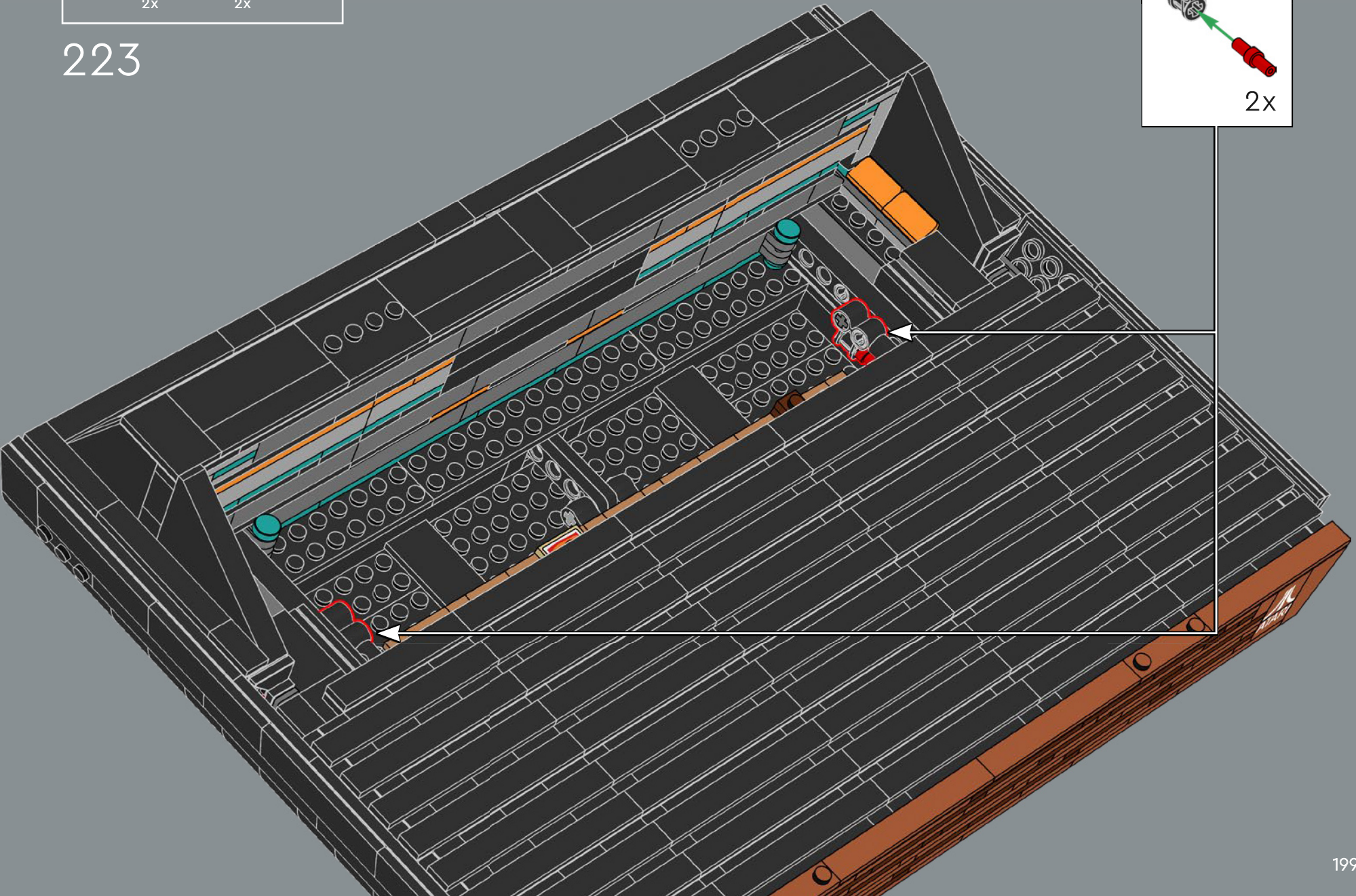
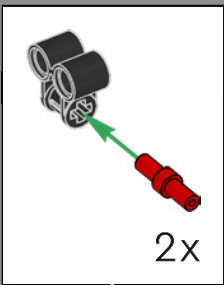





224

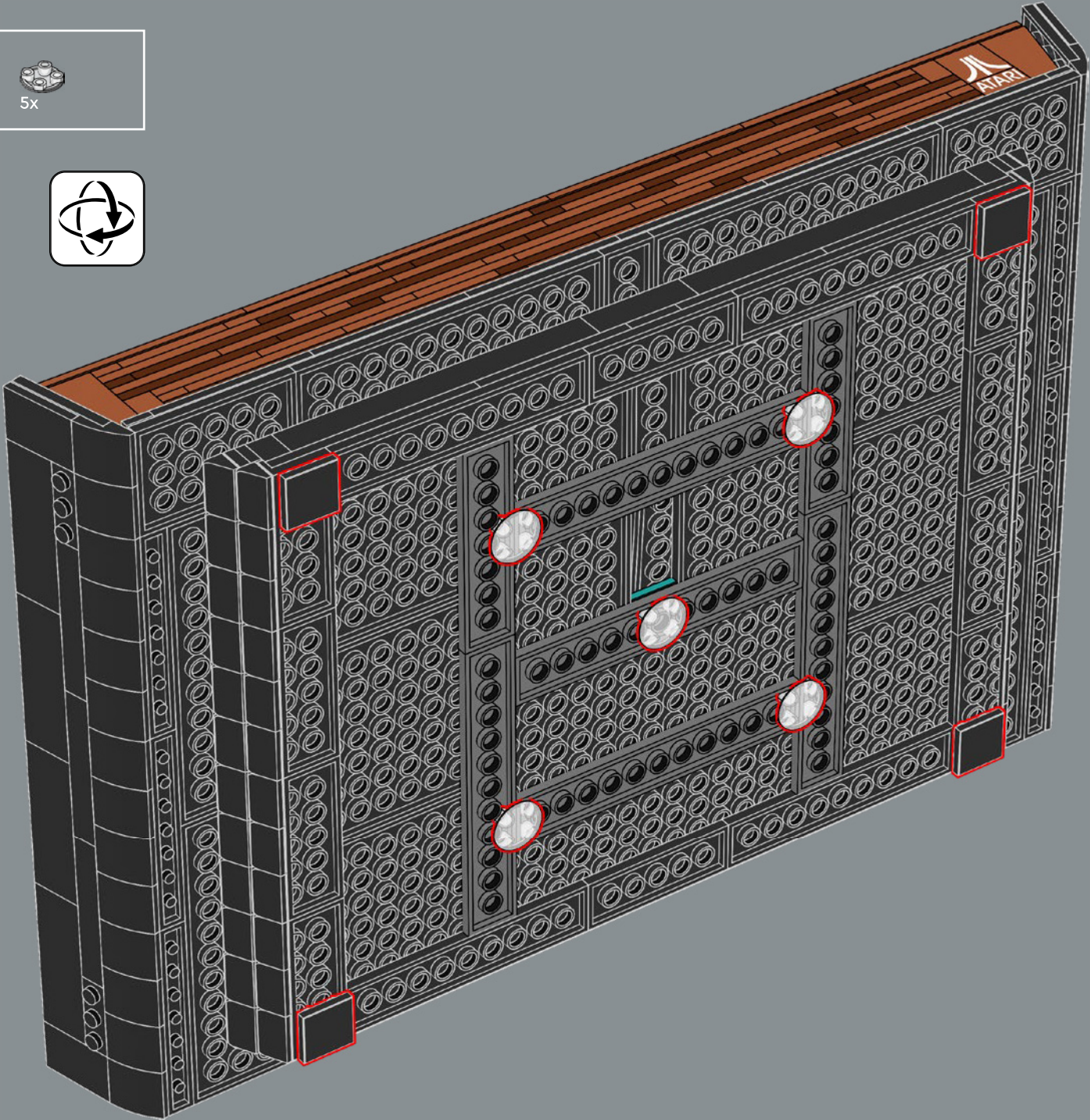

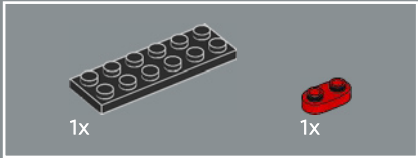
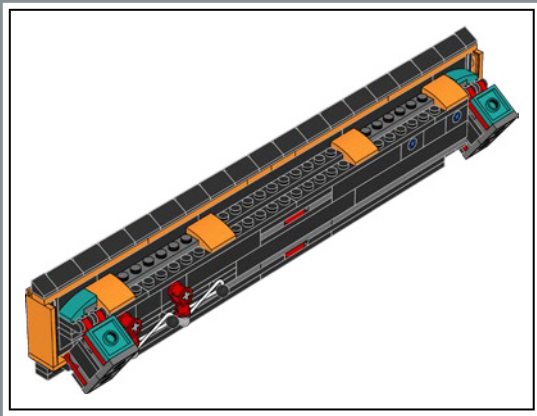

225

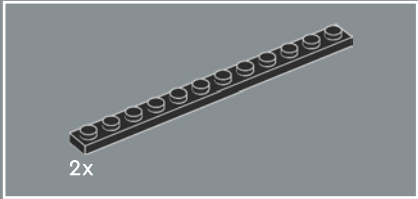
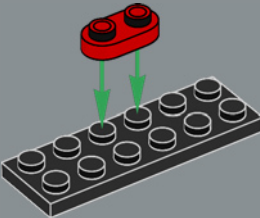

226

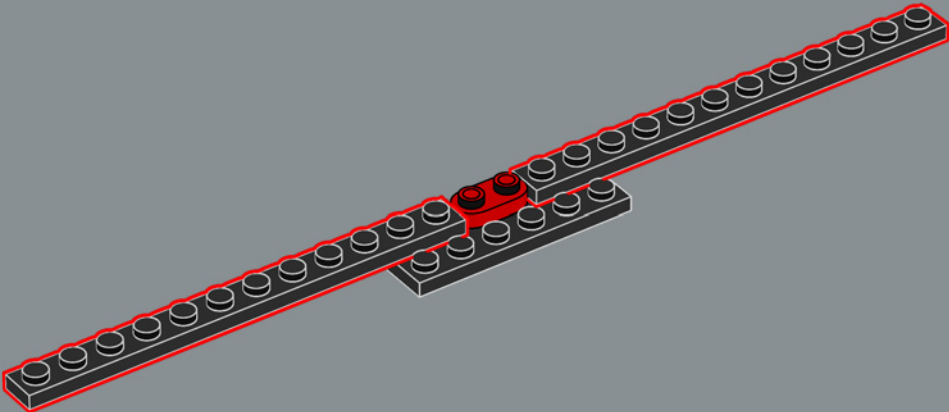

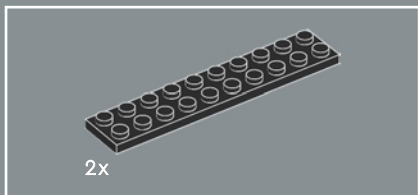

227

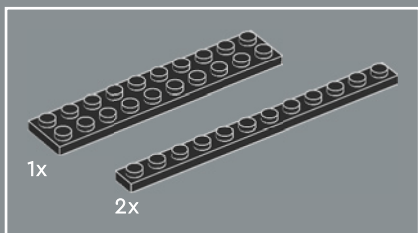
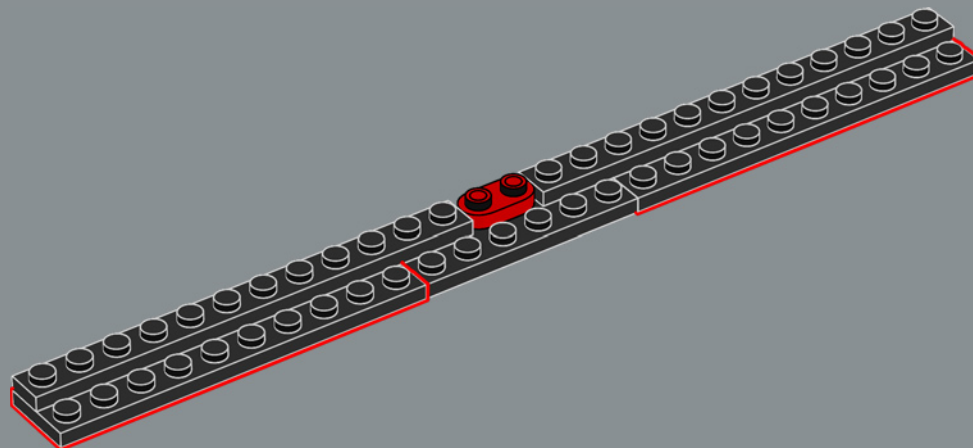

228

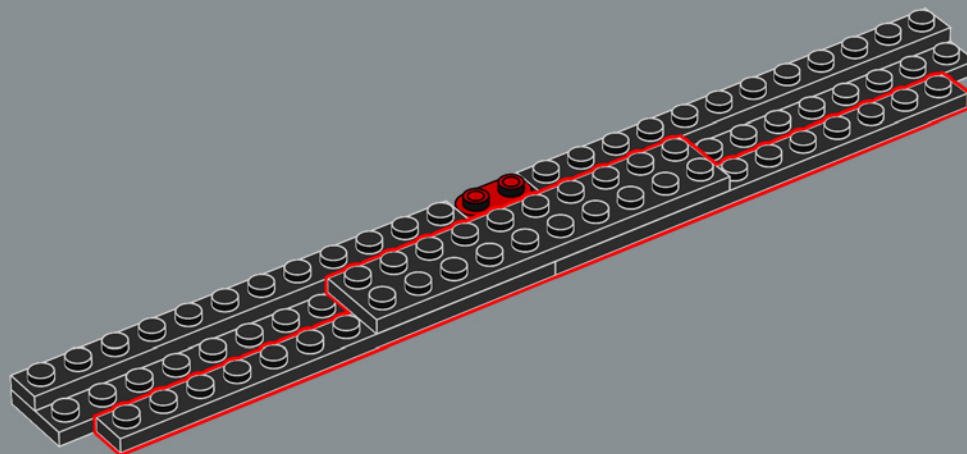

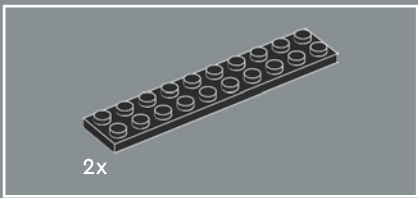

229

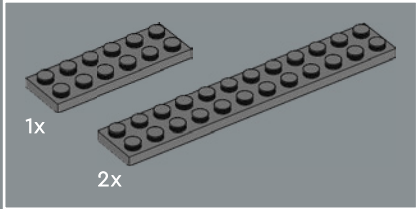
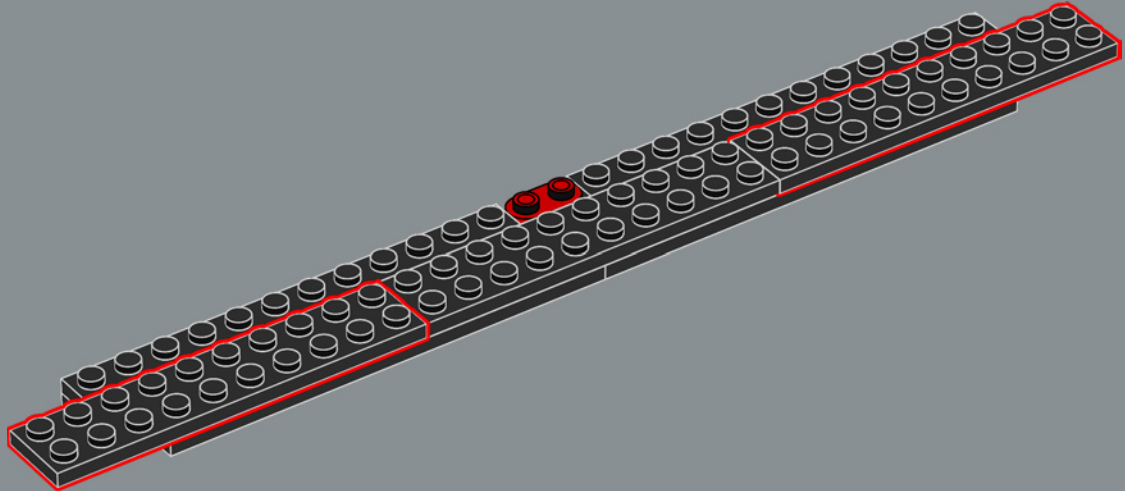

230

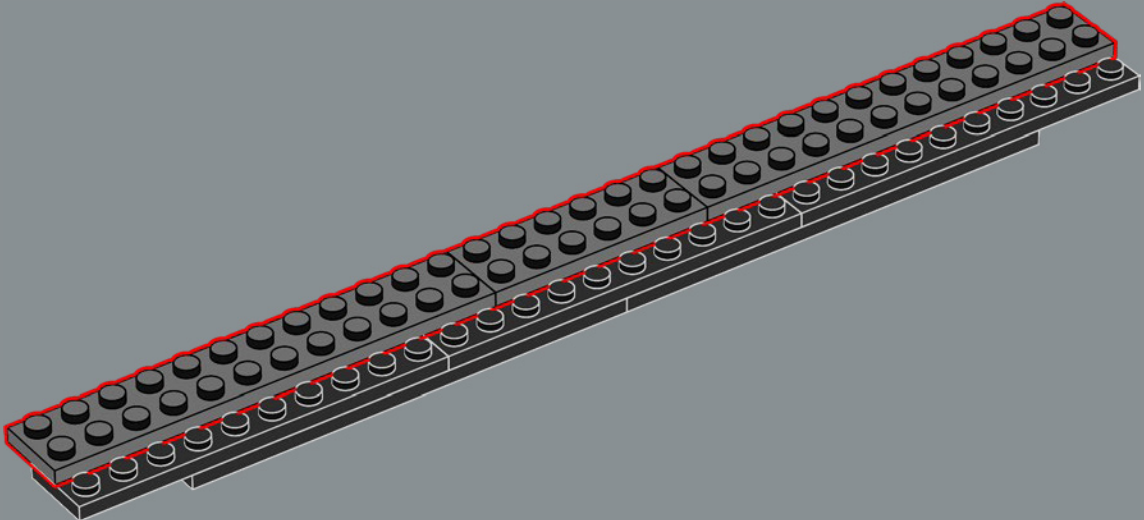

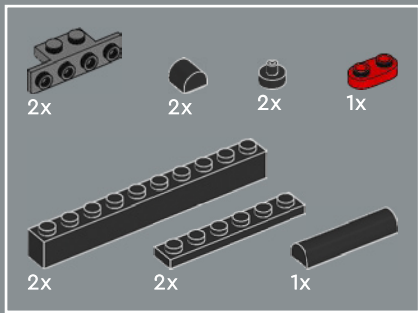

231

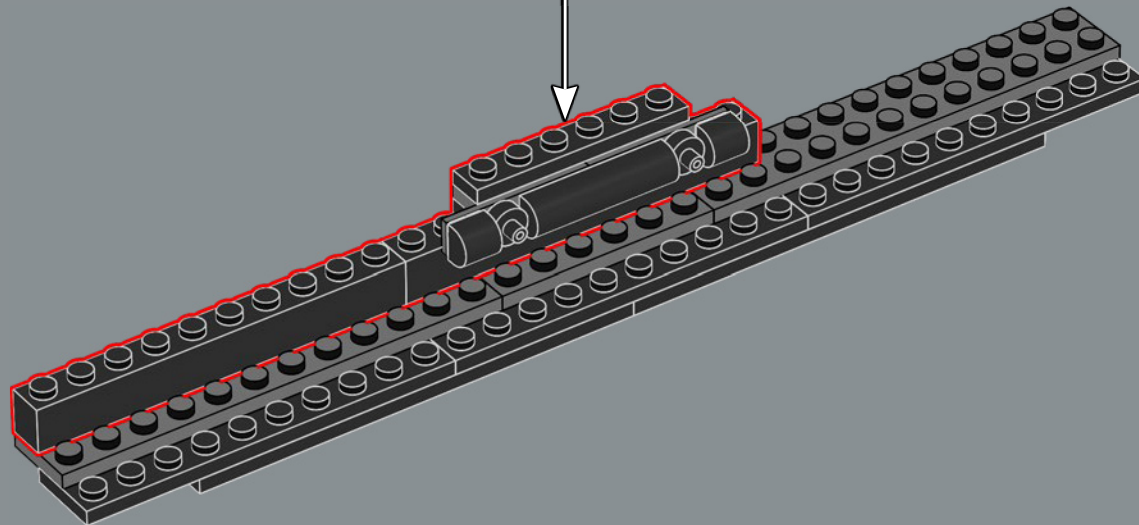
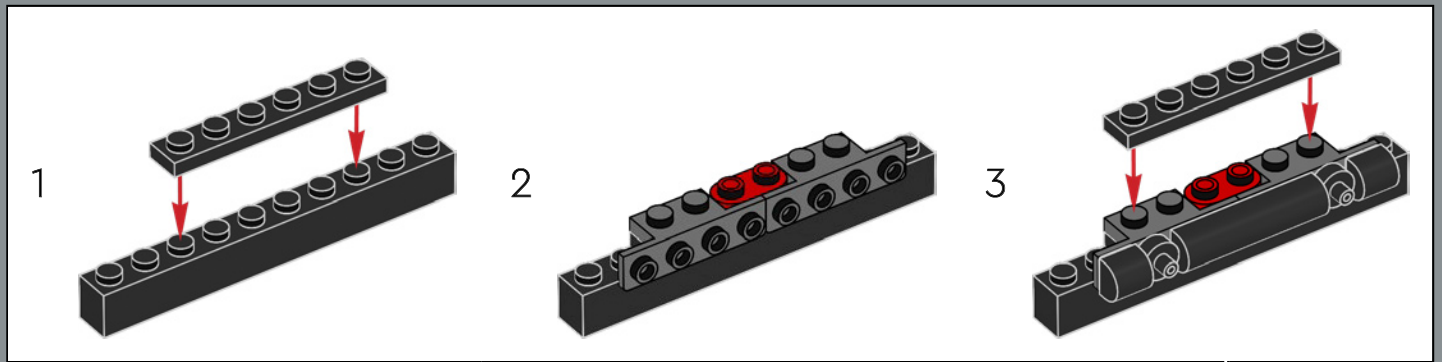

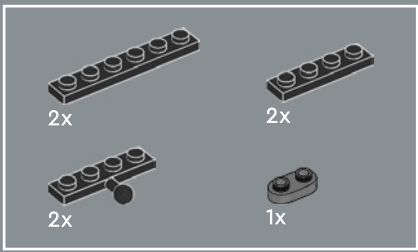

232

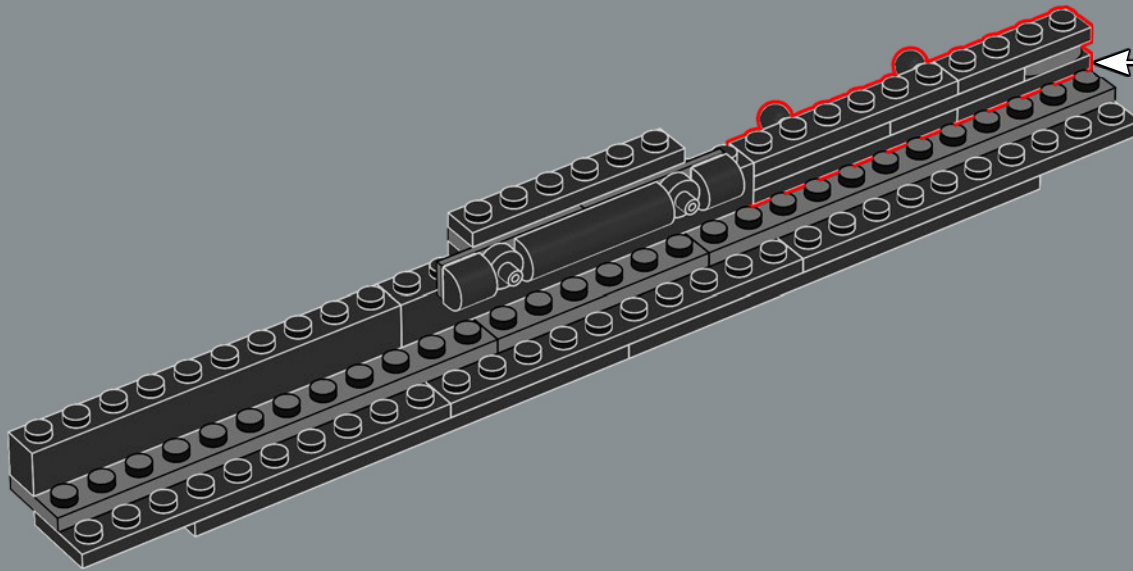
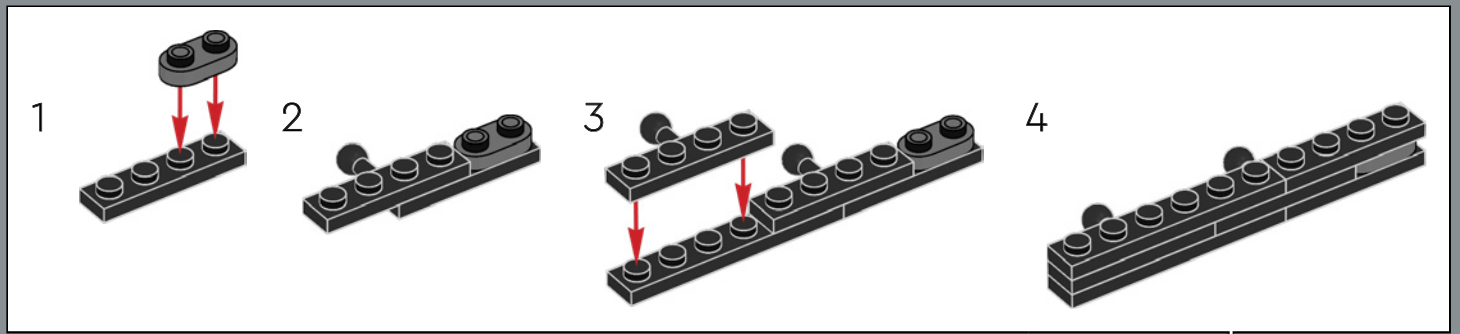

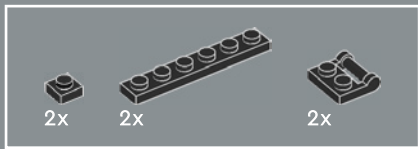

233

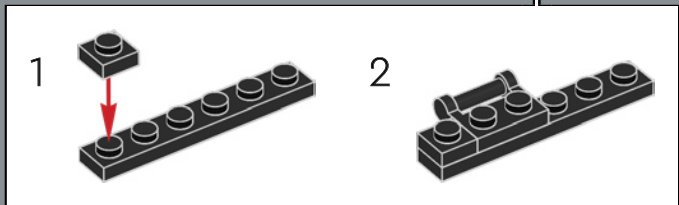
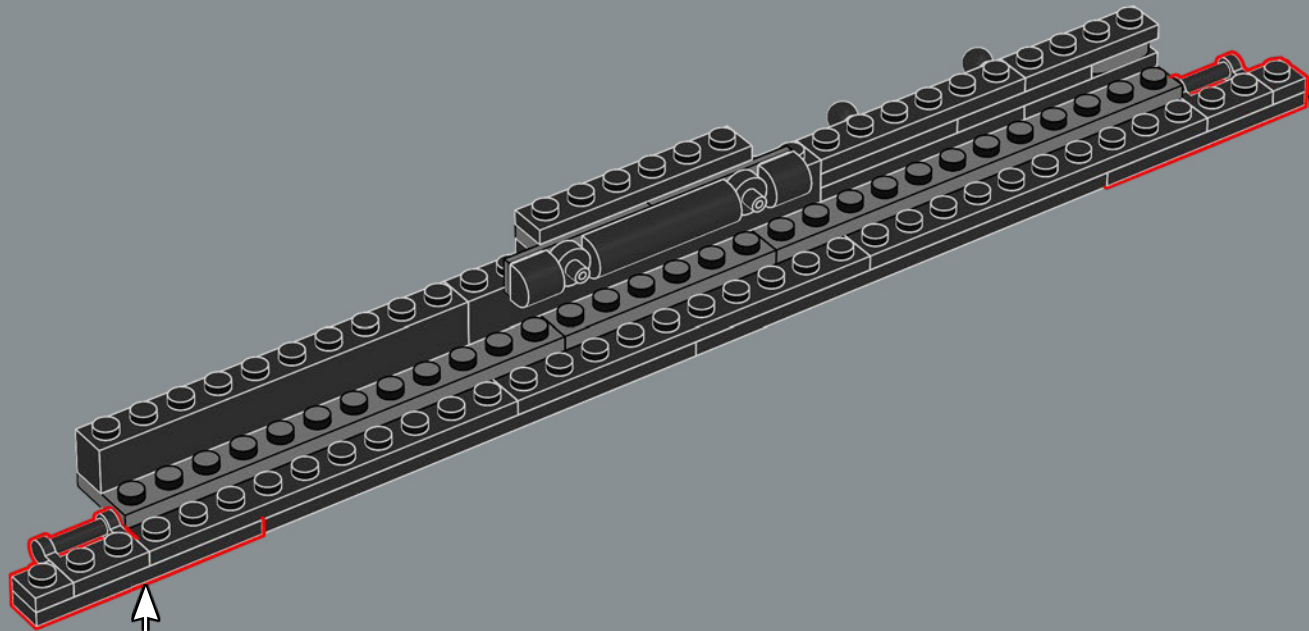
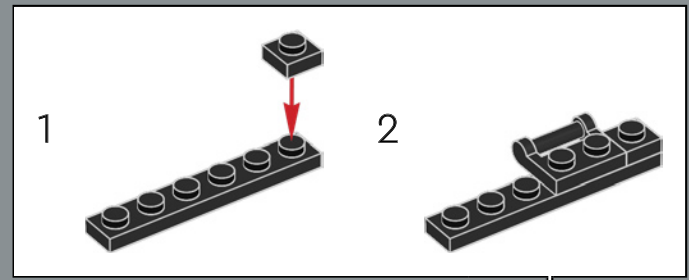

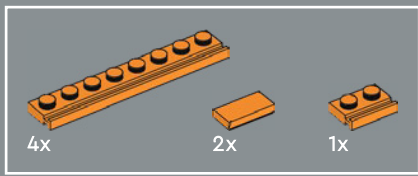

234

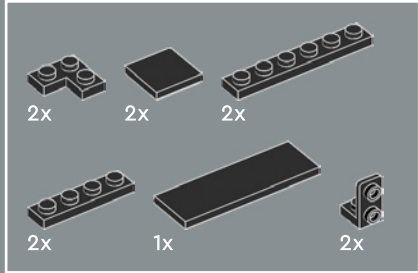
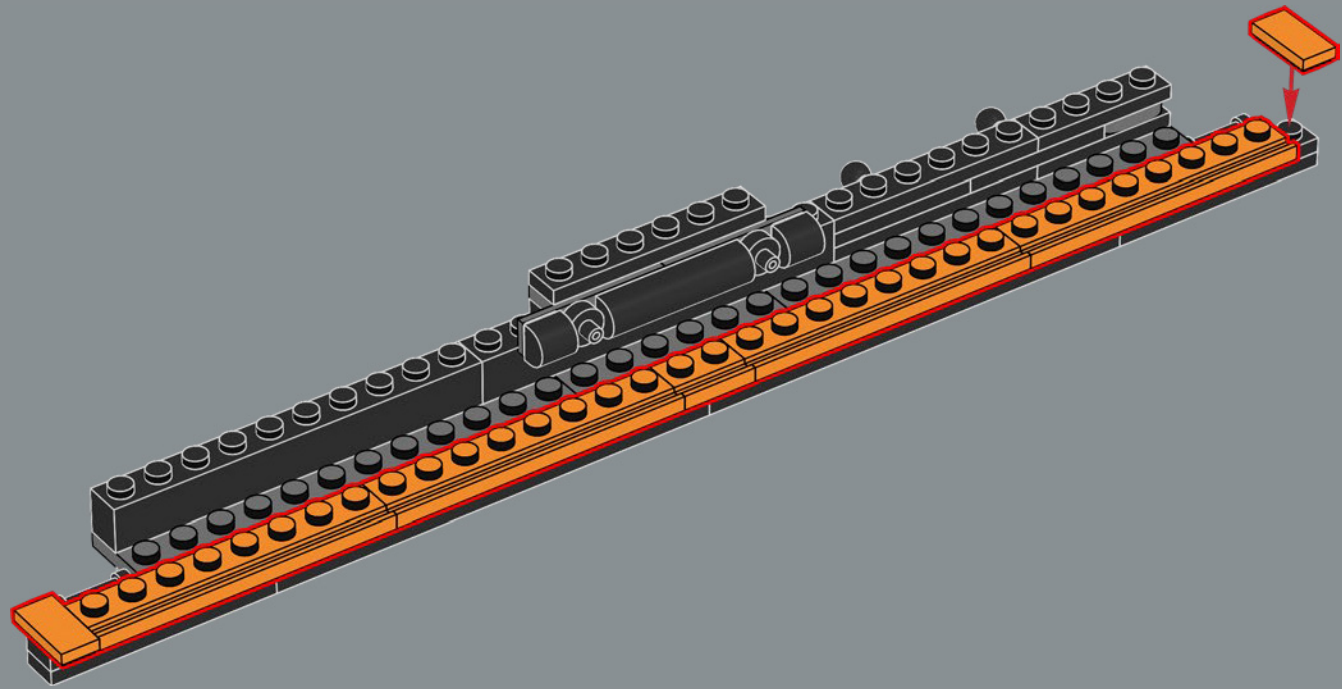

235

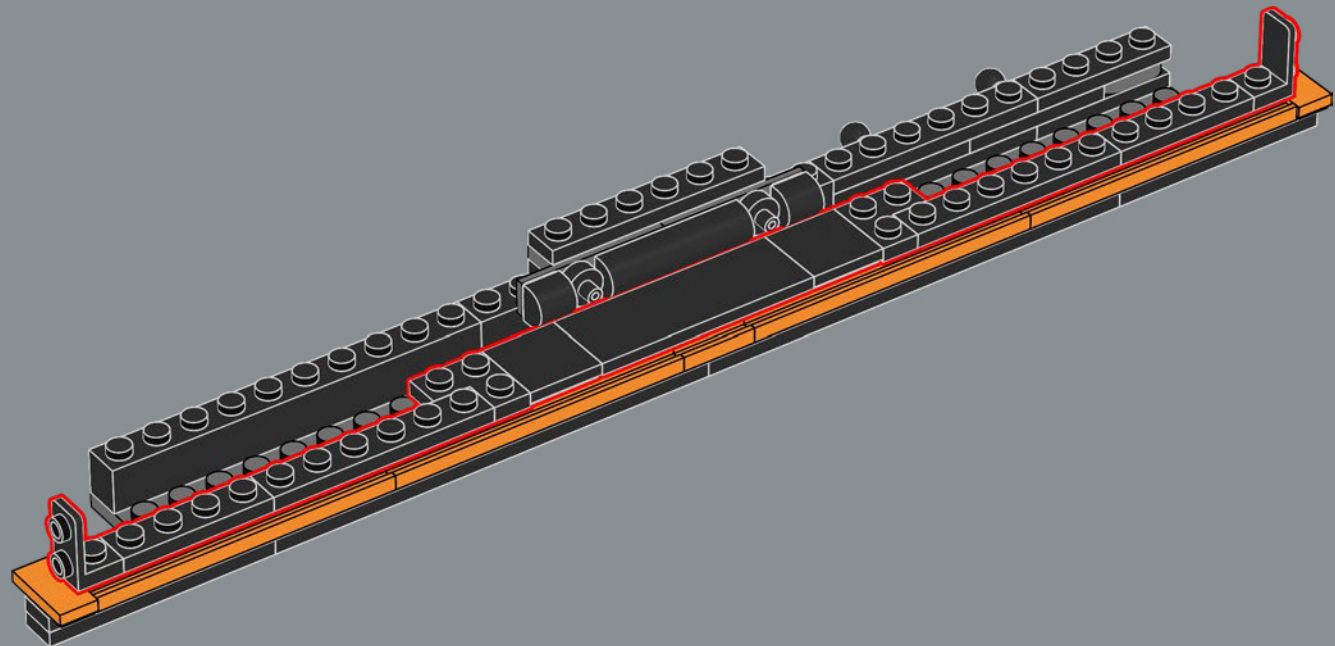

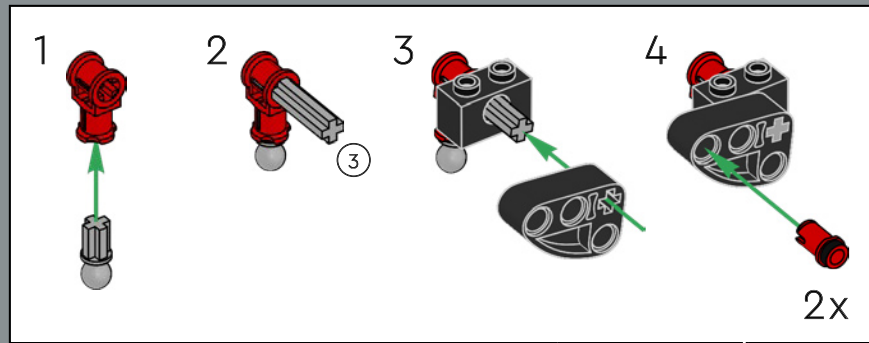
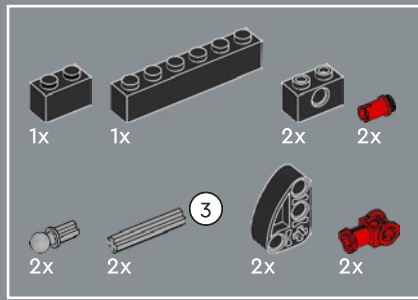

236

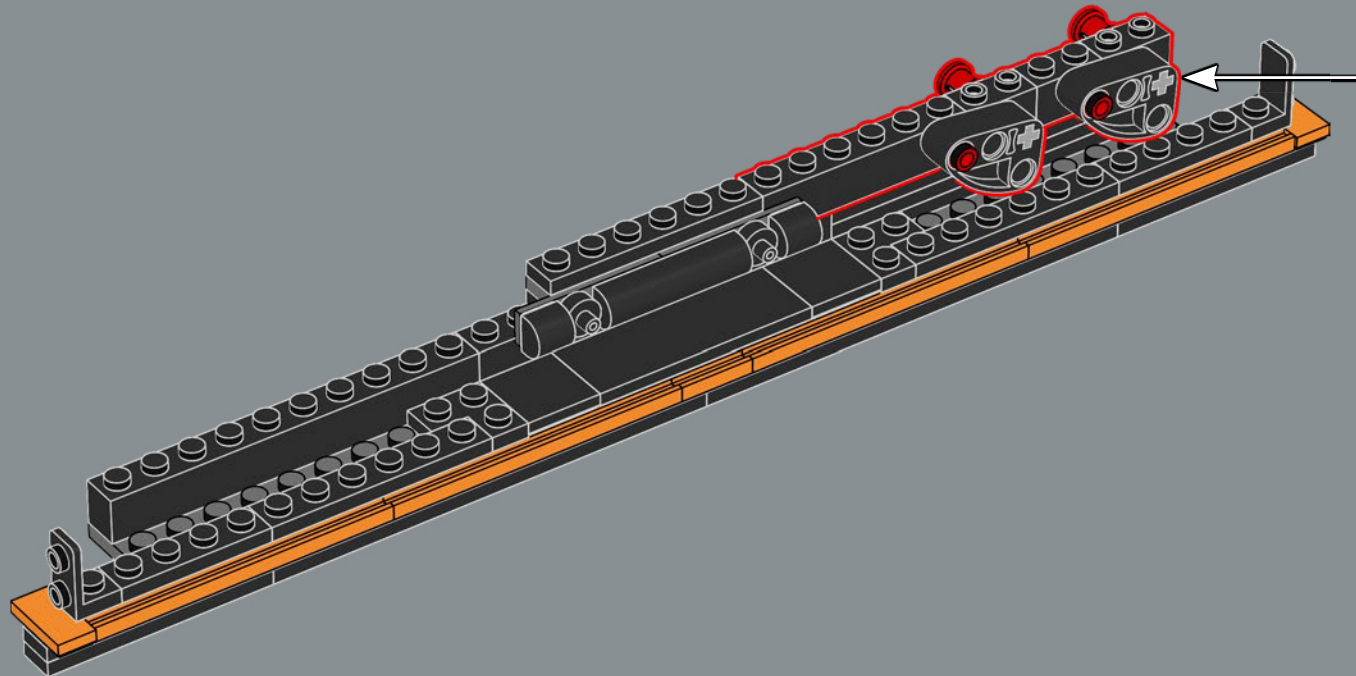

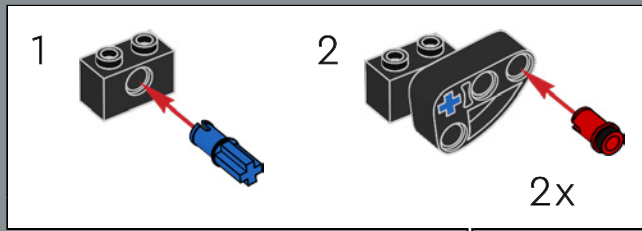
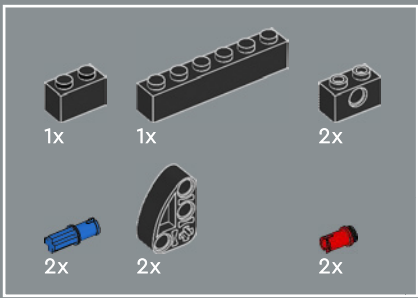

237

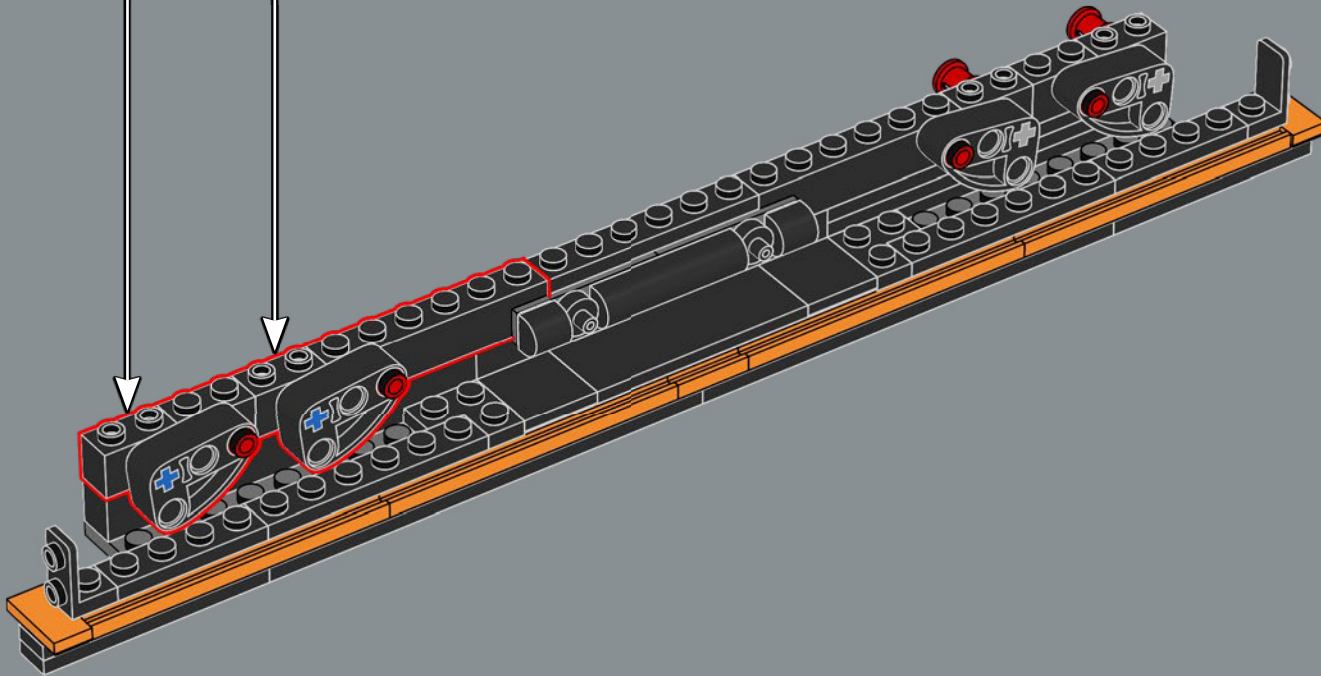

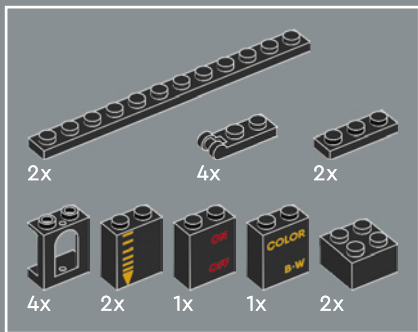

239

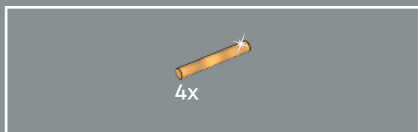
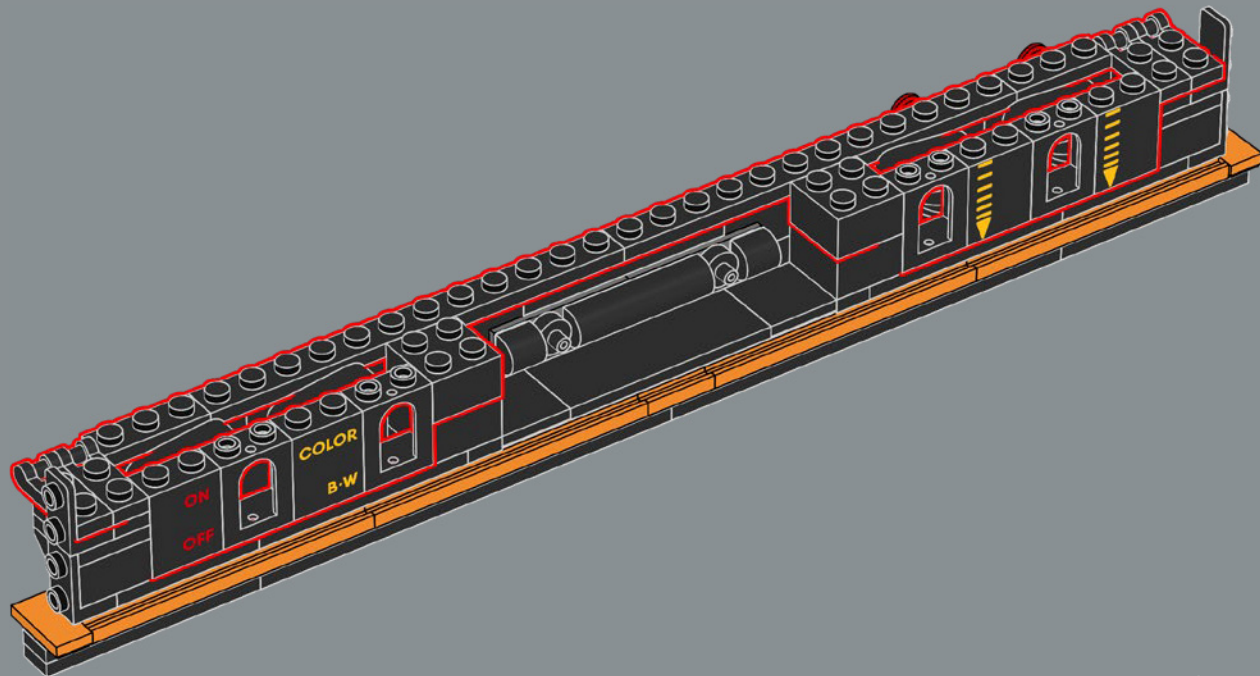

240

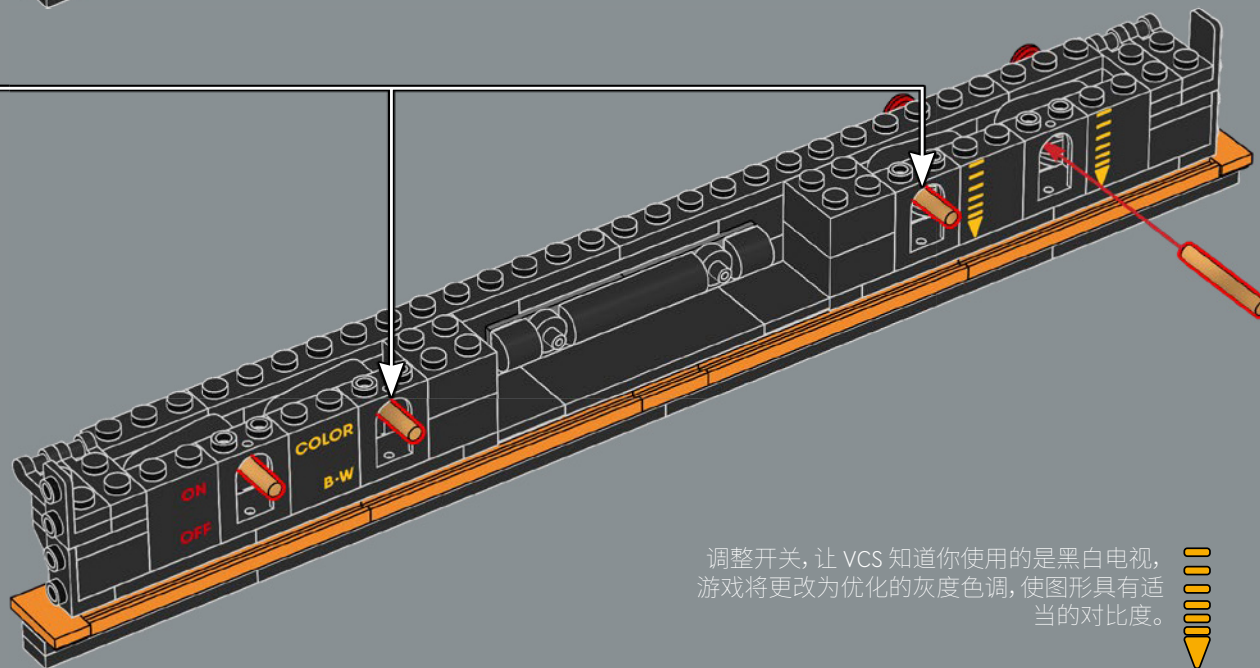
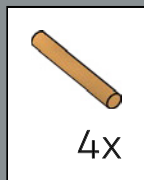

调整开关, 让 VCS 知道你使用的是黑白电视, 游戏将更改为优化的灰度色调, 使图形具有适当的对比度。



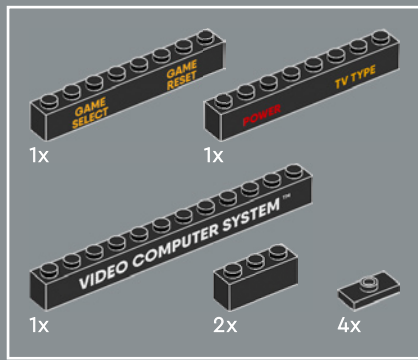

241

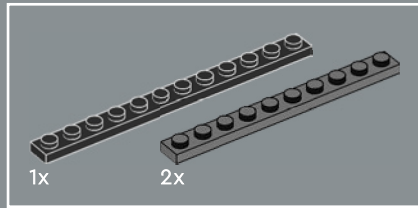
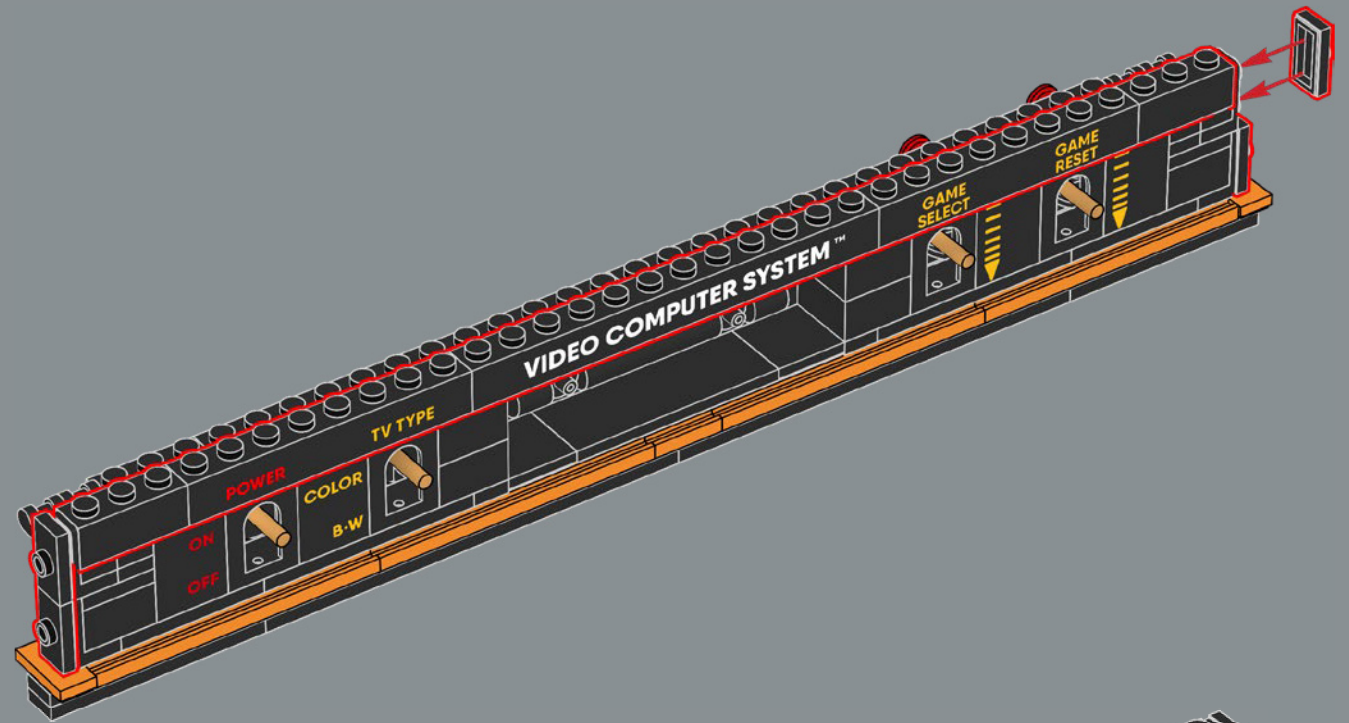

242

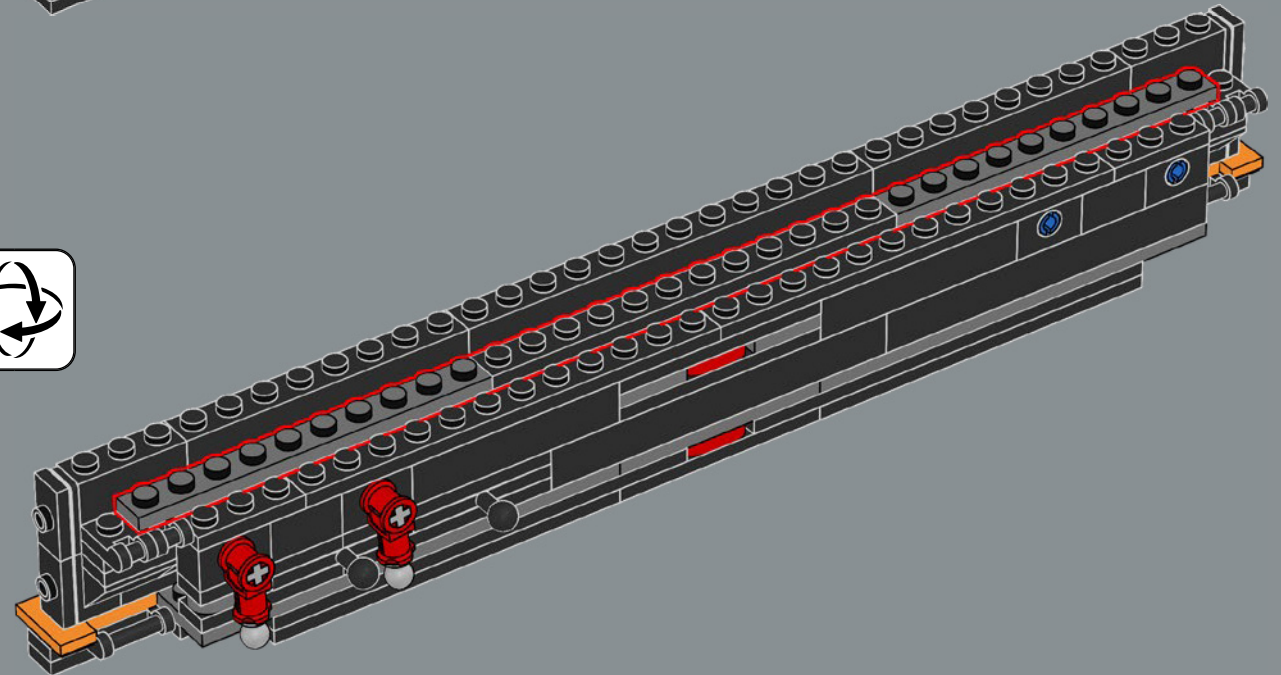

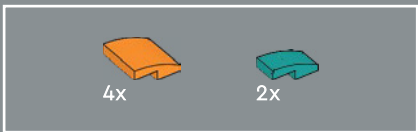

243

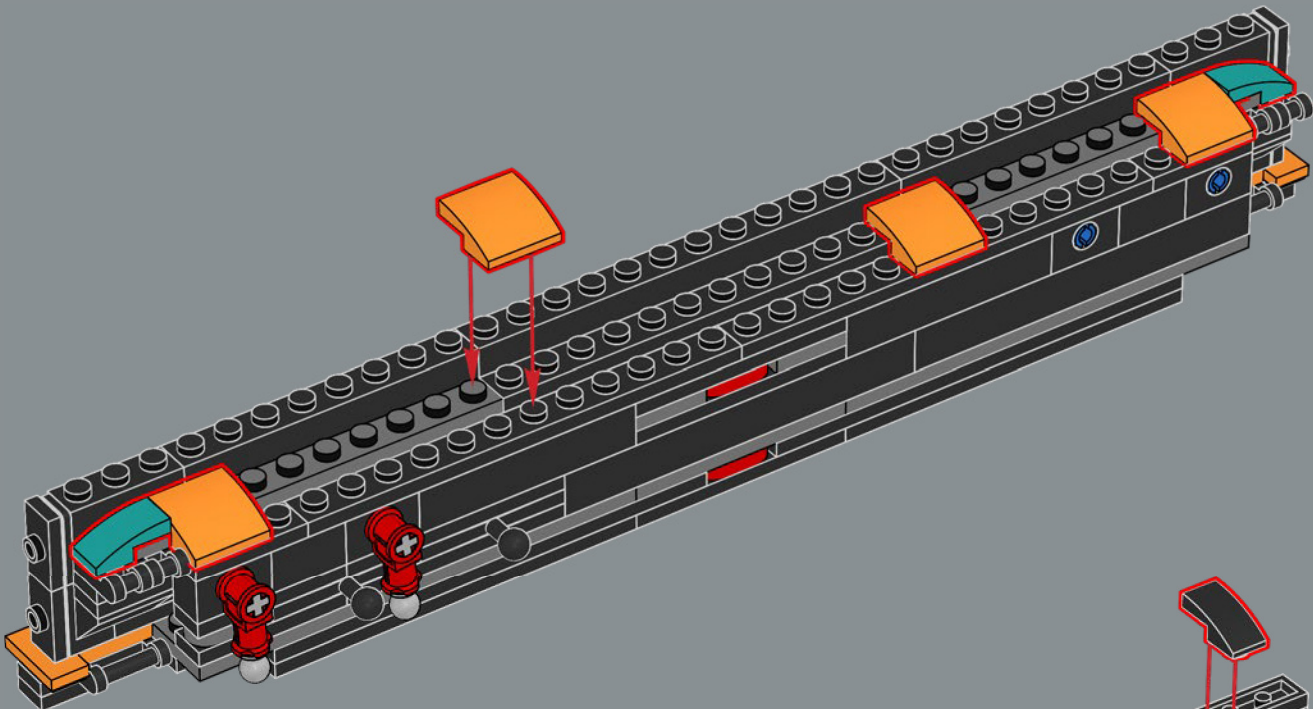

244



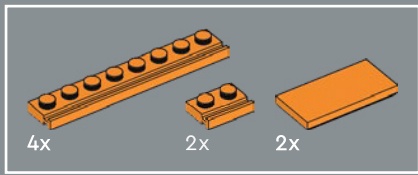

245

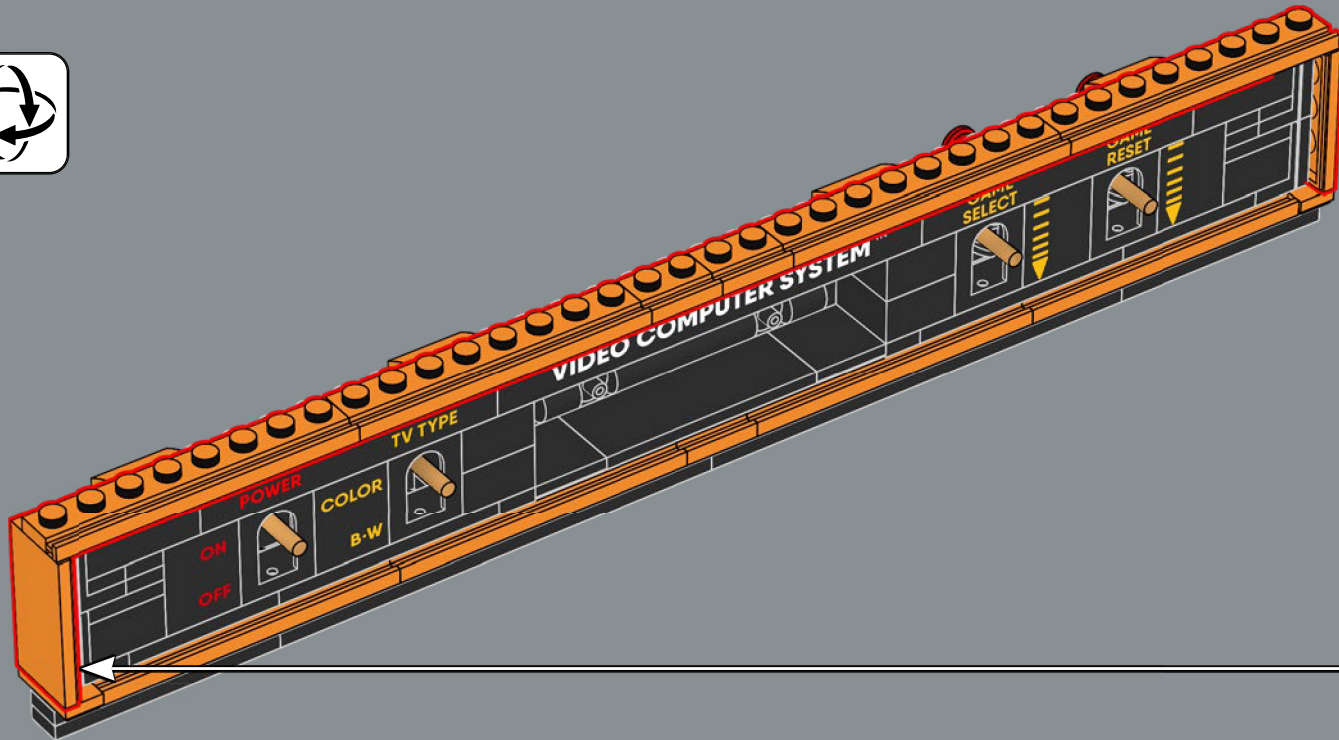
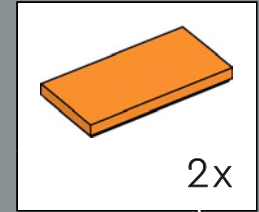



246

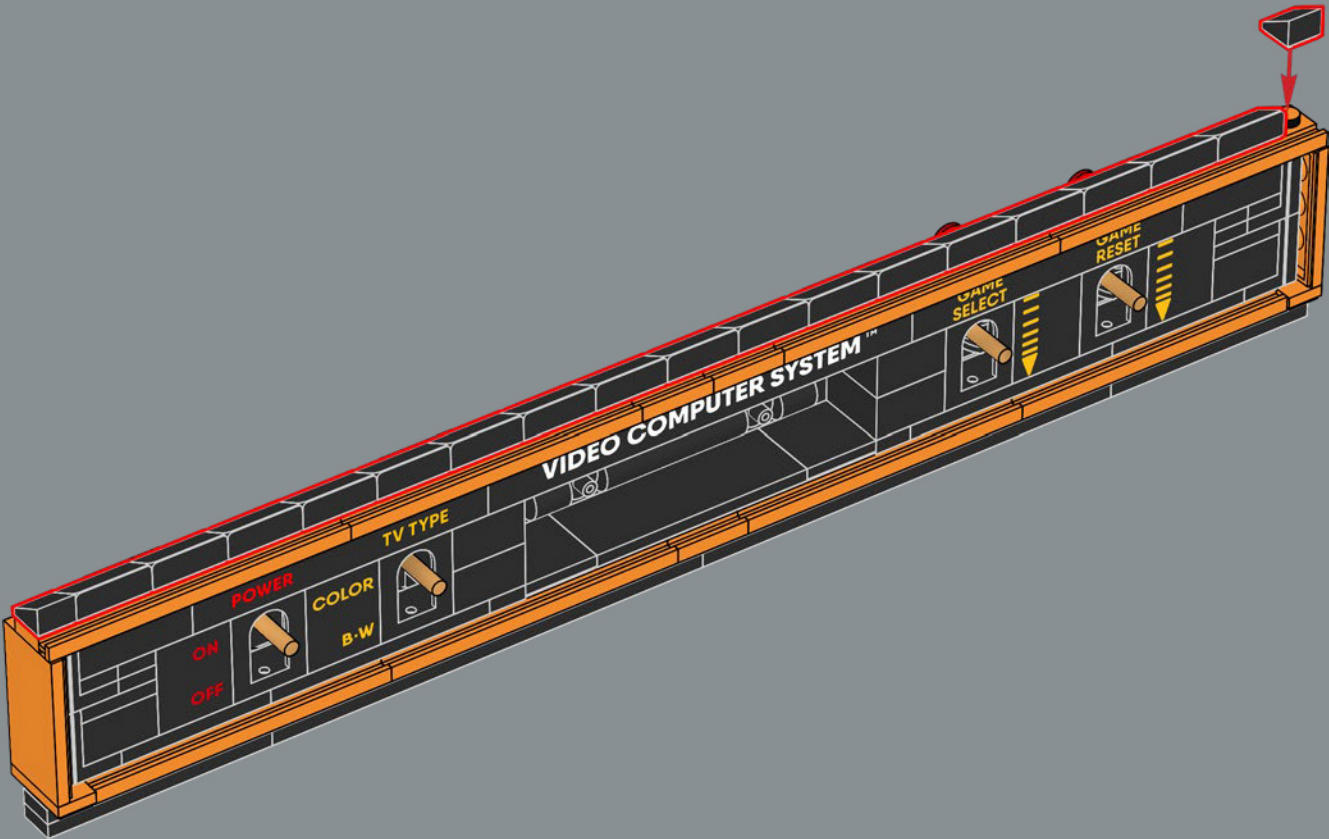



247

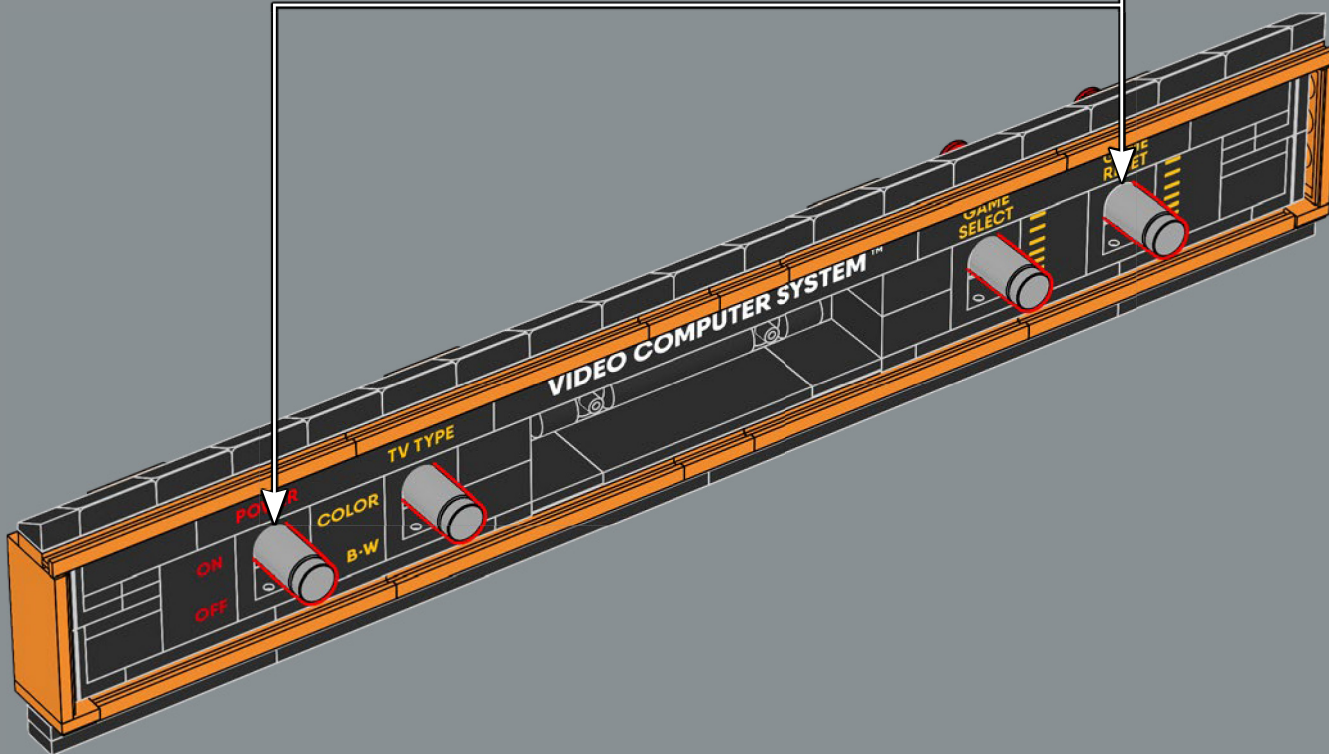
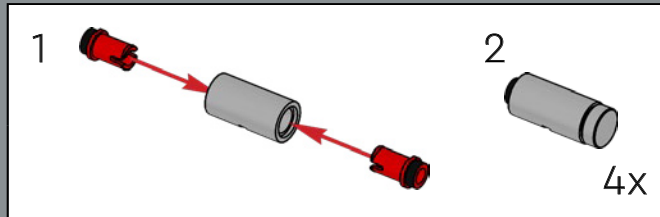



2x



2x



2x



2x



4x



2x



4x



4x



4x

248

1

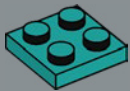

2

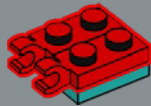

3

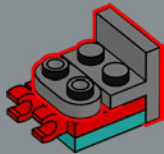

4

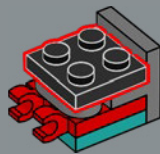

5

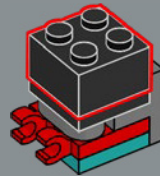

6

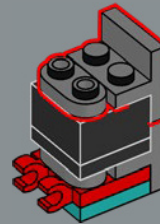

7

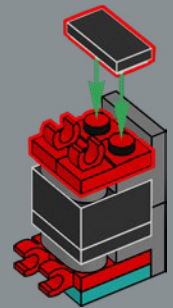

2x

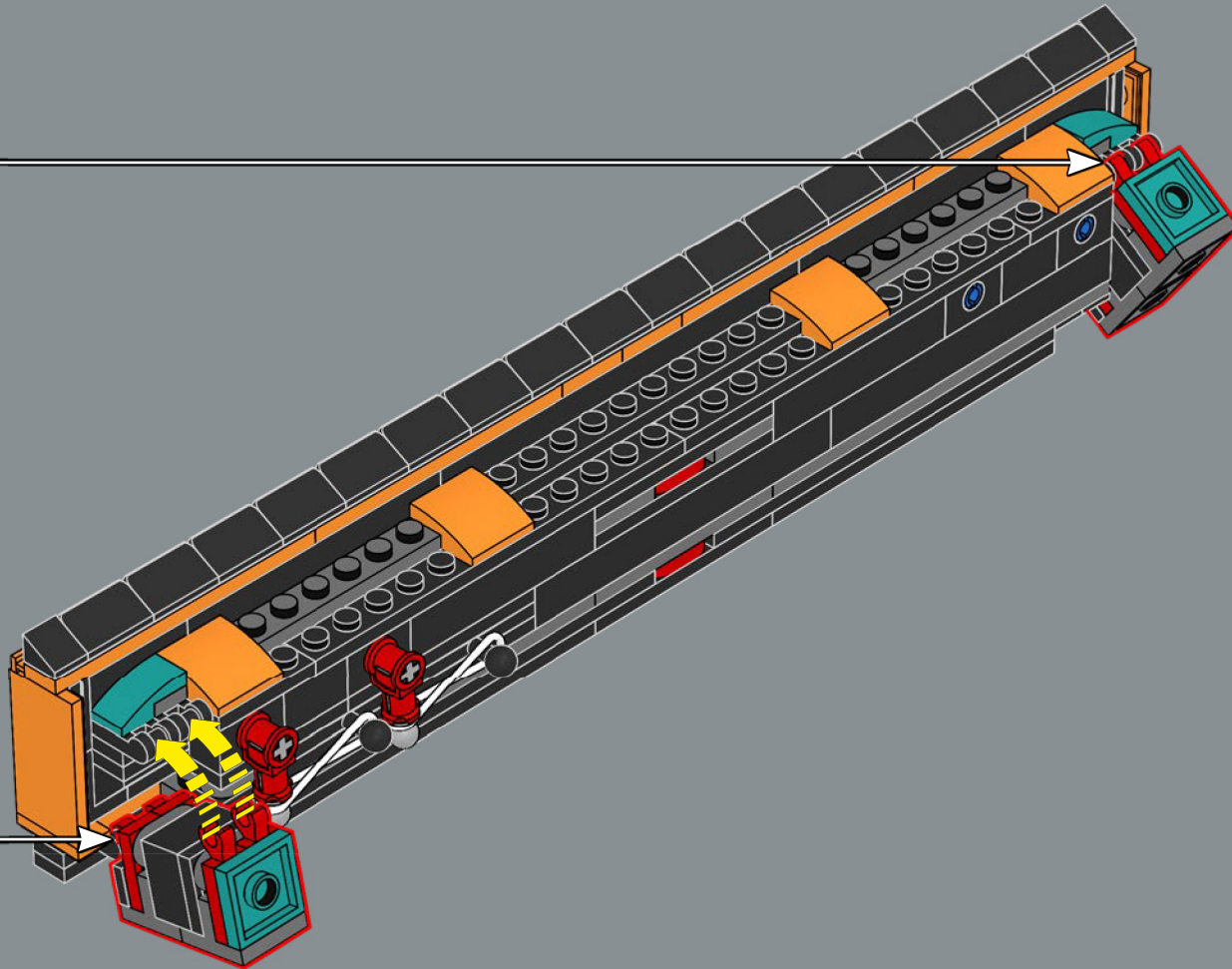

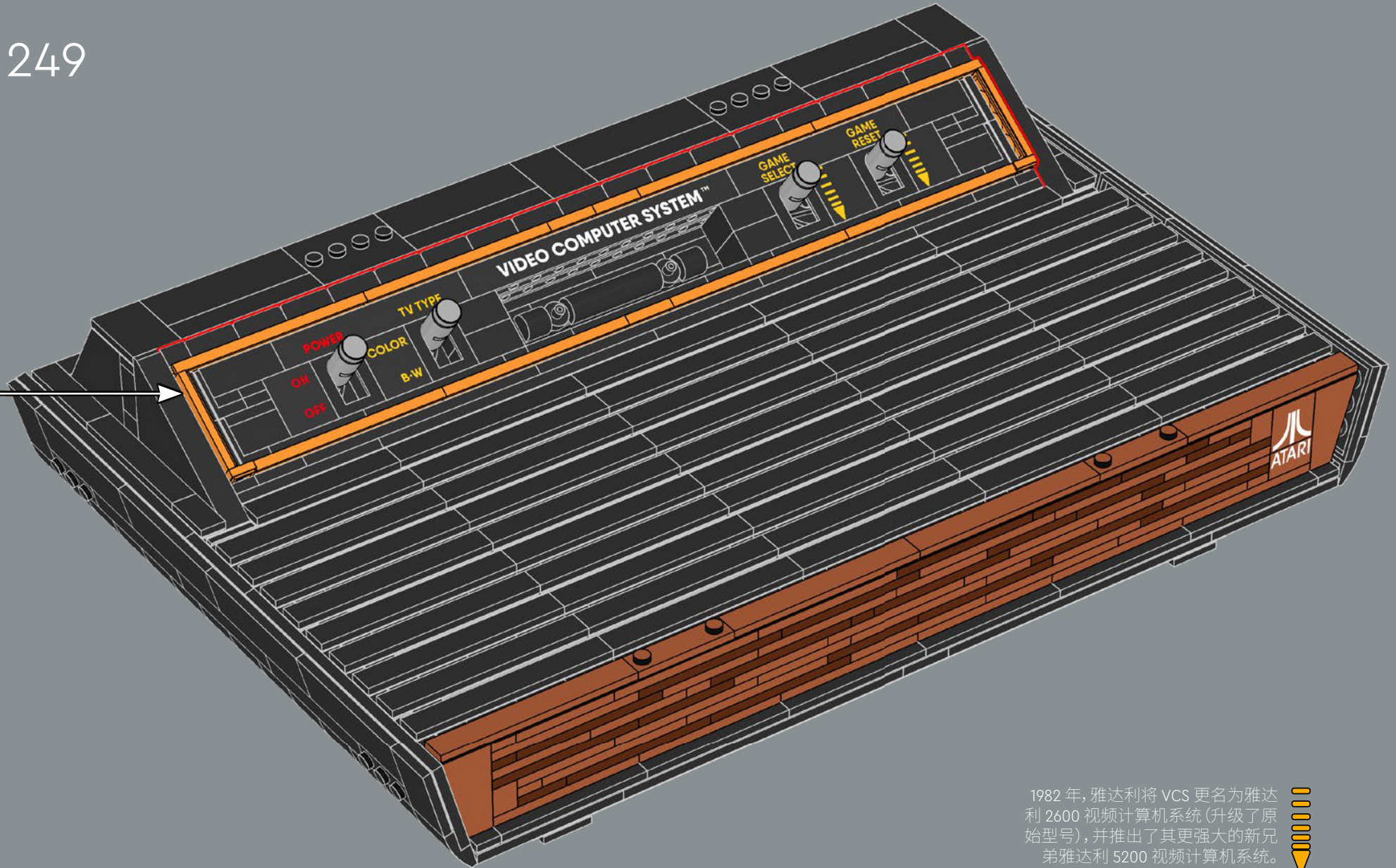

1982年，雅达利将VCS更名为雅达利2600视频计算机系统（升级了原始型号），并推出了其更强大的新兄弟雅达利5200视频计算机系统。



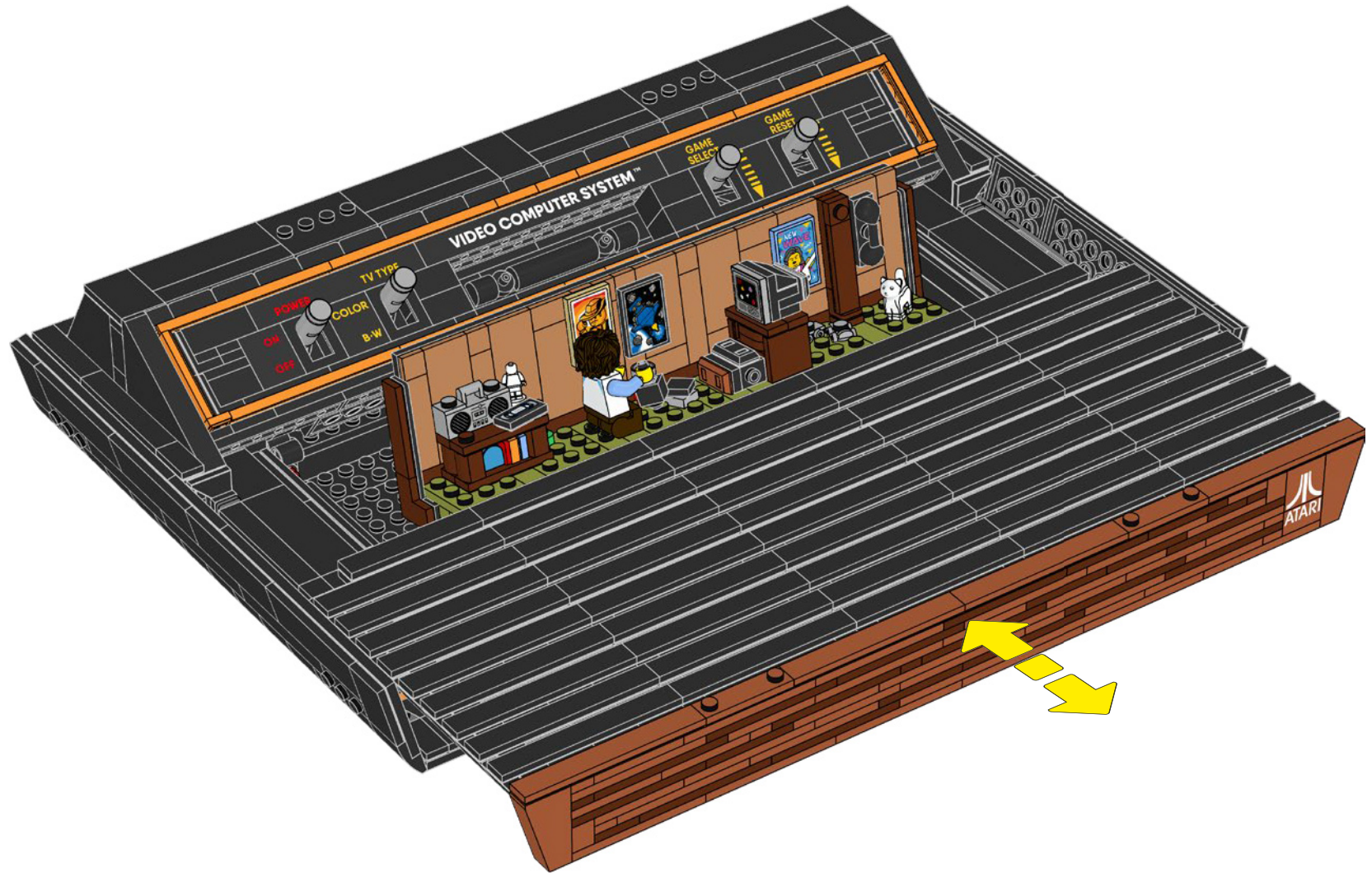

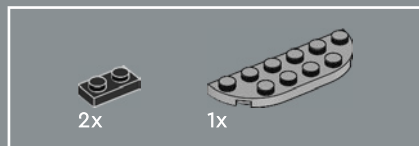
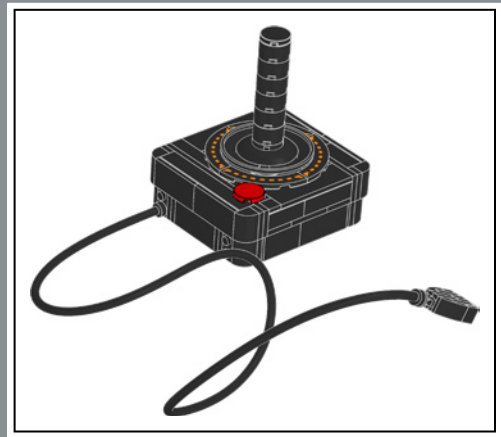
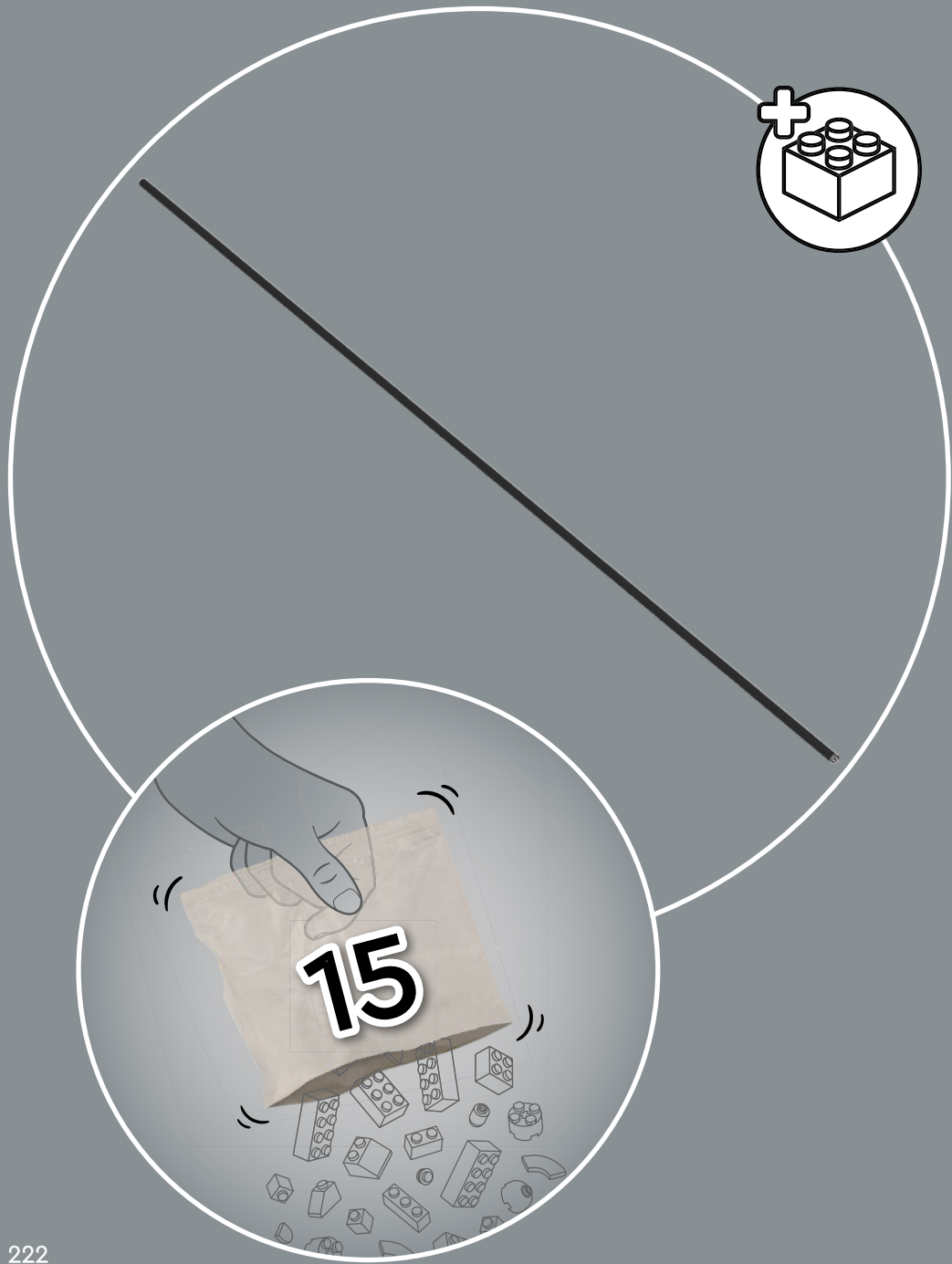

2x

1x

1

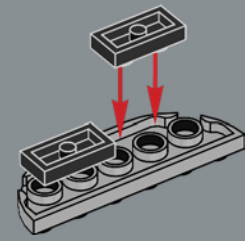

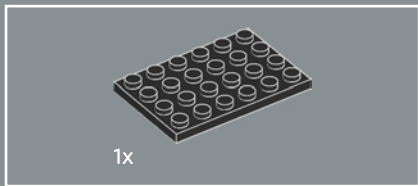

2

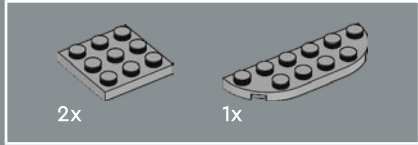
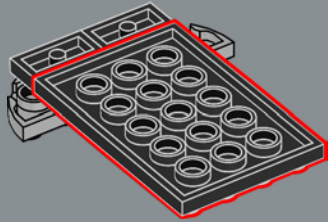

3

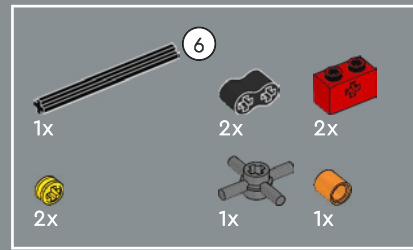
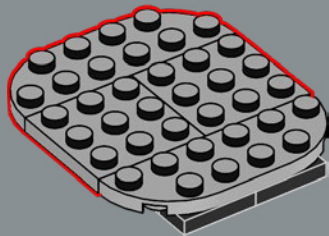

4

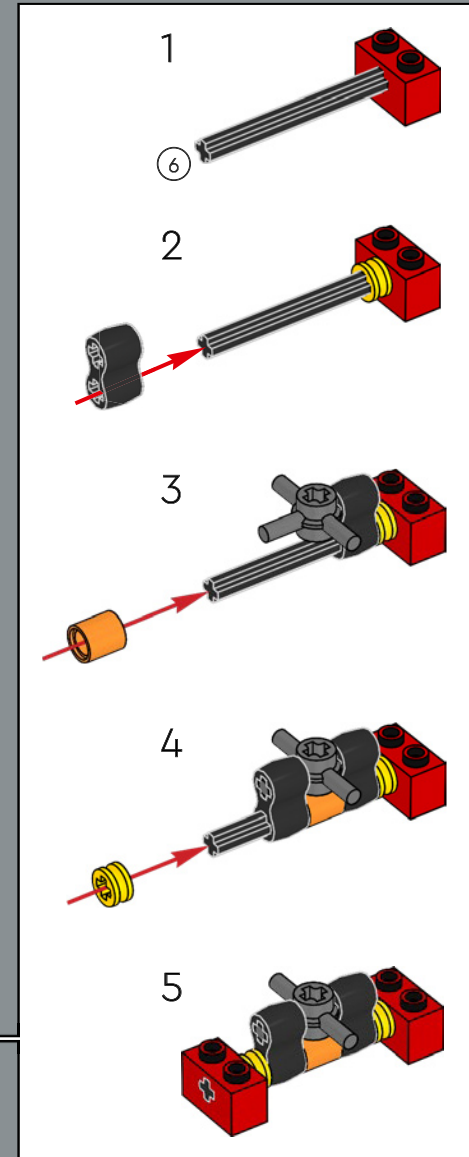
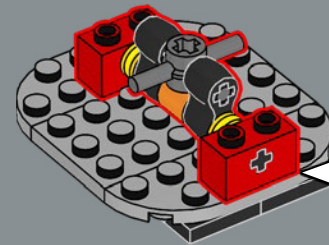

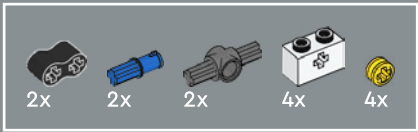

5

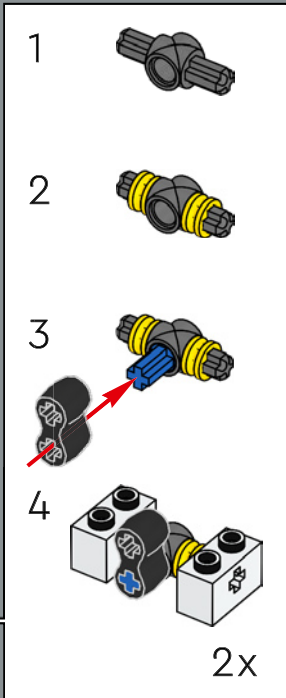
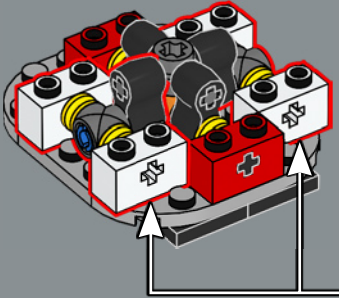

6

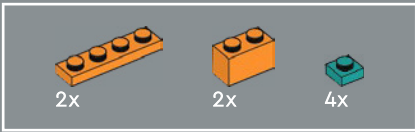
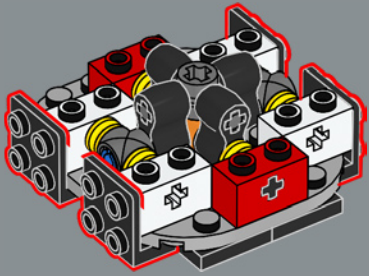

7

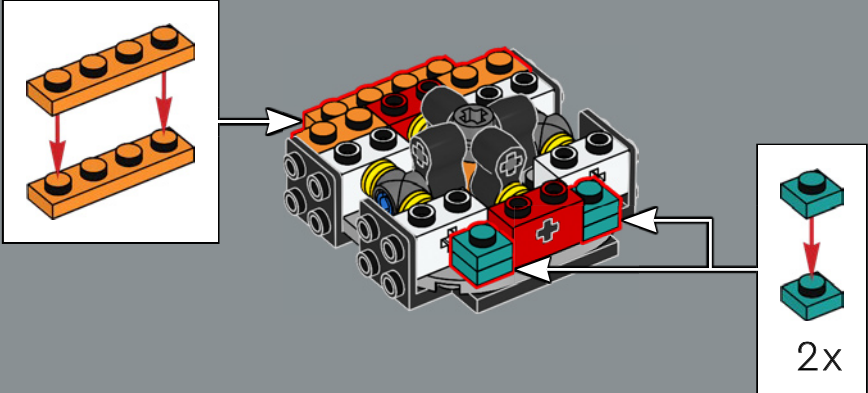

8

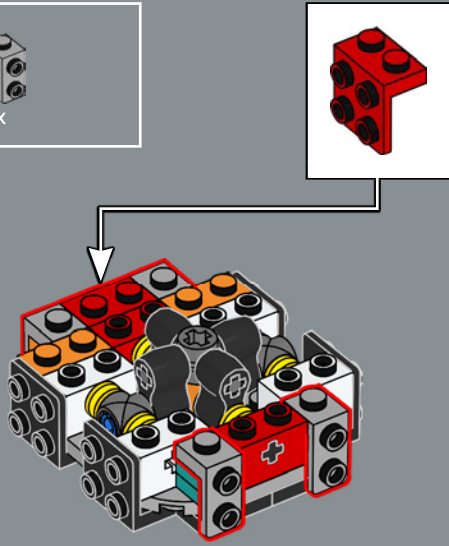

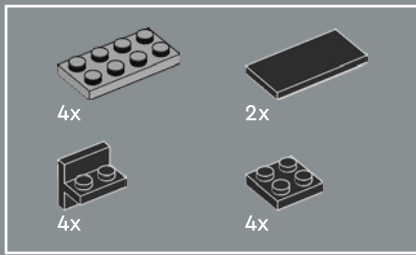

9

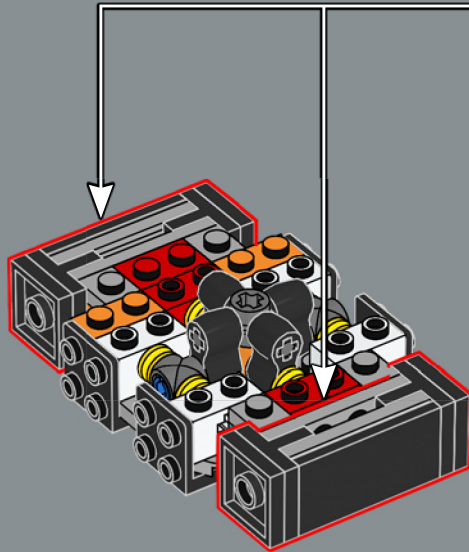
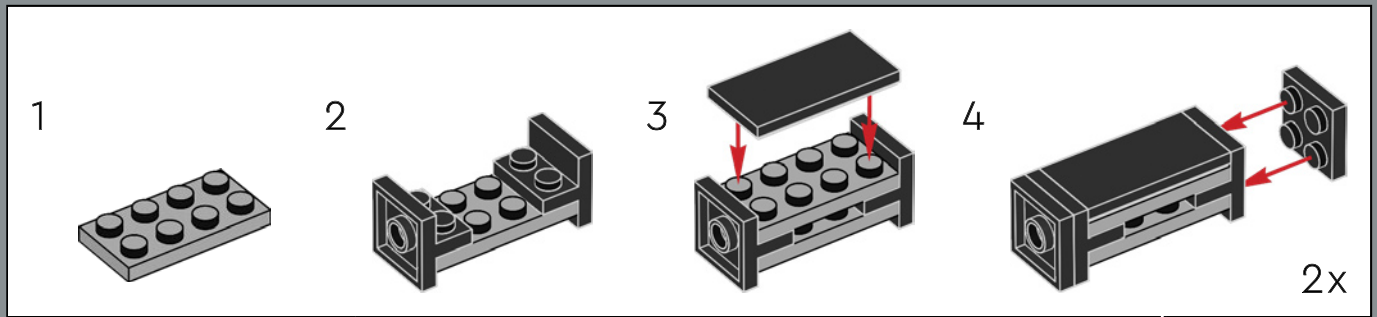

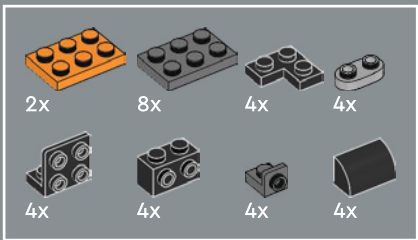

10

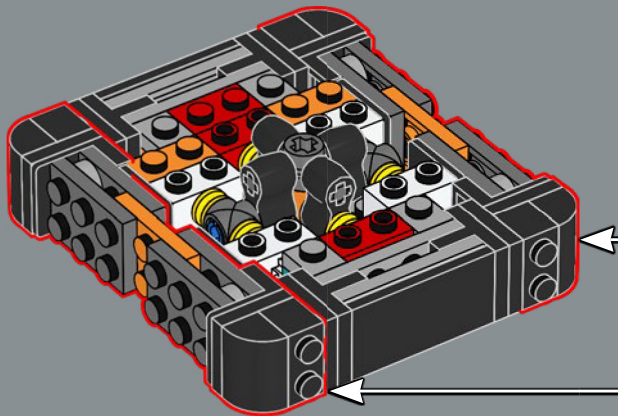
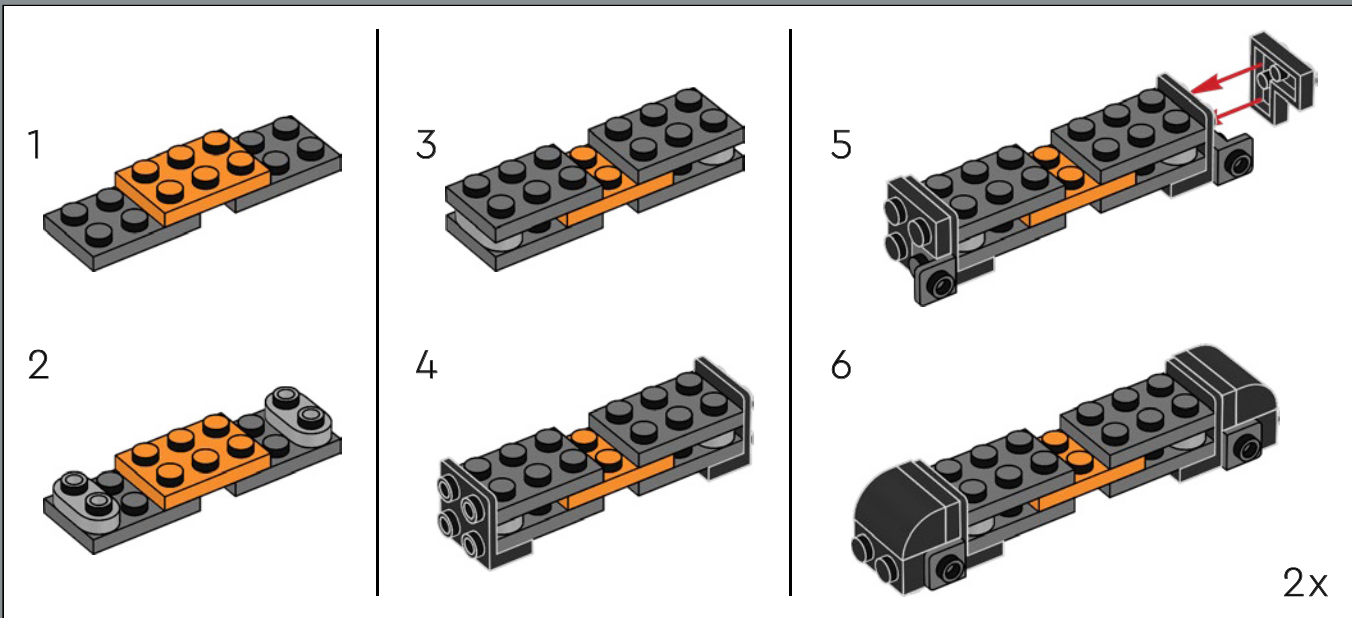

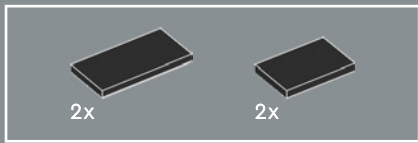

11

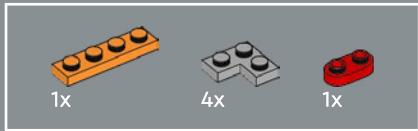
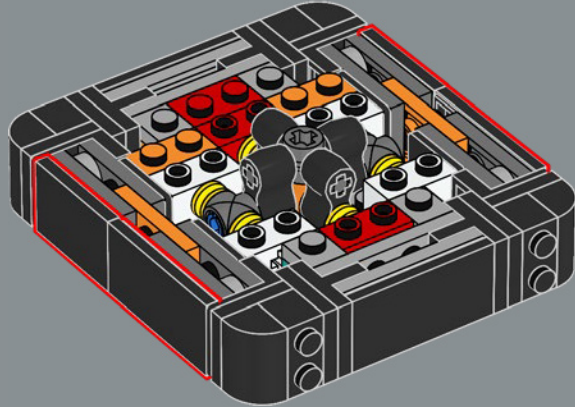

12

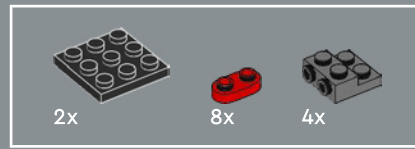
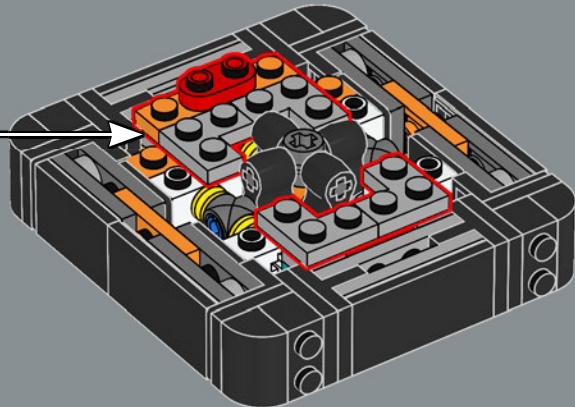
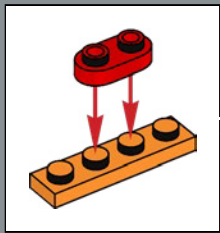

13

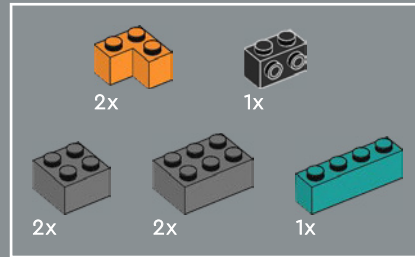
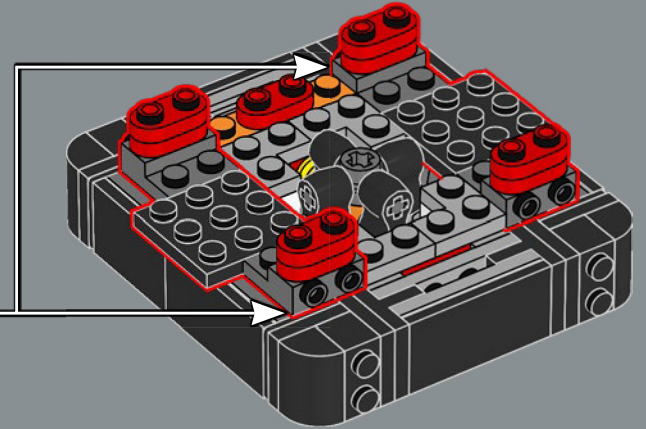
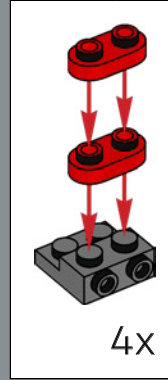

14

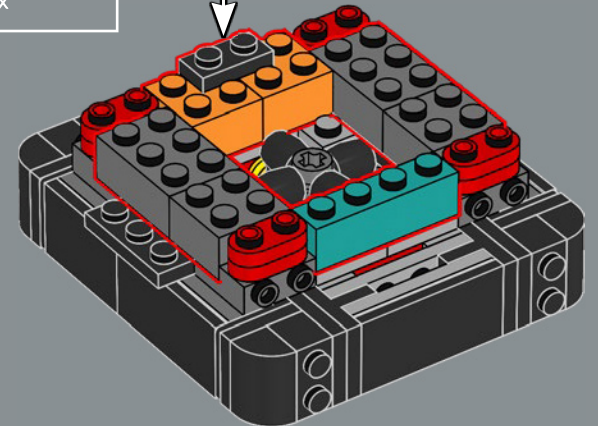
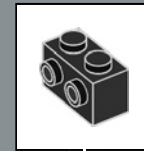

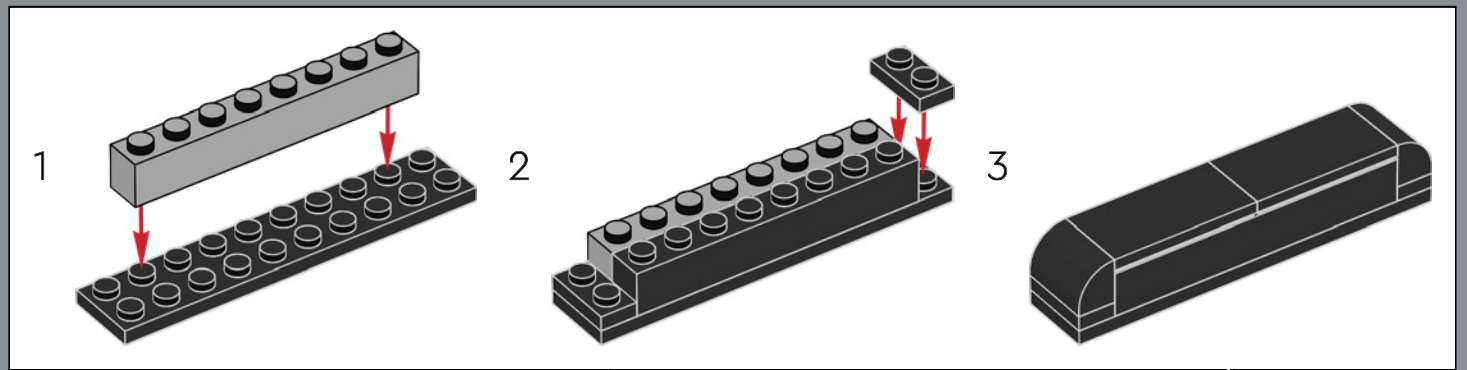
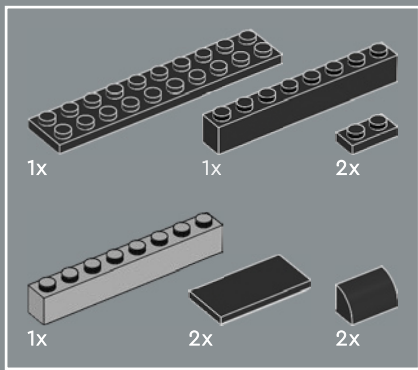

15

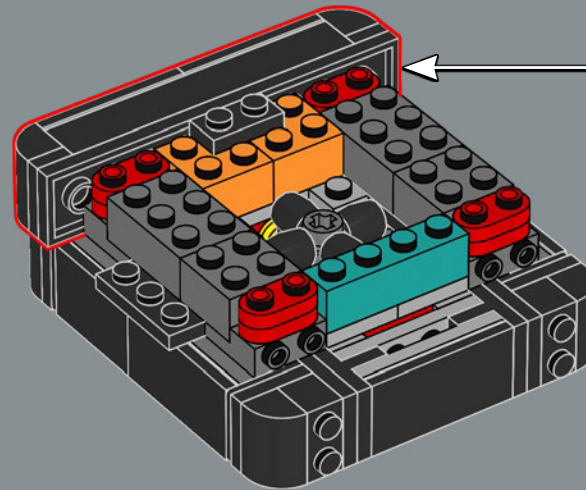

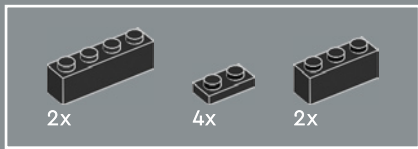

16

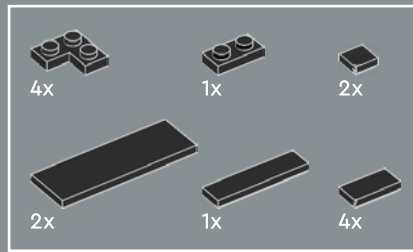
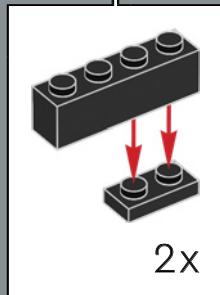
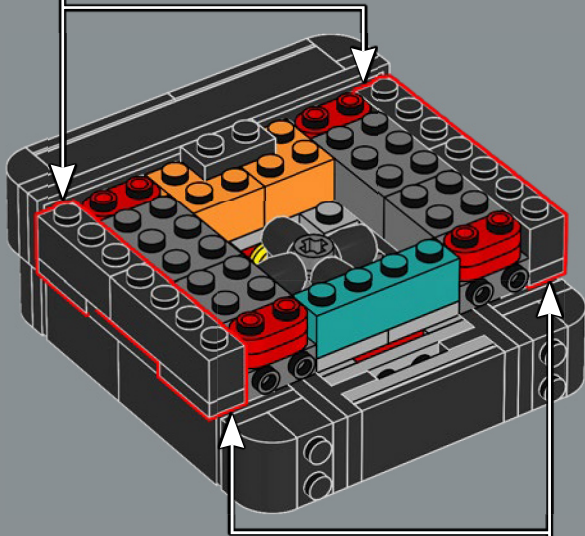
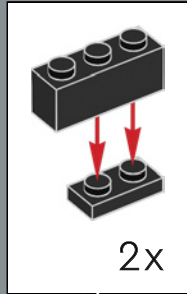

17

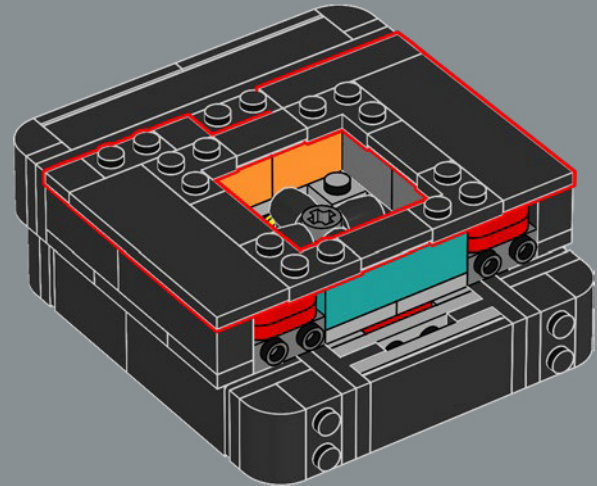

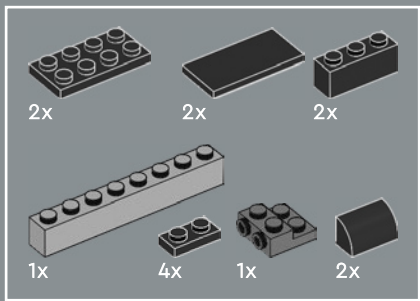

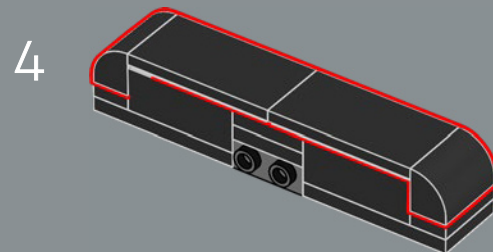
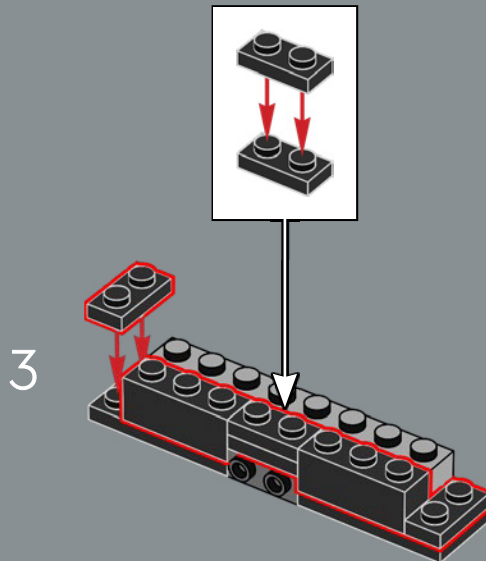
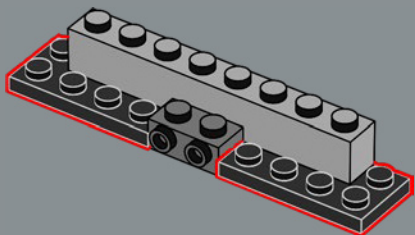
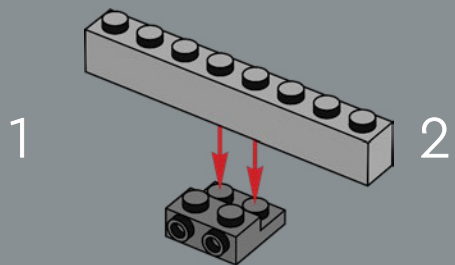

18

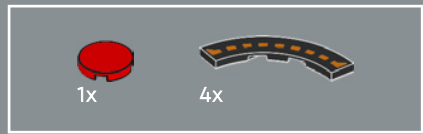

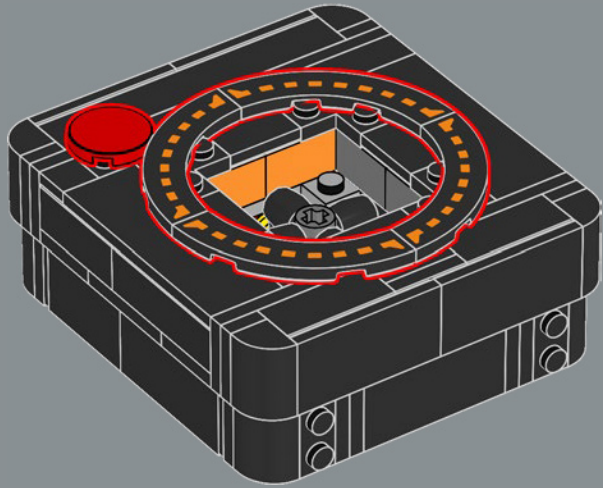
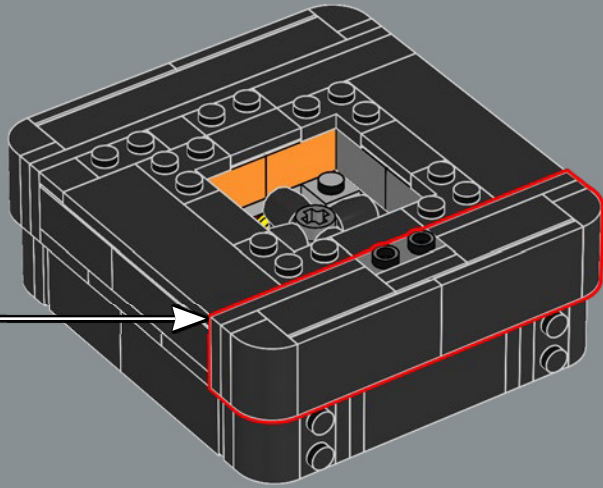

19



 雅达利视频计算机系统的摇杆如此具有标志性，以至于其外形和鲜红色按钮常被用于图标以代表游戏。

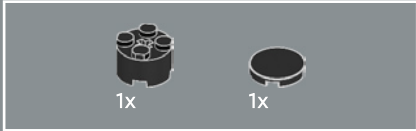
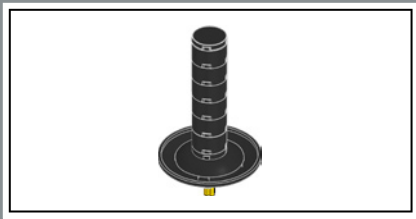

20

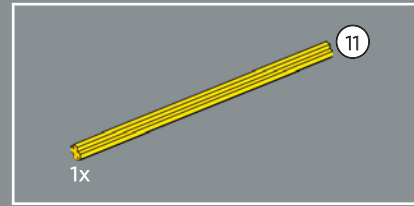
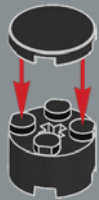

21



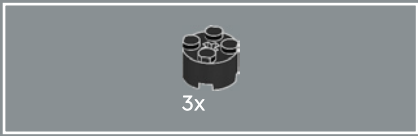

22

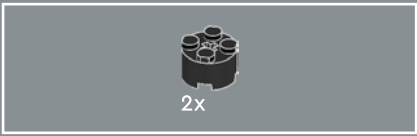
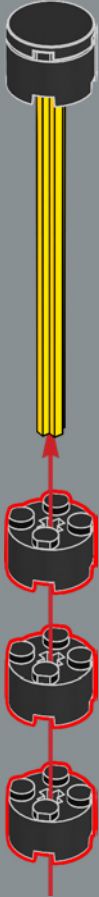

23

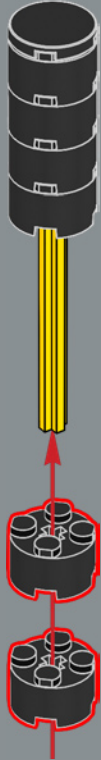

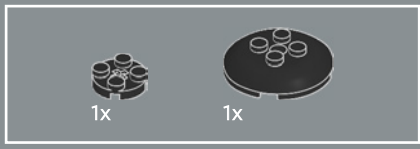

24

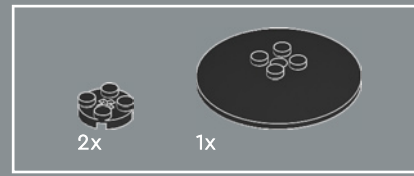
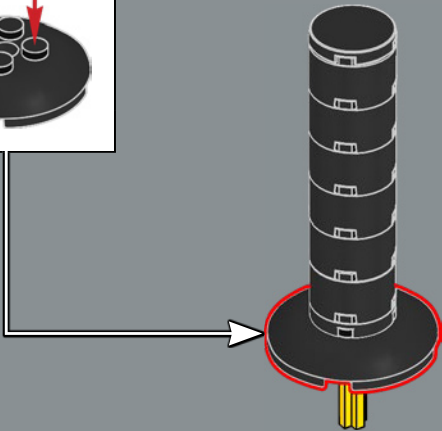
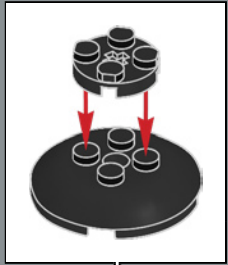

25

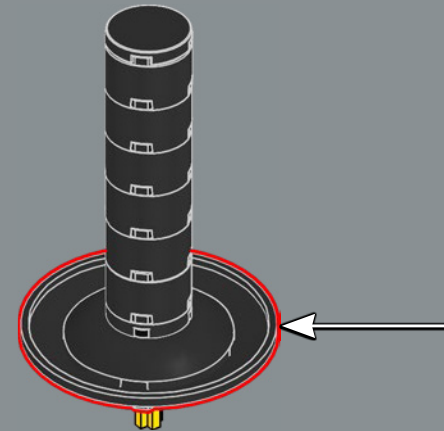
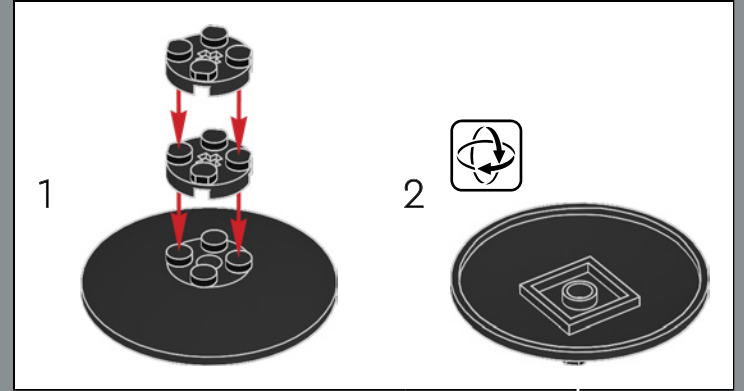

26

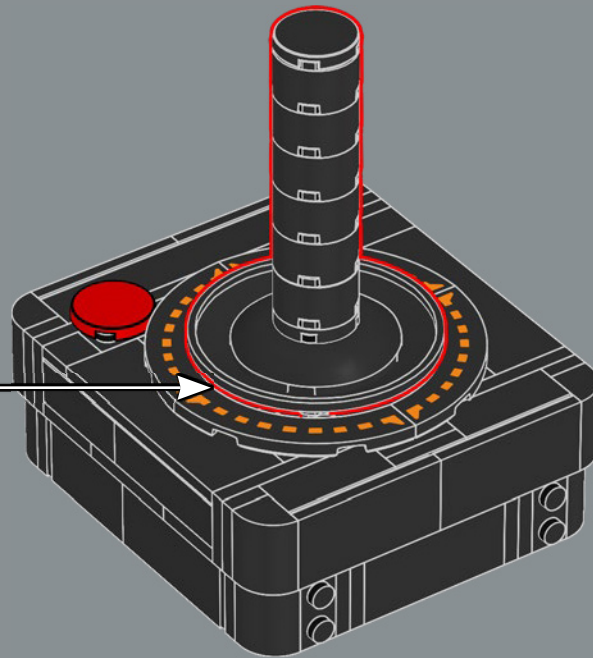

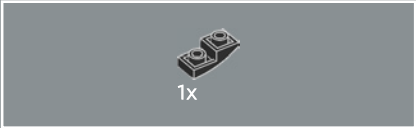
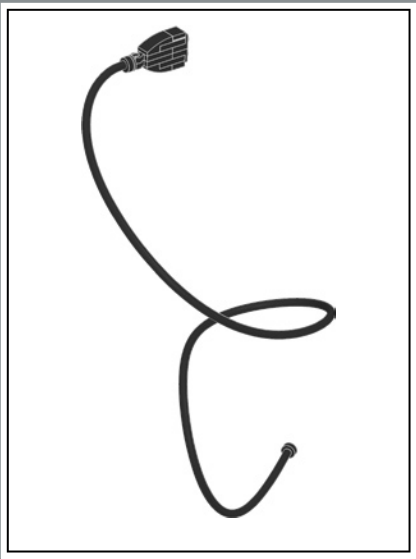

27

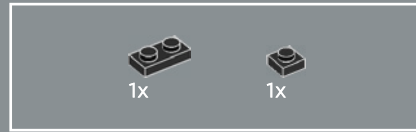
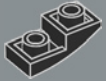

28

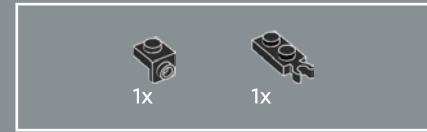
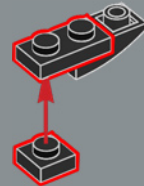

29

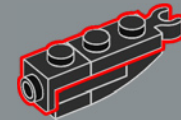



30

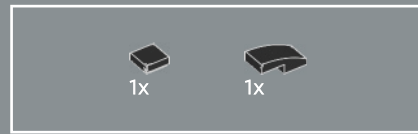
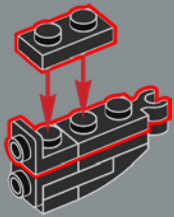

31

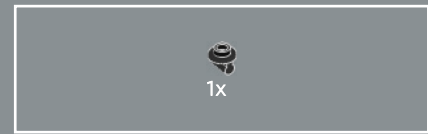
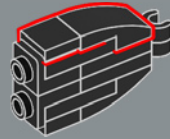

32

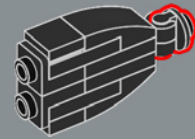



2x

33



2x

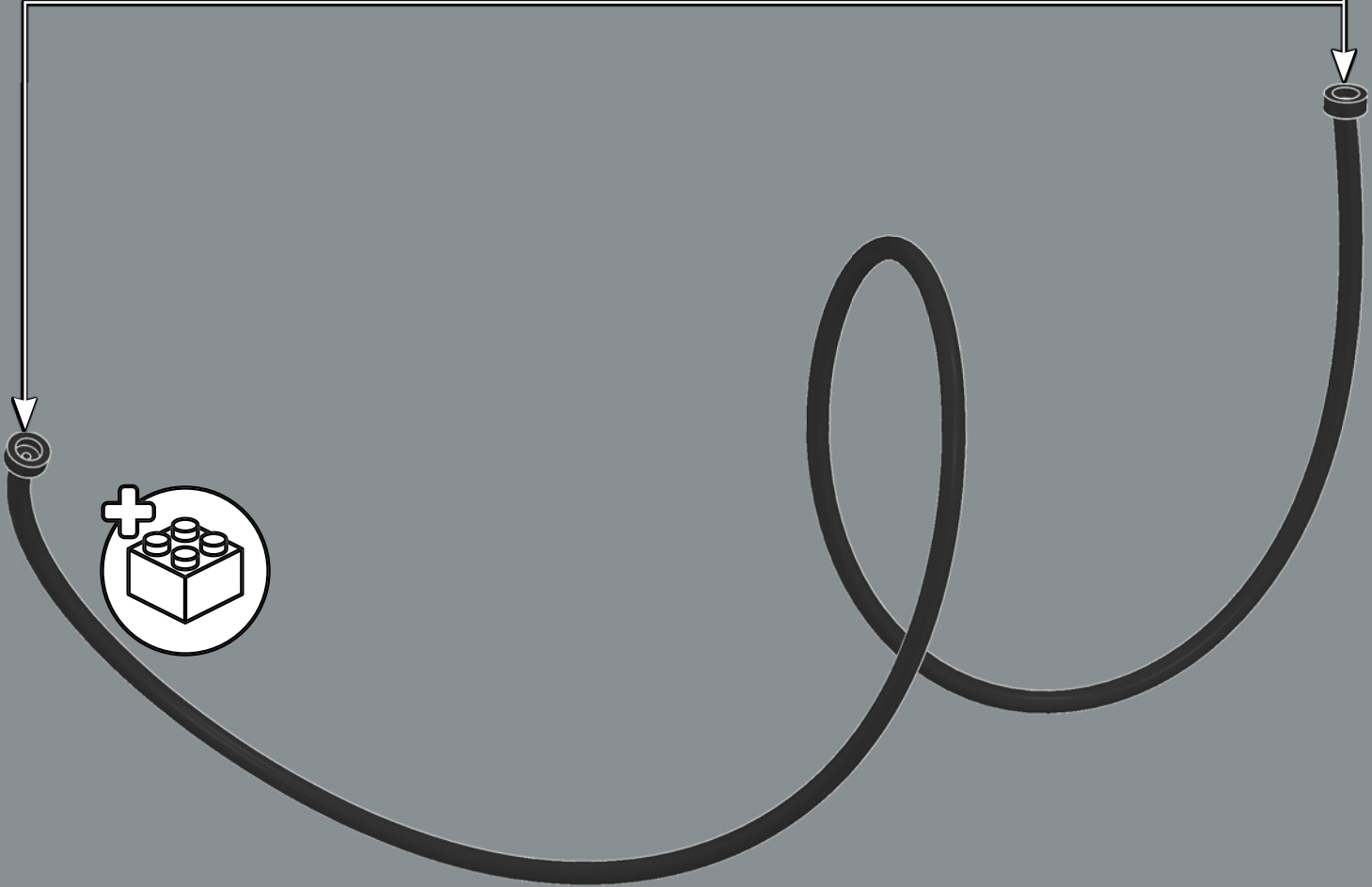

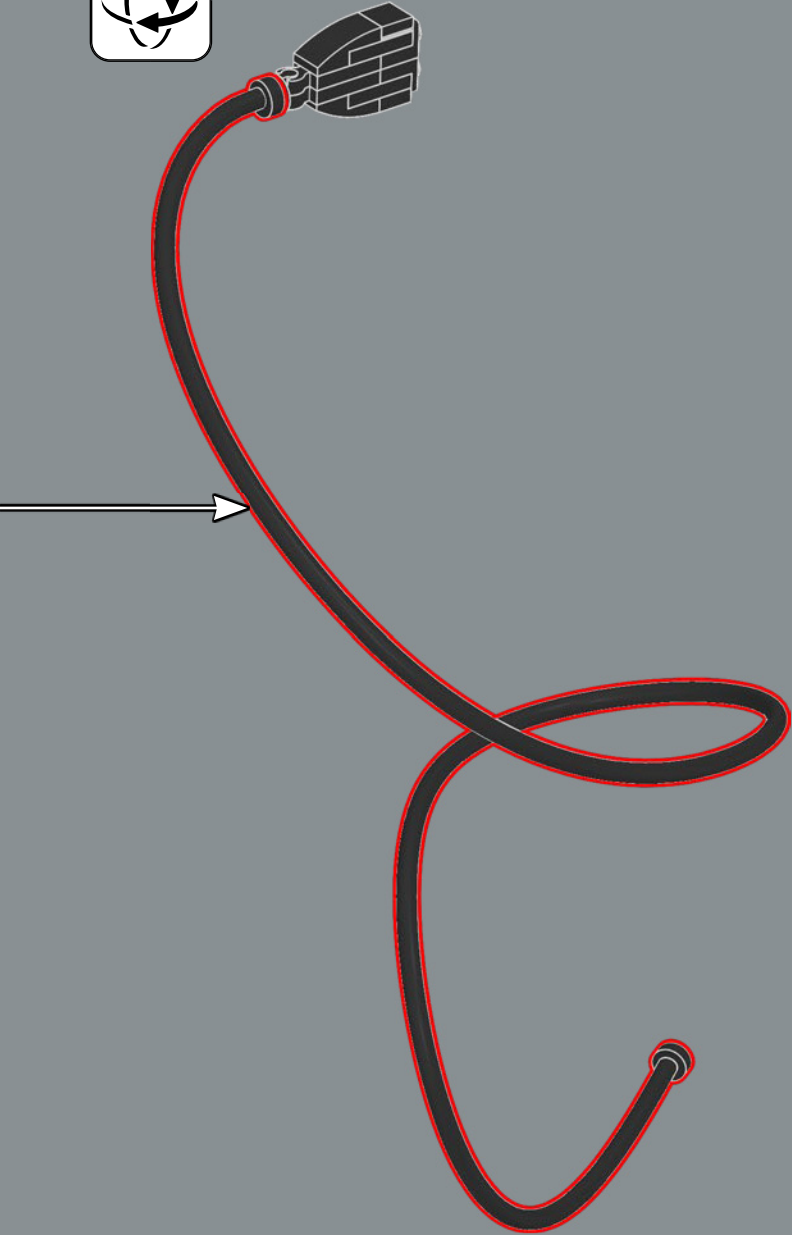

34

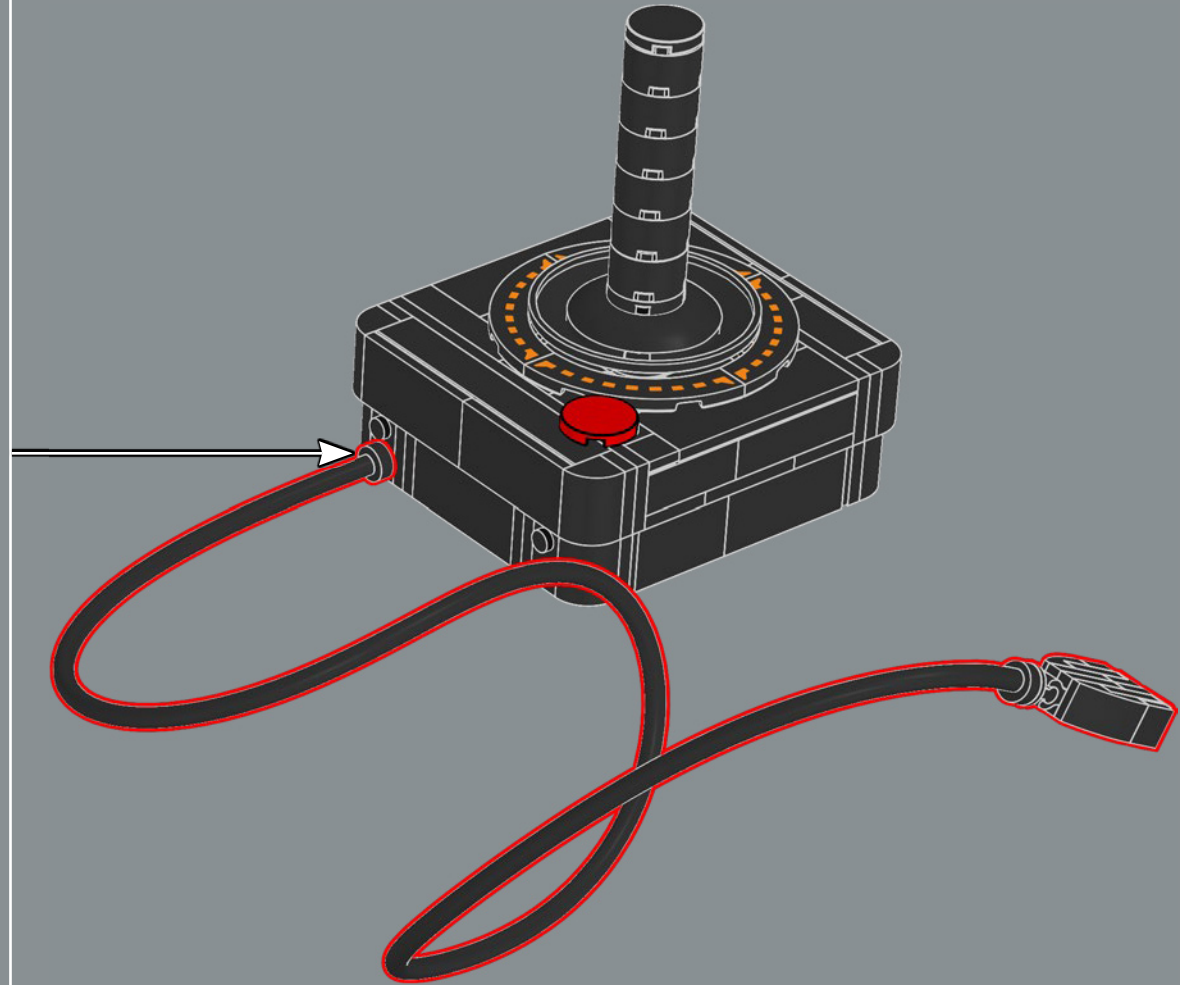

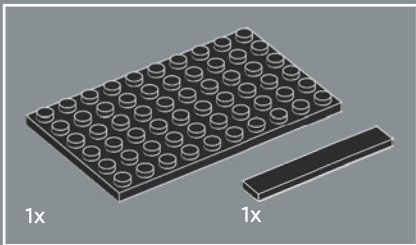

1

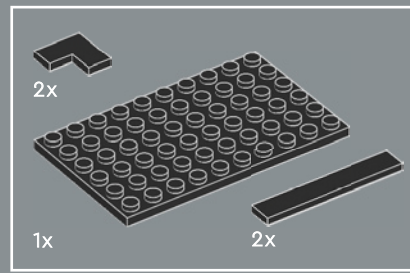
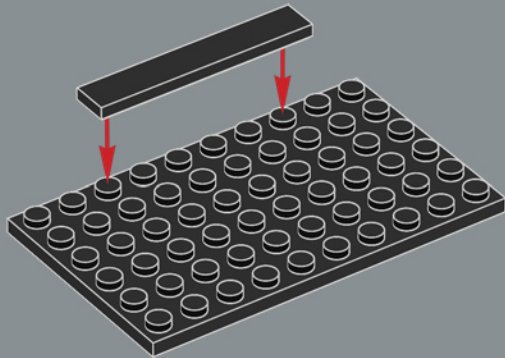

2

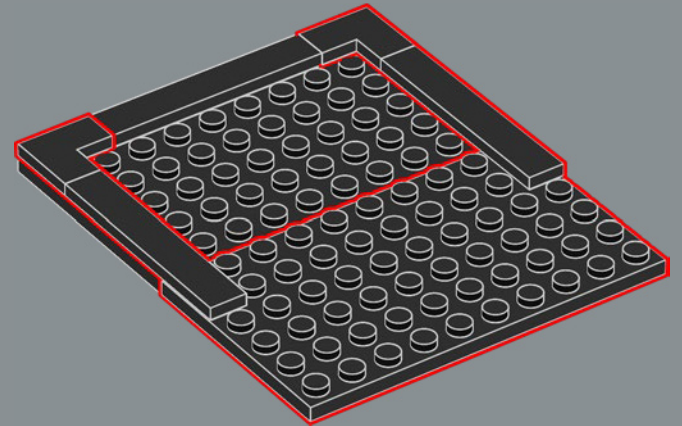

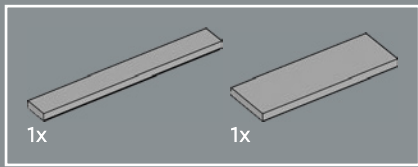

3

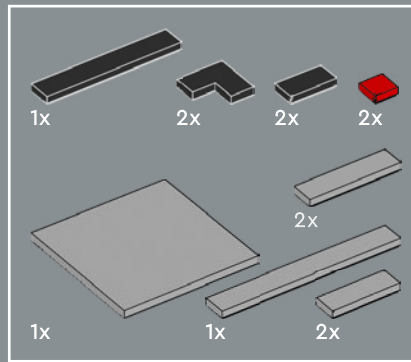
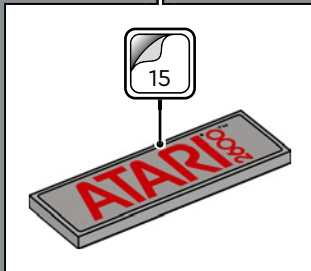
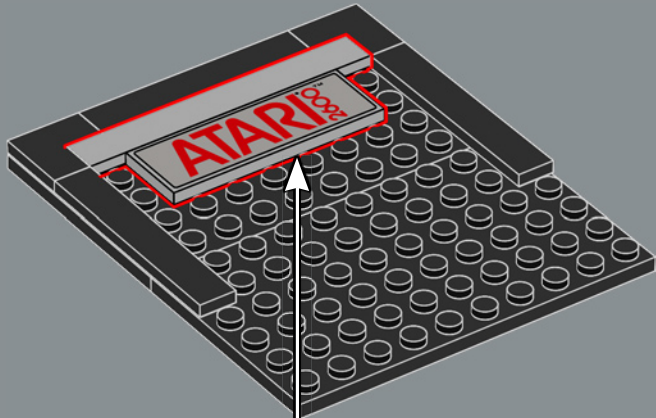

4

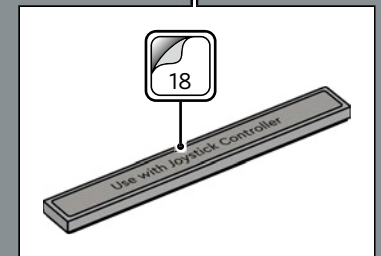
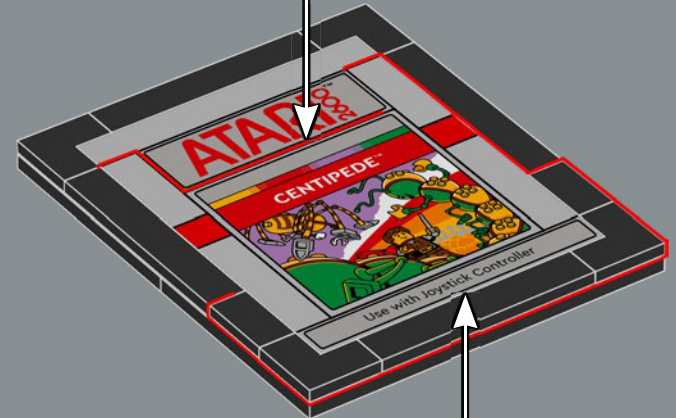

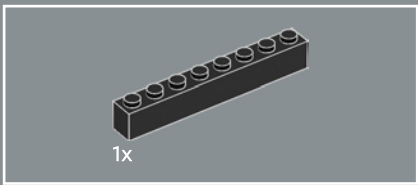

5

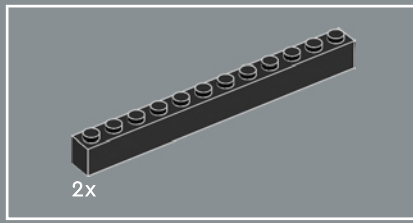
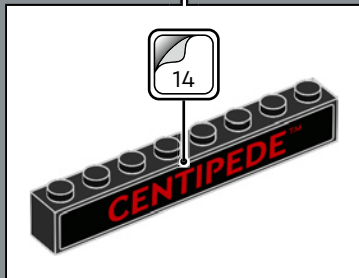

6

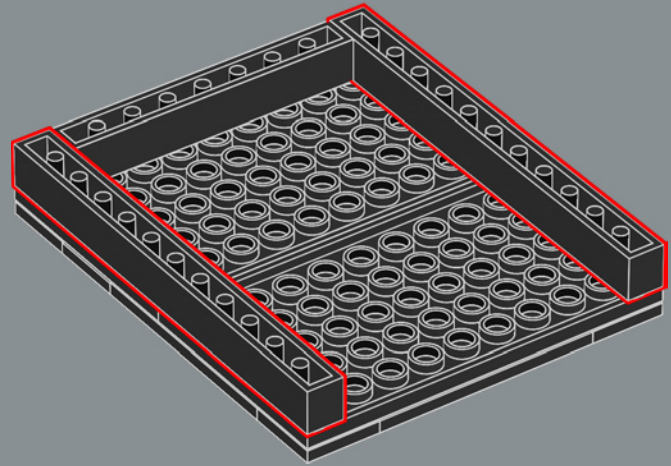

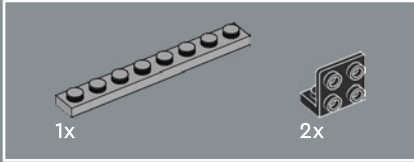
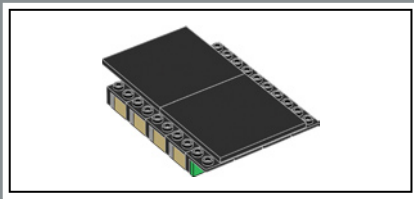

7

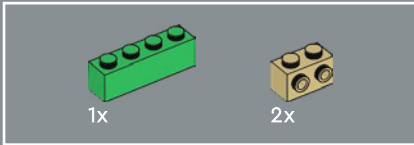
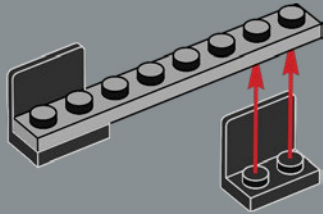

8

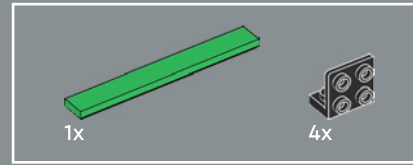
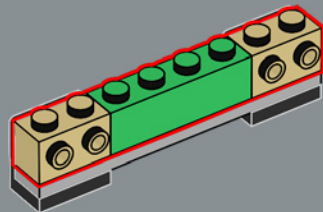

9

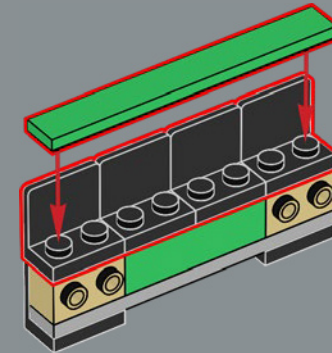

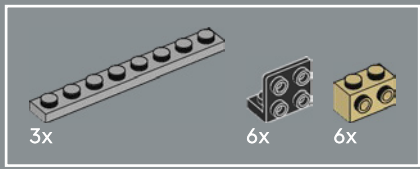

10

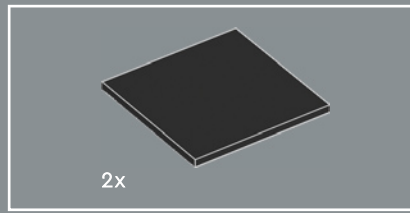
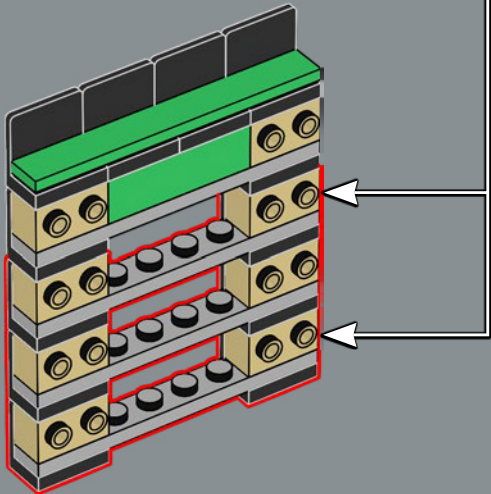
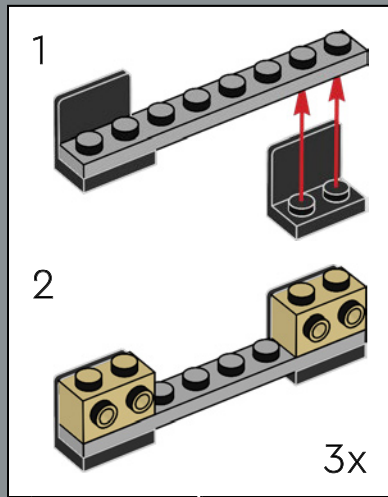

11

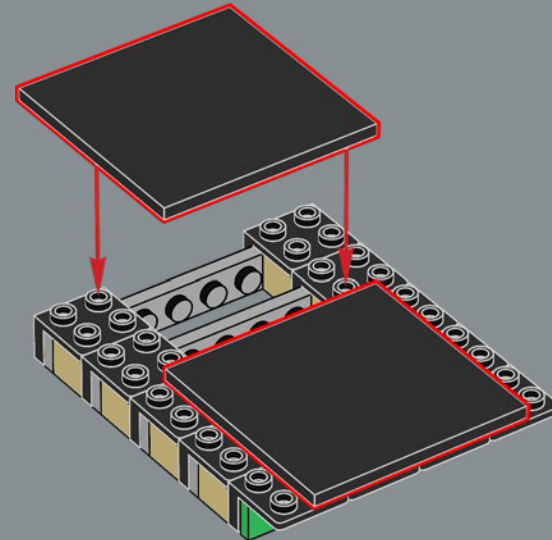

12

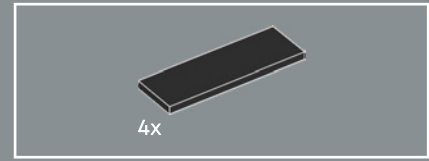
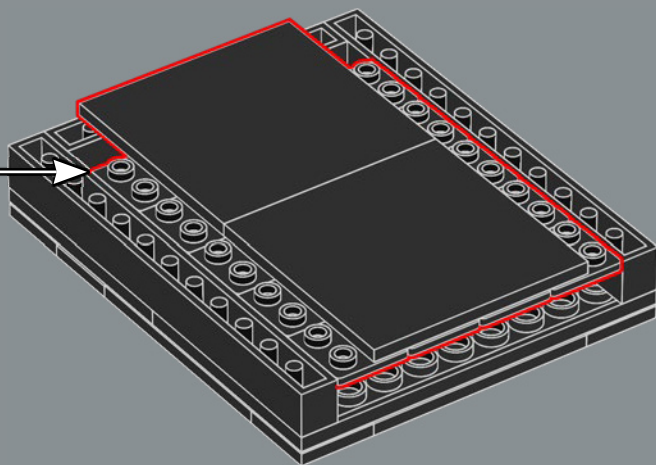

13

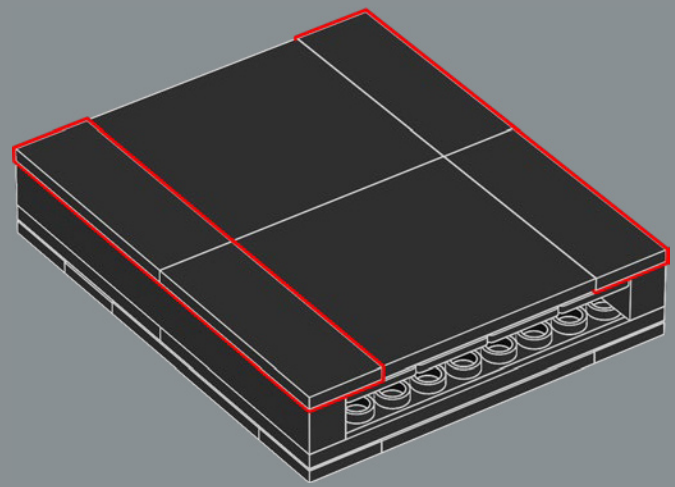

14



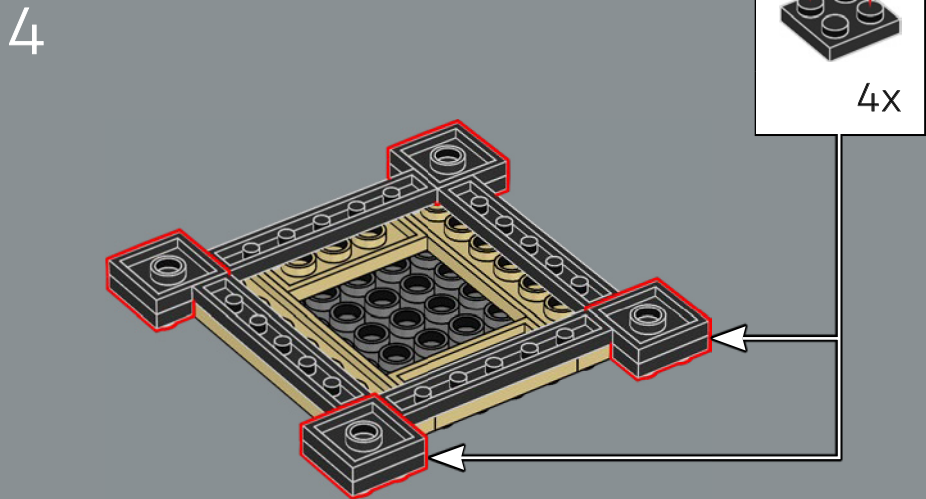
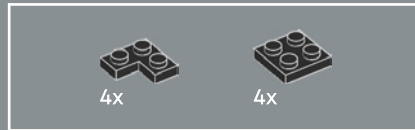
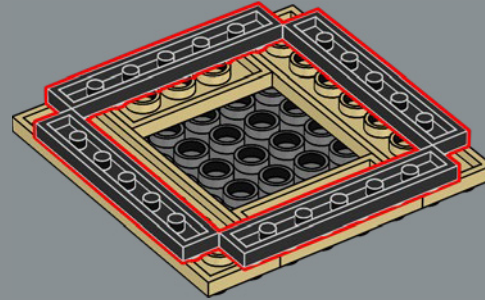
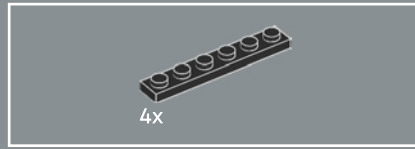
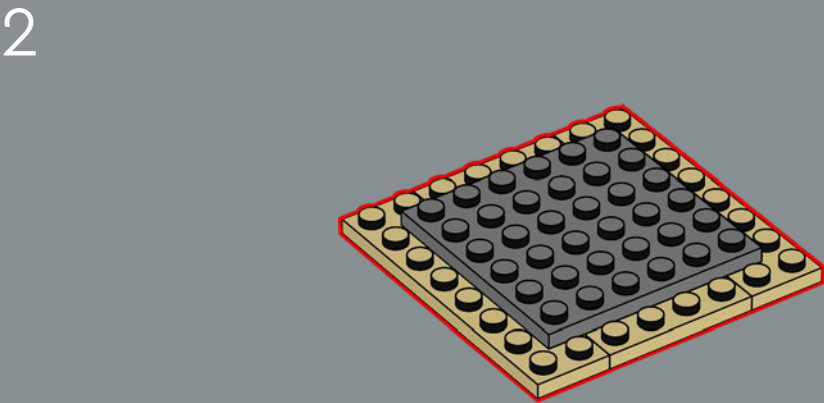
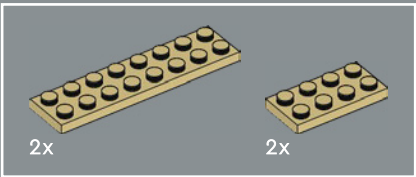
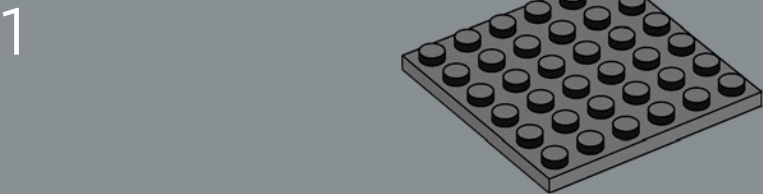
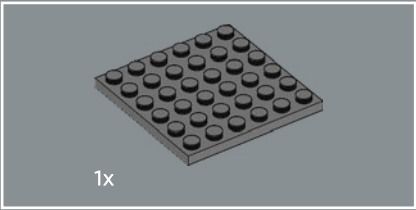
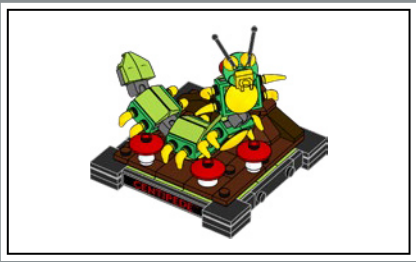



5

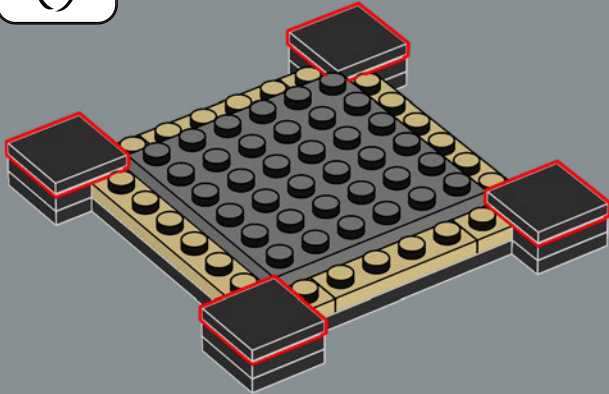

6

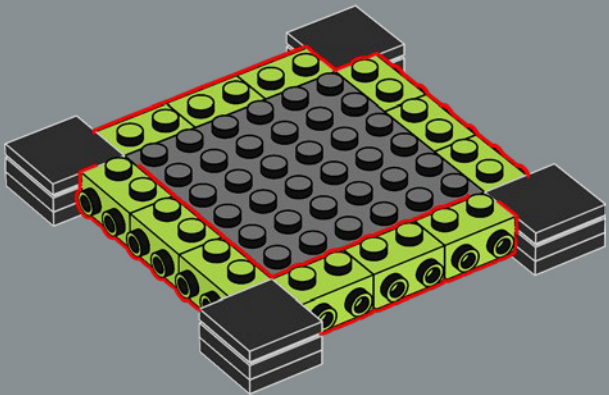

7

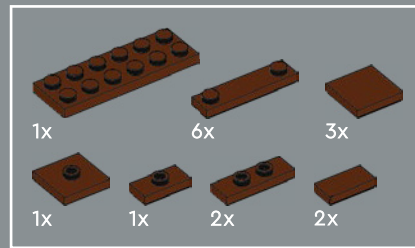
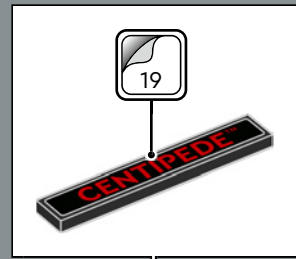
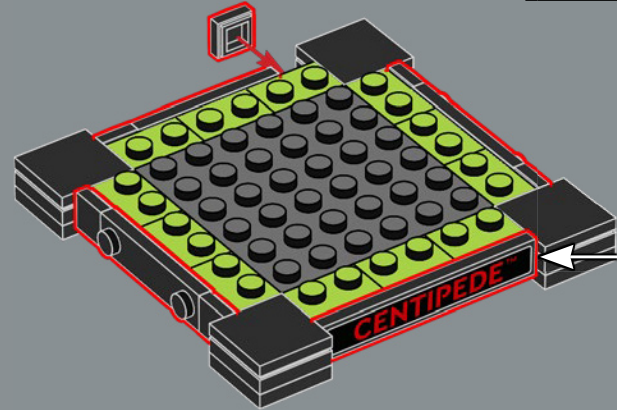

8

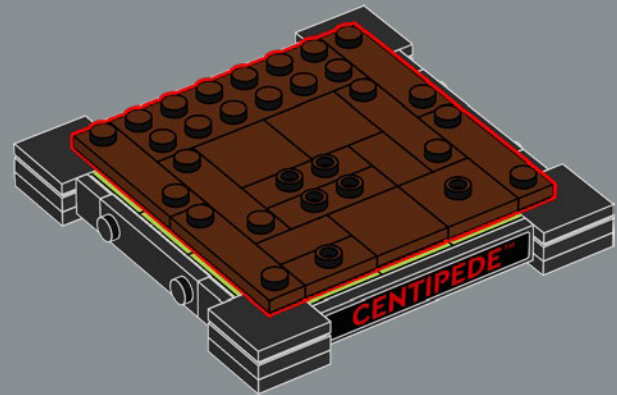

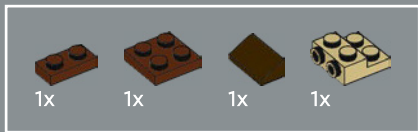

9

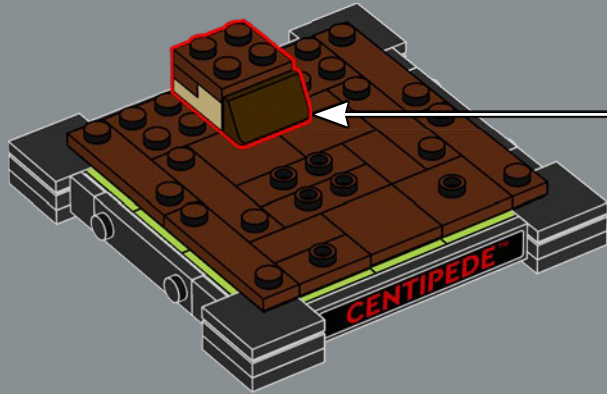
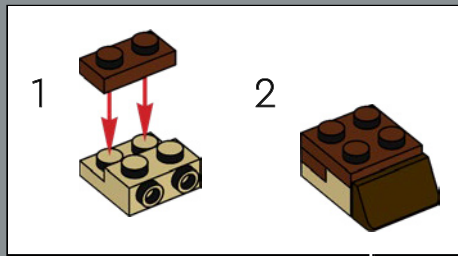

10

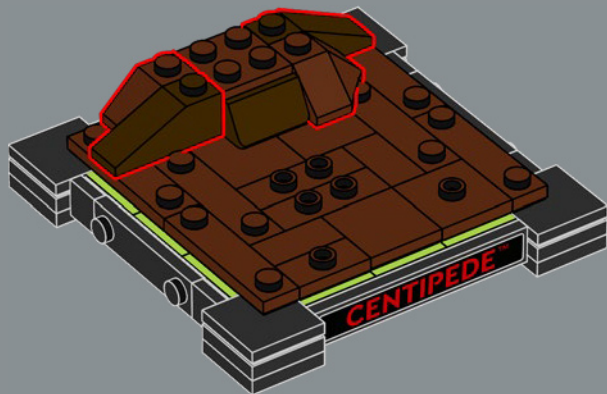

11

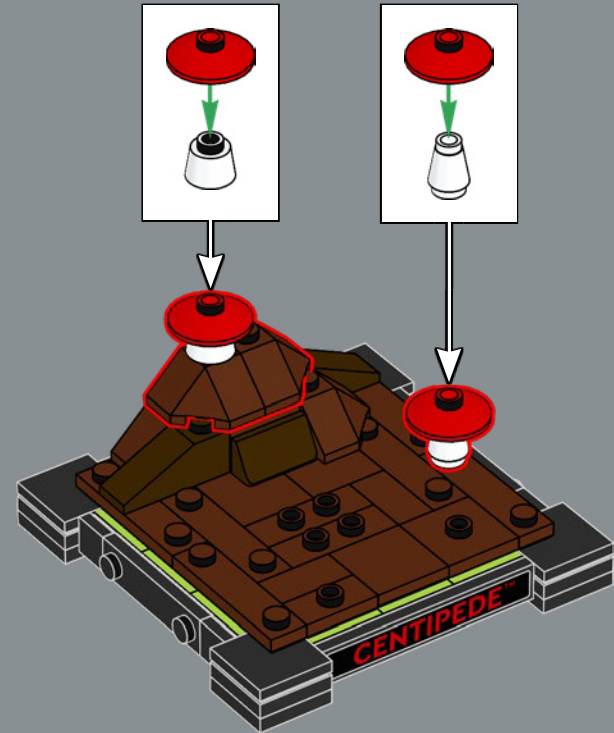

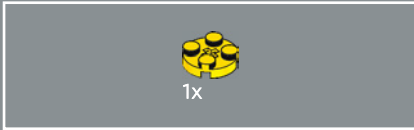
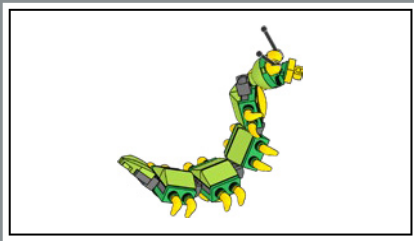

12



13

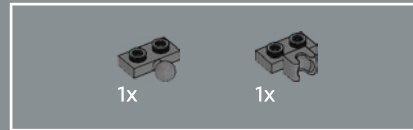

14

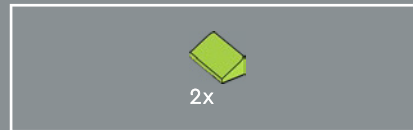
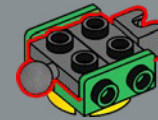

15

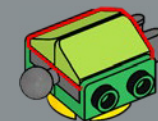



4x

16

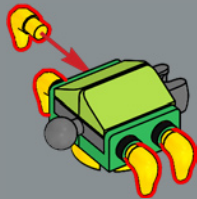

4x



2x



2x



2x



8x



4x

17

1



2

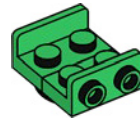

3

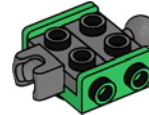

4

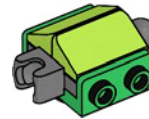

5

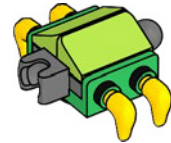

2x

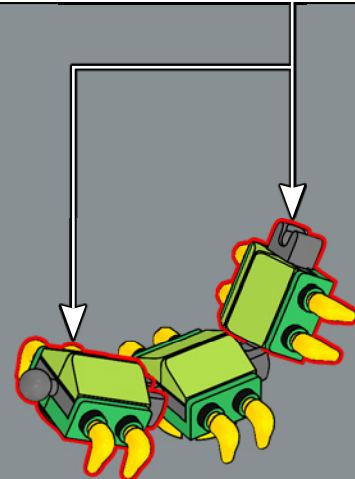

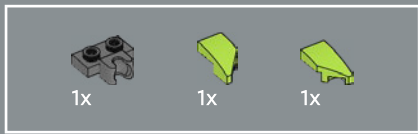

18

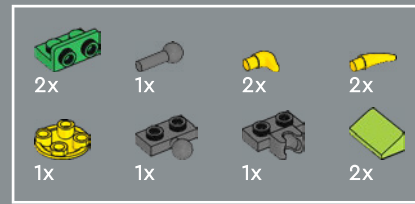
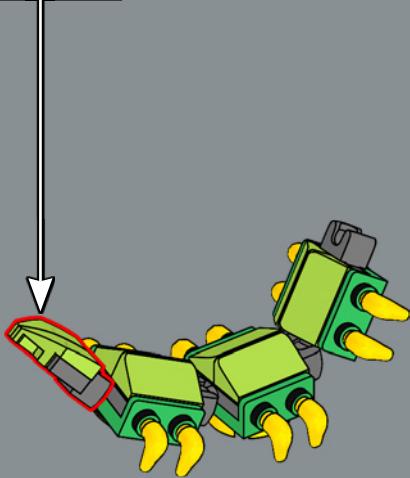
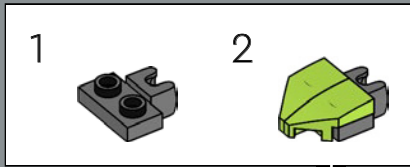

19

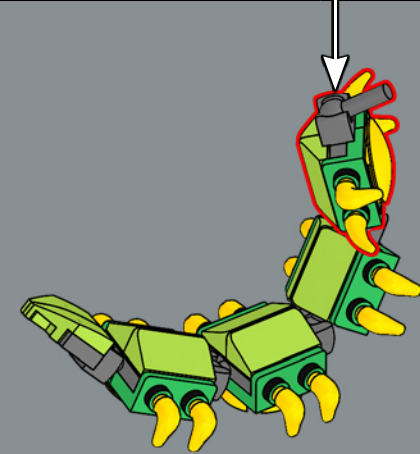
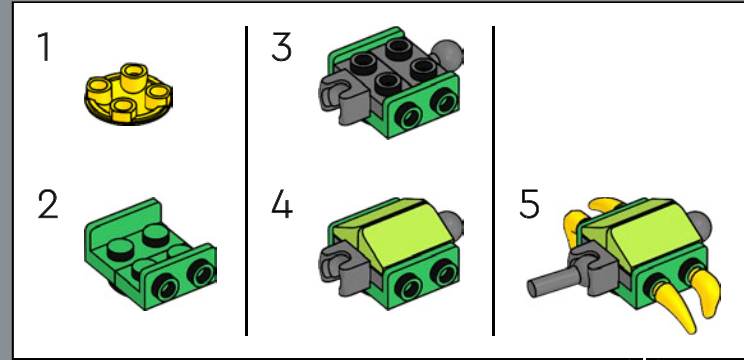

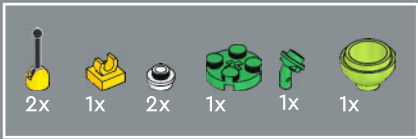

20

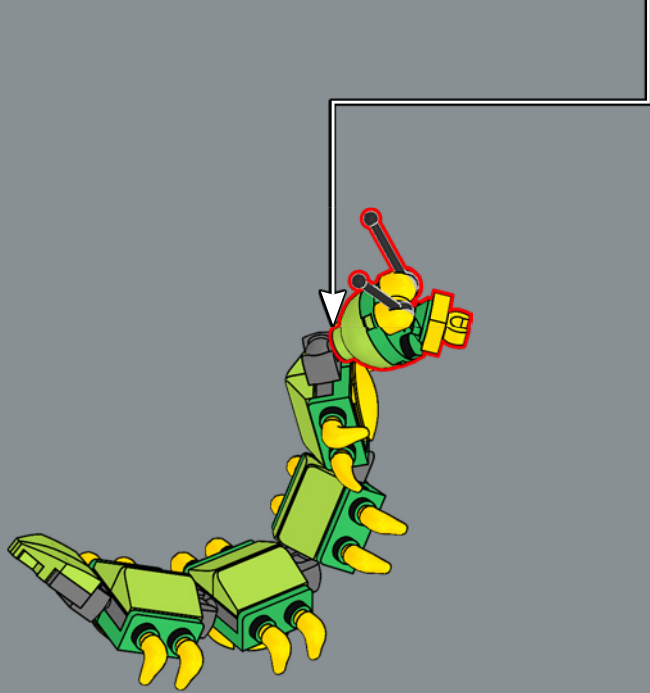
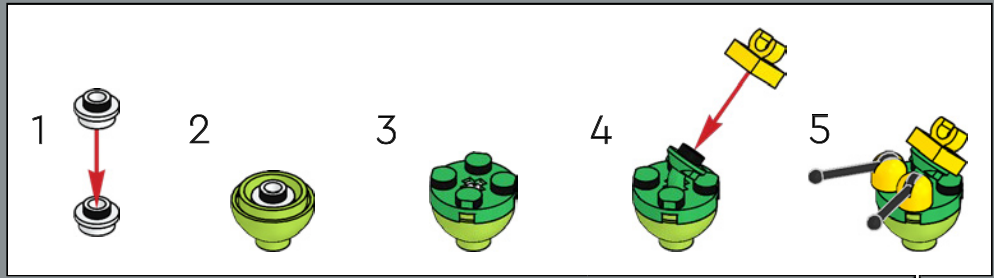

21

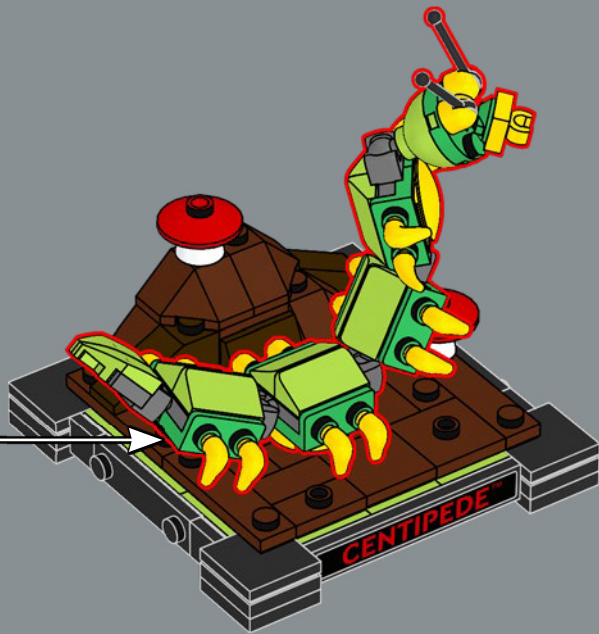

22

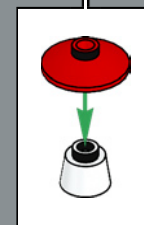
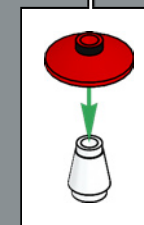
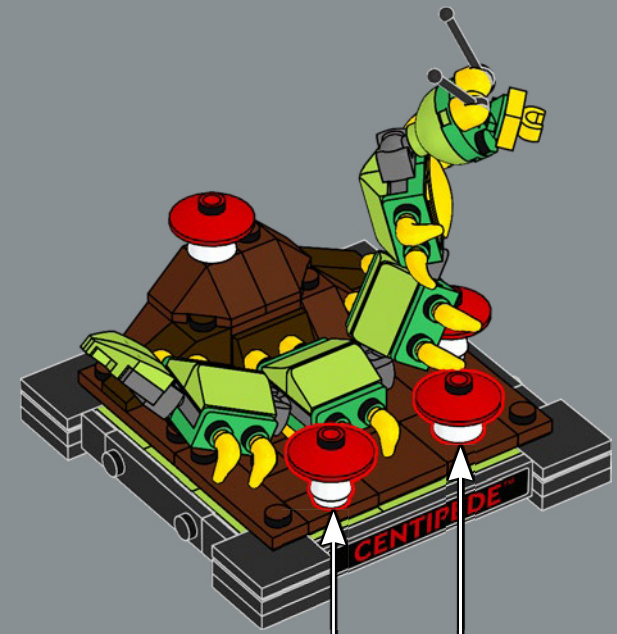
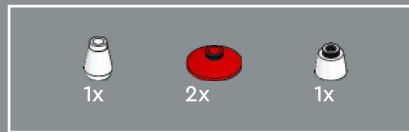



雅达利视频计算机系统于
1977 年 9 月 11 日首次亮相，
售价 189.95 美元 (超过今天的
800 美元!)

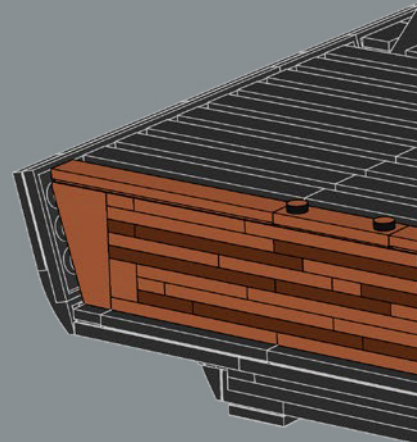
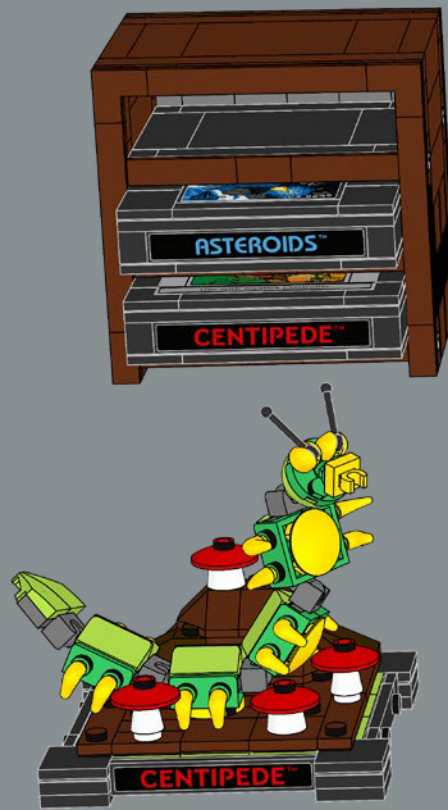
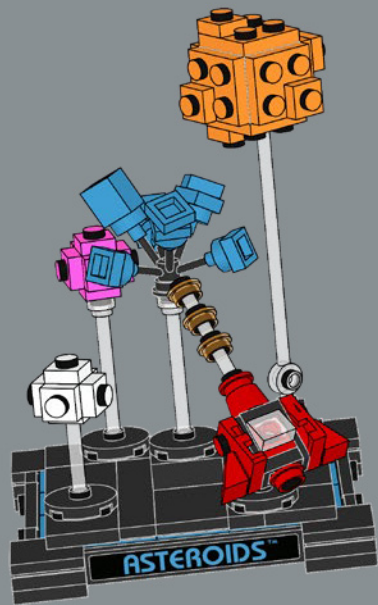
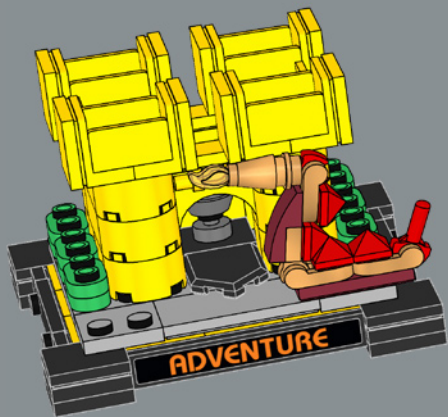



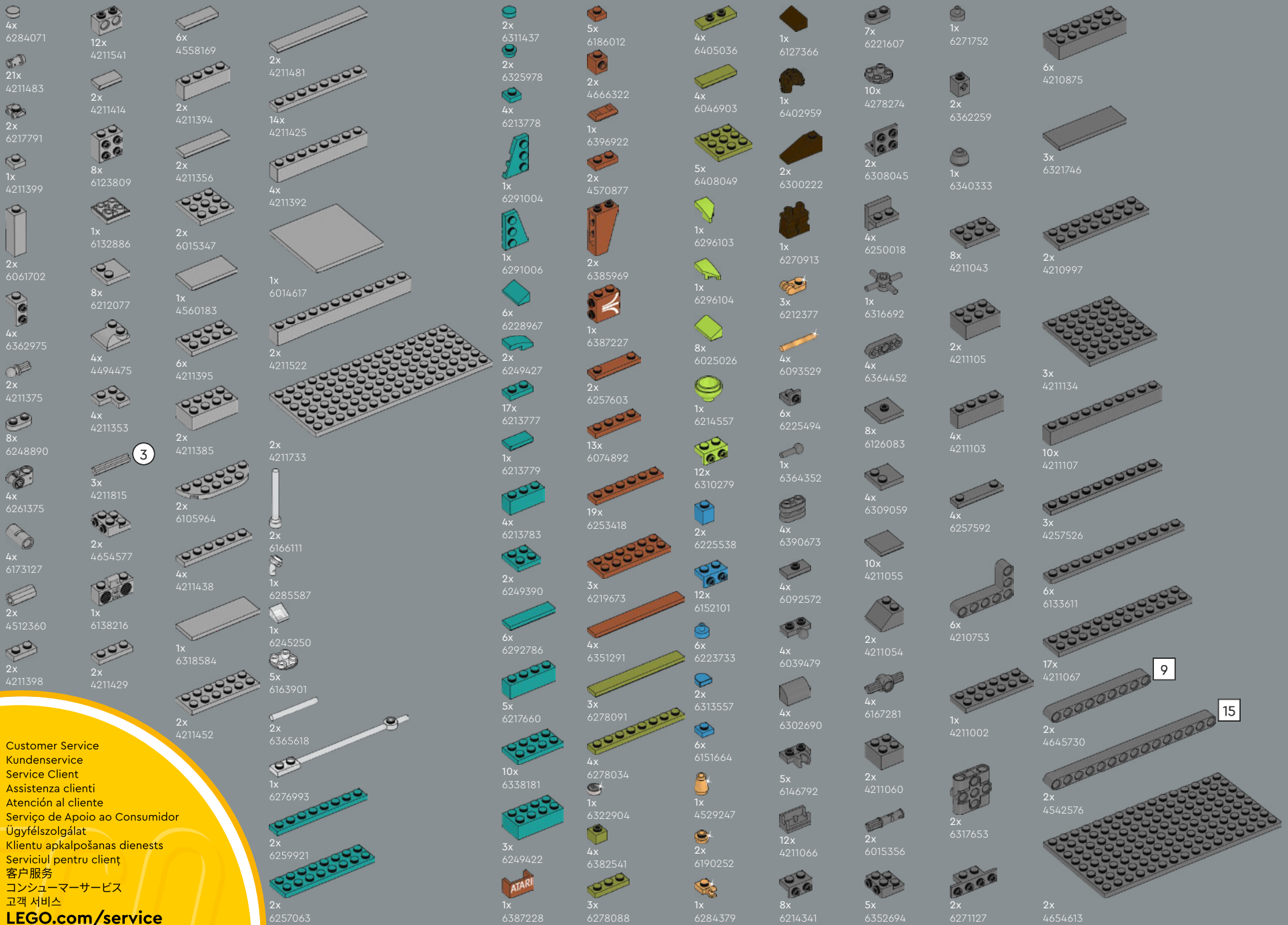

Customer Service
 Kundenservice
 Service Client
 Assistenza clienti
 Atención al cliente
 Serviço de Apoio ao Consumidor
 Ügyfélszolgálat
 Klientu apkalpošanas dienests
 Serviciul pentru client
 客户服务
 コンシューマーサービス
 고객 서비스
LEGO.com/service



FEEDBACK AND WIN



FEEDBACK AND WIN

Your feedback will help shape the future development of this product series.

Please visit:

FEEDBACK UND GEWINNEN

Dein Feedback trägt zur Weiterentwicklung dieser Produktreihe bei.

Geh auf:

COMMENTEZ ET GAGNEZ

Vos commentaires nous aideront à concevoir les futurs produits de cette gamme.

Rendez-vous sur :

COMENTA Y GANA

Tu opinión nos ayudará a dar forma al desarrollo de esta serie de productos en el futuro.

Visita:

反馈有奖

您的反馈将有助于我们在今后改进本系列产品。

请访问：

[LEGO.com/productfeedback](https://www.lego.com/productfeedback)

By completing, you will automatically enter a drawing to win a LEGO® set.

Terms & Conditions apply.

Durch Ausfüllen nimmst du automatisch an der Verlosung eines LEGO® Preises teil.

Es gelten die Teilnahmebedingungen.

En envoyant vos commentaires, vous serez automatiquement inscrit(e) à un tirage au sort qui vous permettra de remporter un prix LEGO®.

Offre soumise à conditions.

Al contestar, participarás automáticamente en el sorteo y podrás ganar un set LEGO®.

Sujeto a Términos y Condiciones.

完成我们的反馈调查,即可自动进入抽奖环节,赢取乐高®套装。

适用《条款和条件》。

LEGO and the LEGO logo are trademarks of the LEGO Group. ©2022 The LEGO Group.

©2022 Atari Interactive, Inc. Atari and the Atari logo are registered trademarks owned by Atari Interactive, Inc. Used under license.