

ENLIGHTEN  
啓蒙

Brick<sup>TM</sup>



Corsair Series:  
ROYAL WARSHIP

305  
AGES 9+

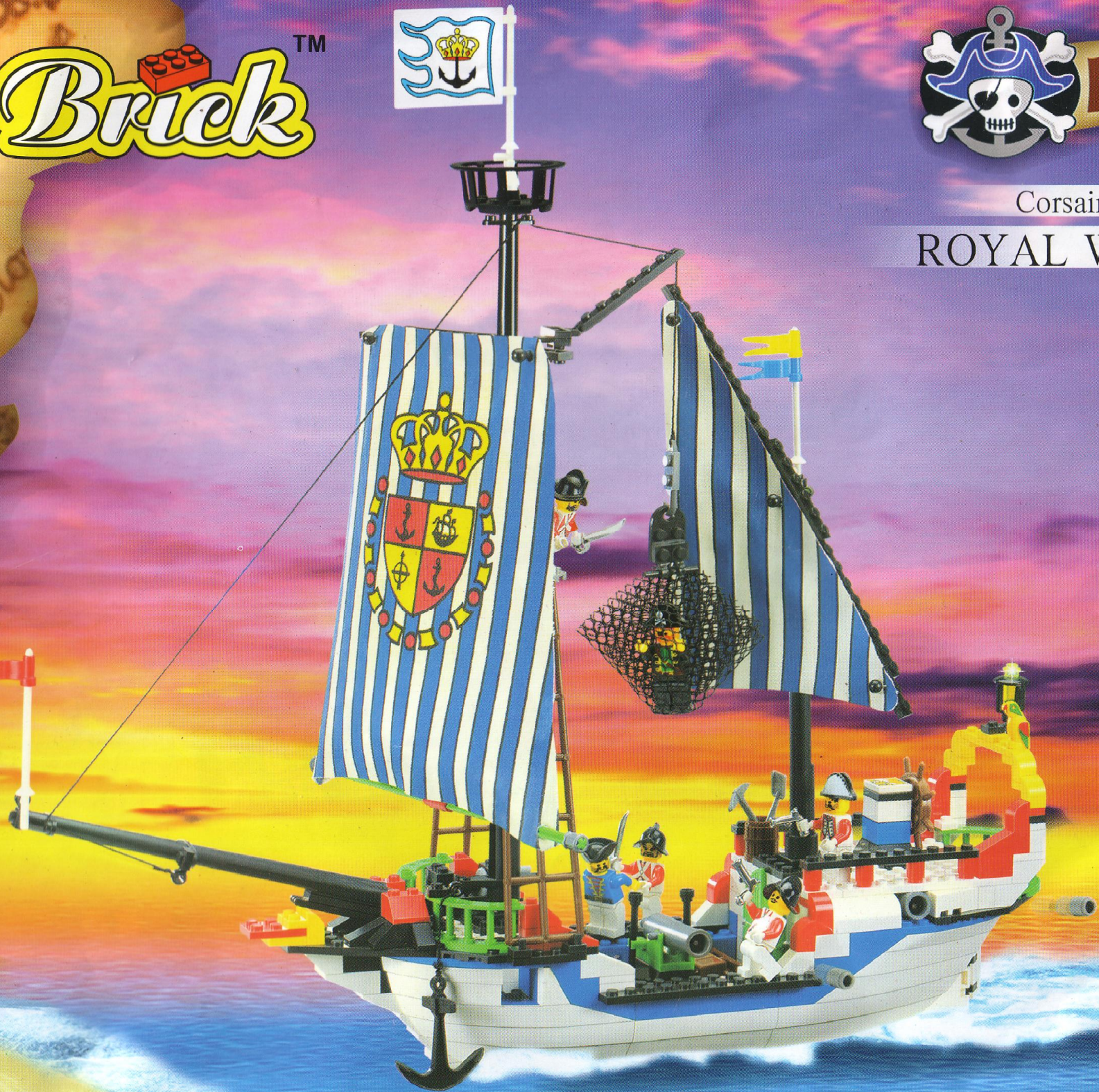

皇家战船



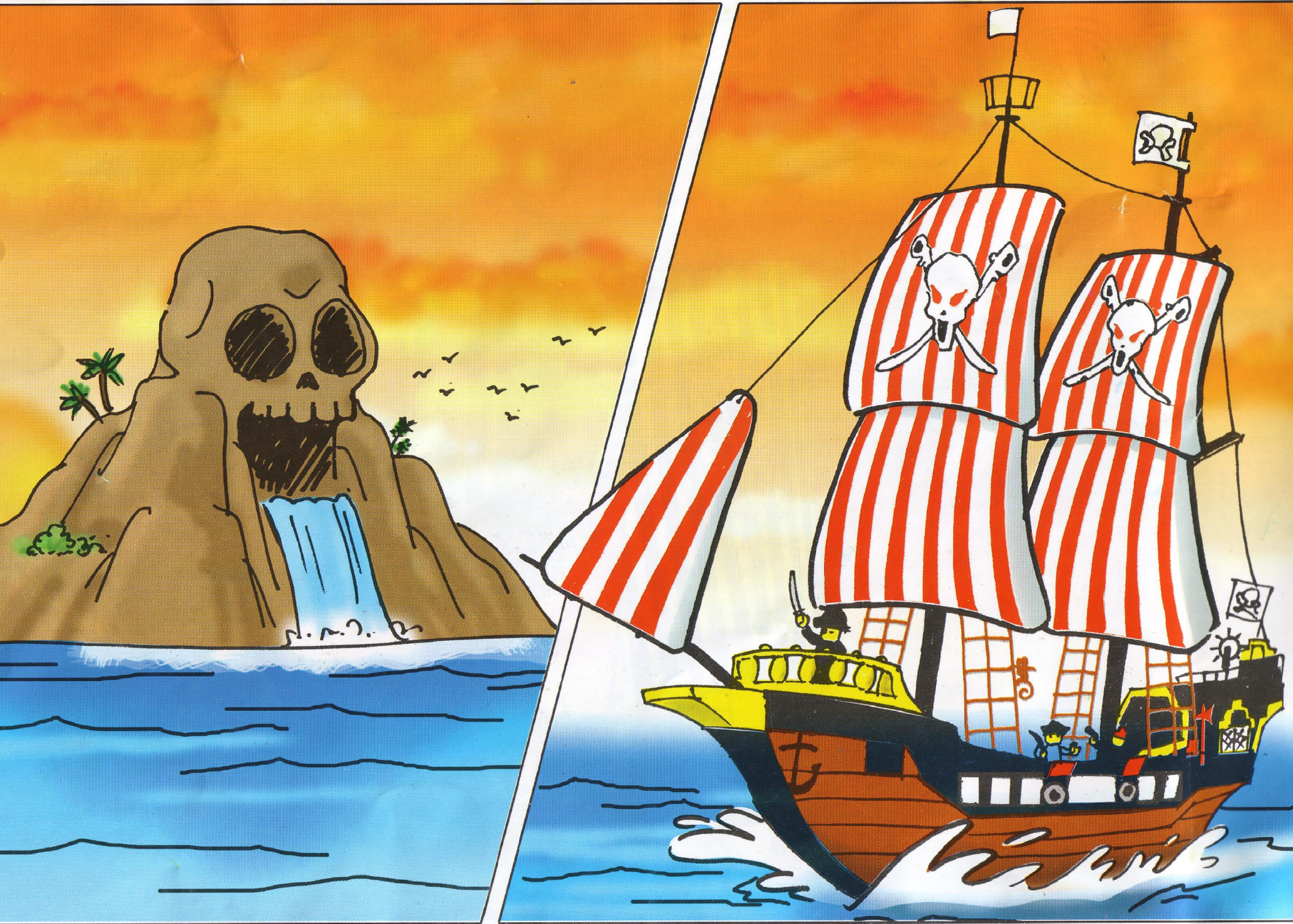







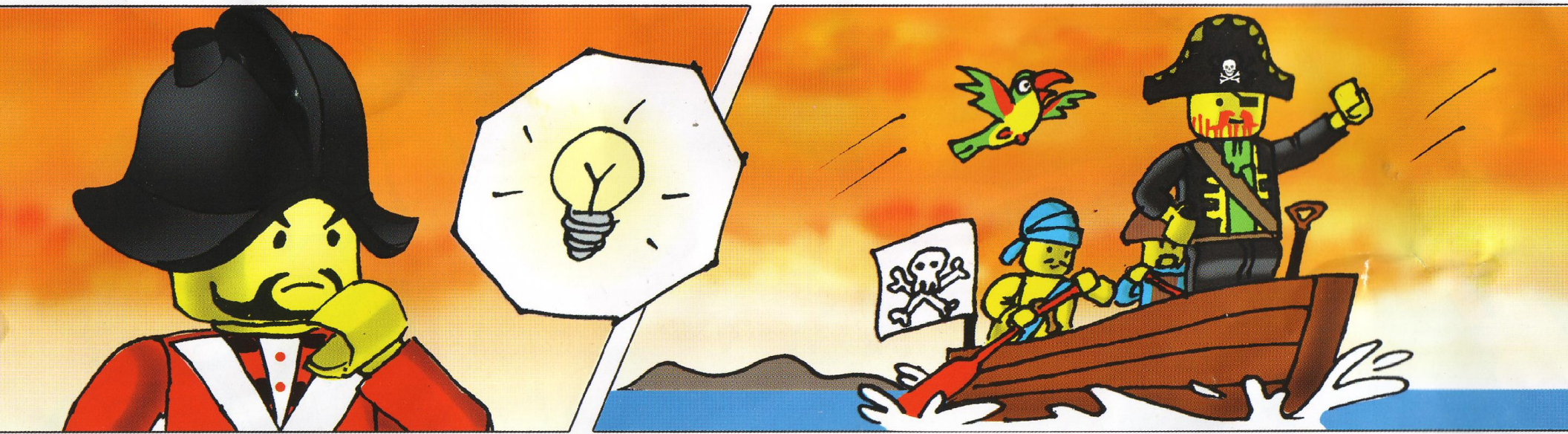







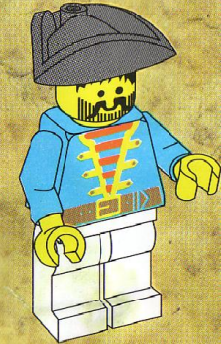
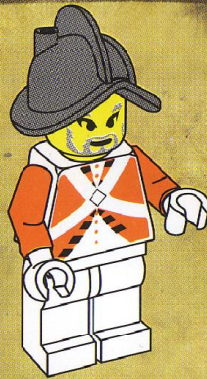
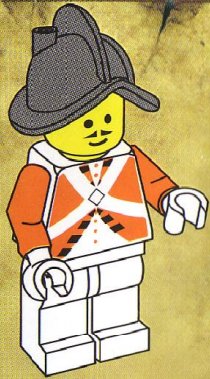
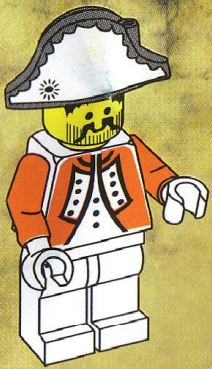
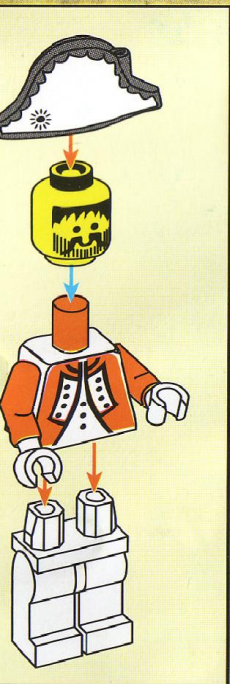

1

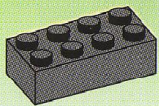

4X

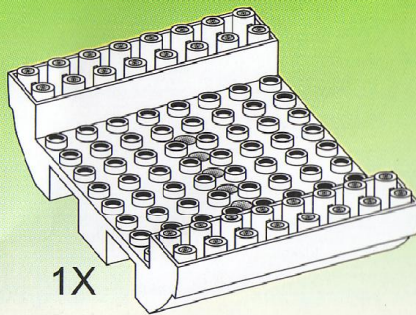

1X

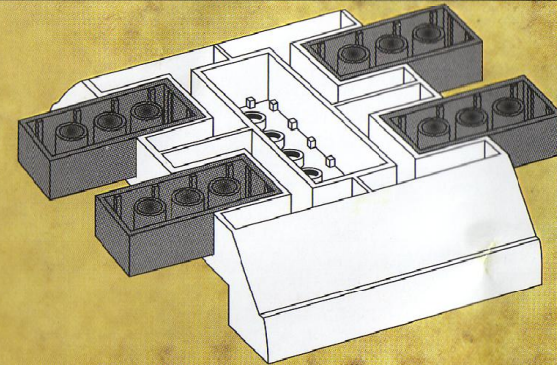

2

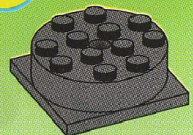

1X

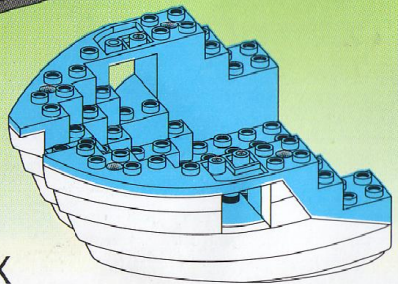

1X

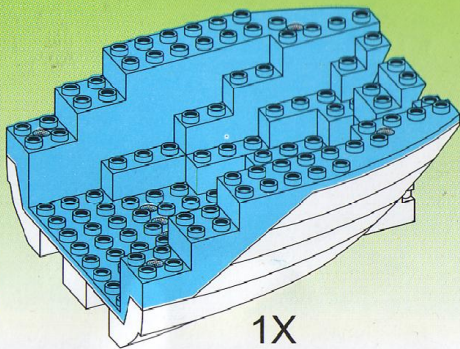

1X

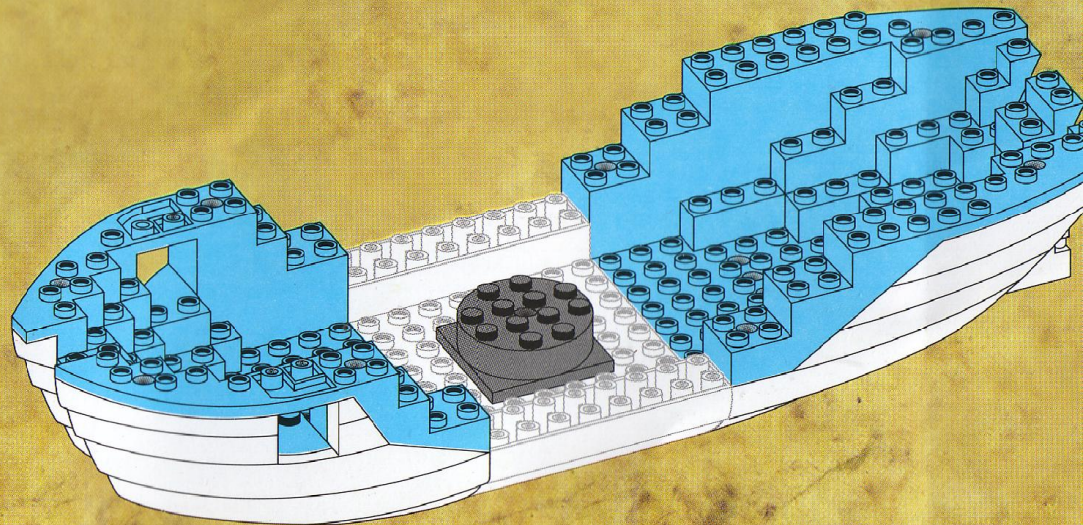



3

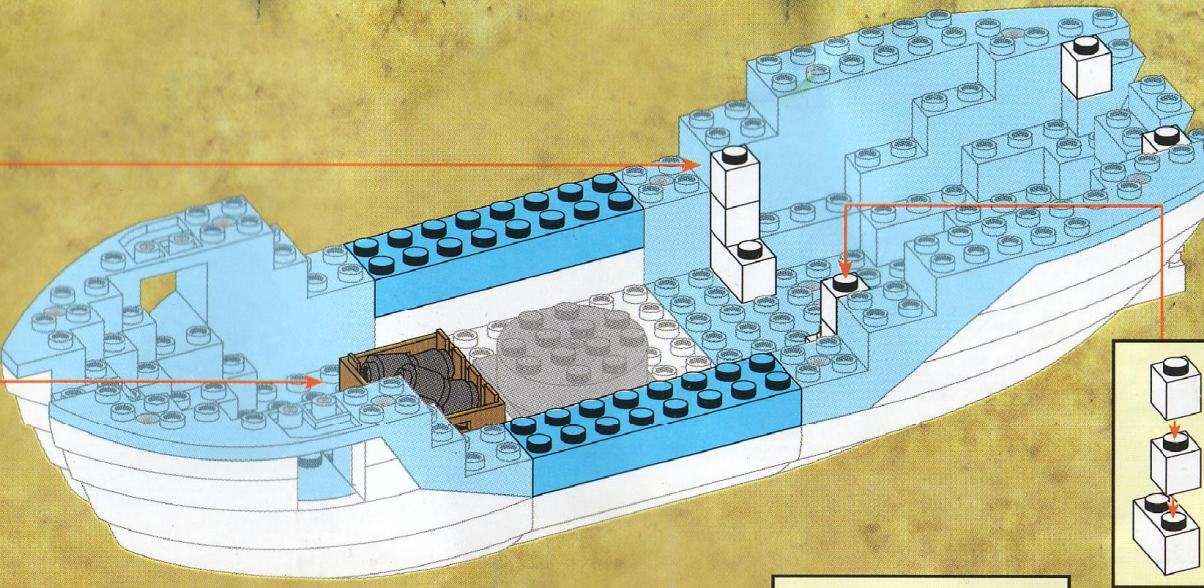
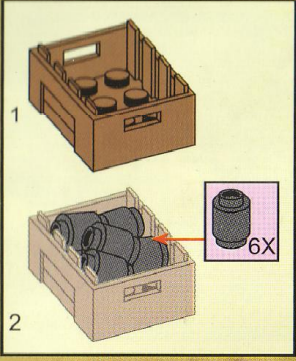
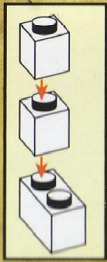
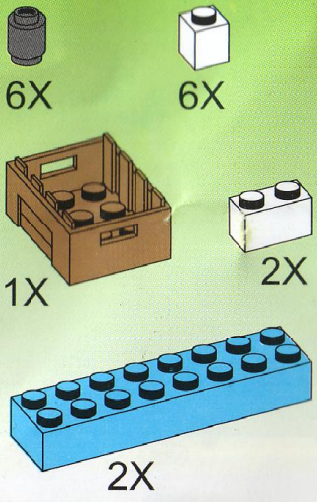

4

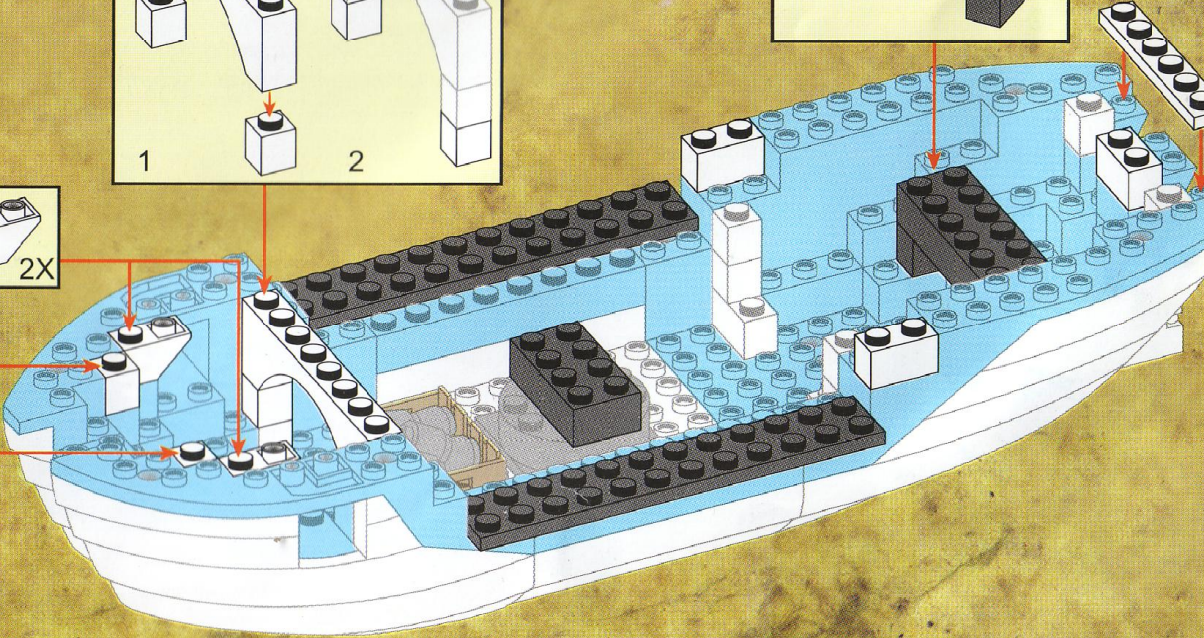
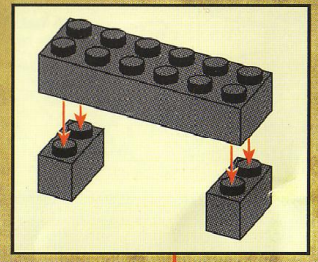
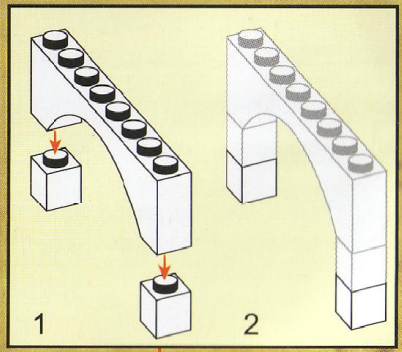
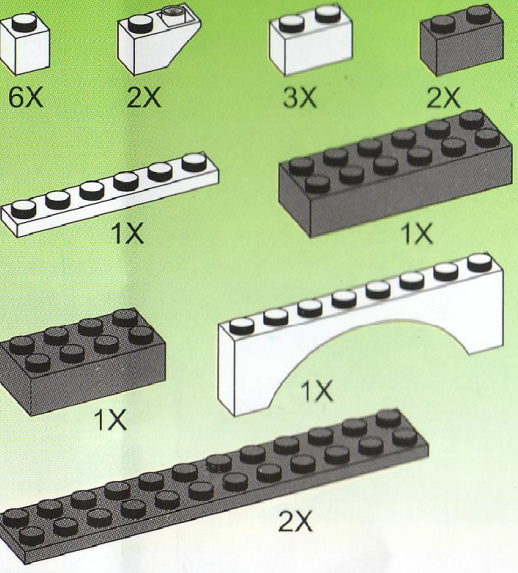



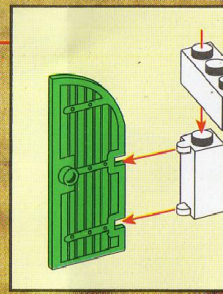
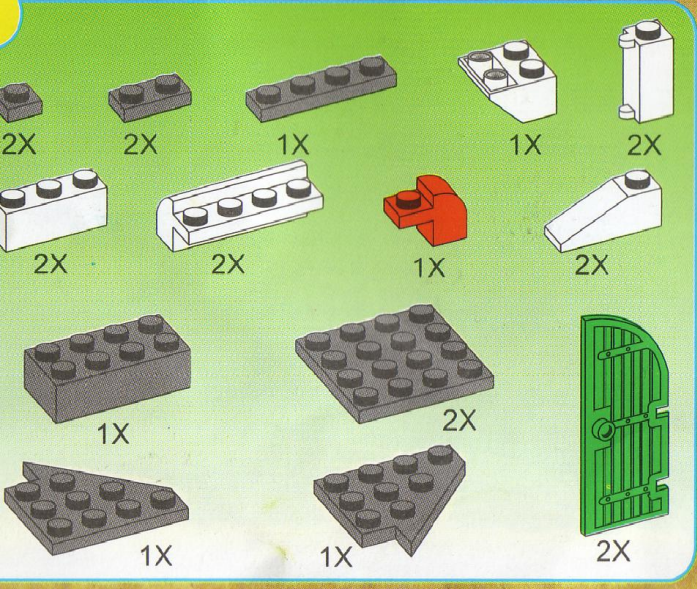
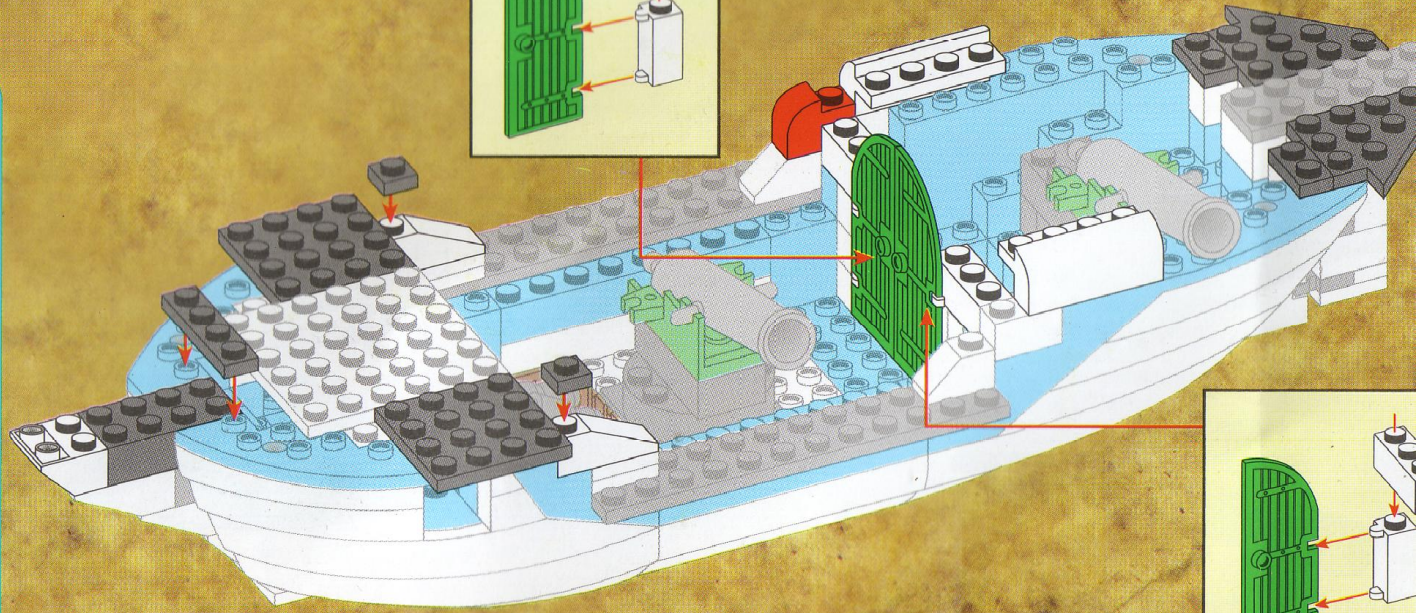
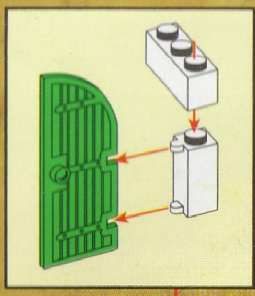
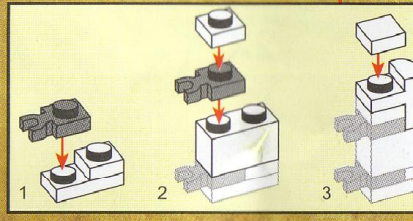
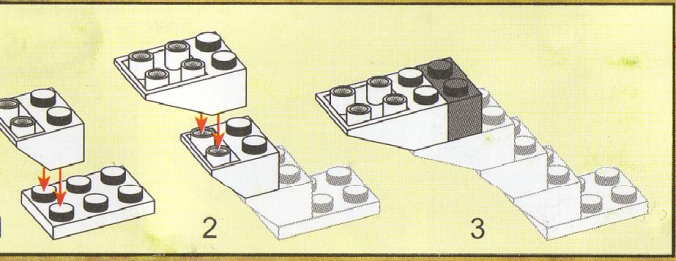
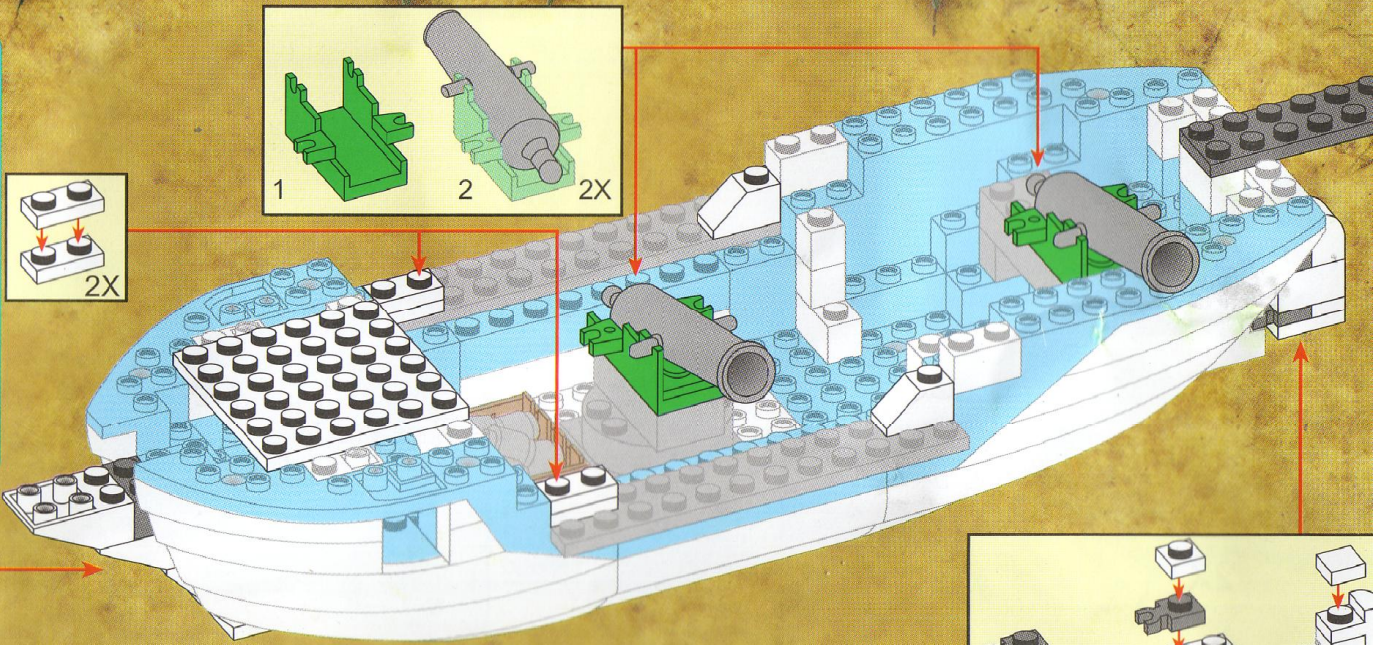
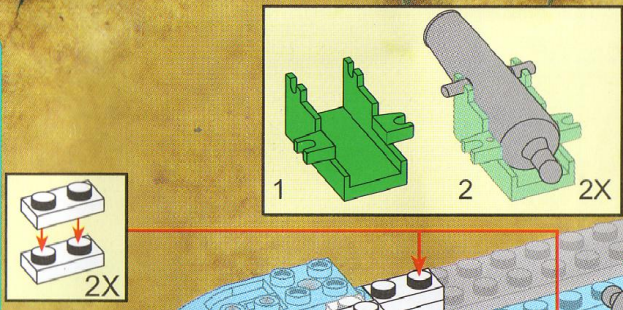
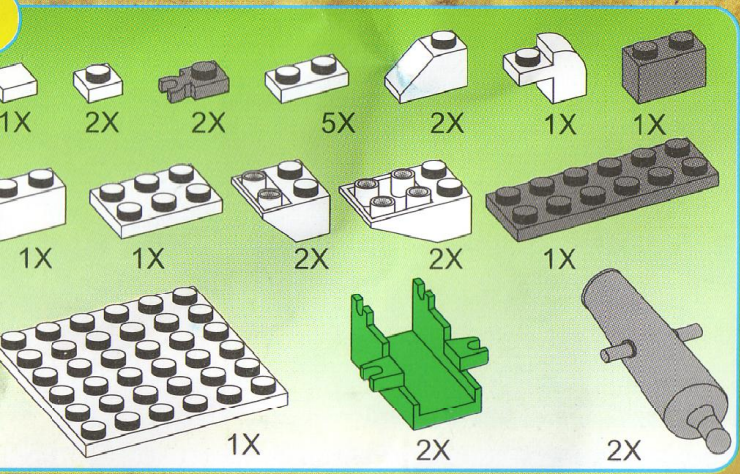



7

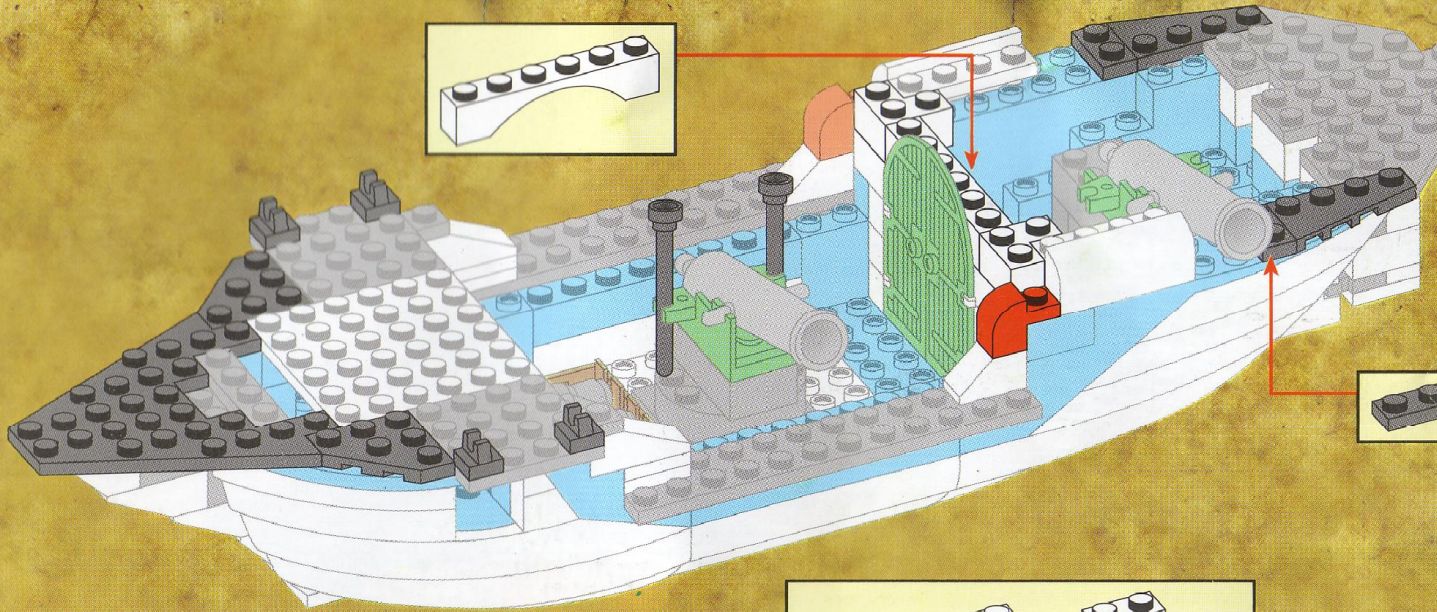
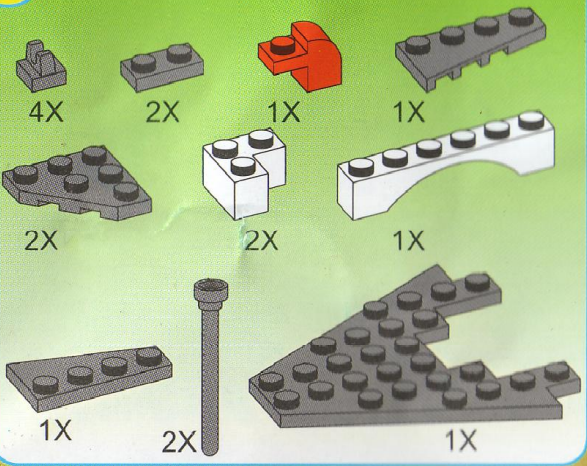

8

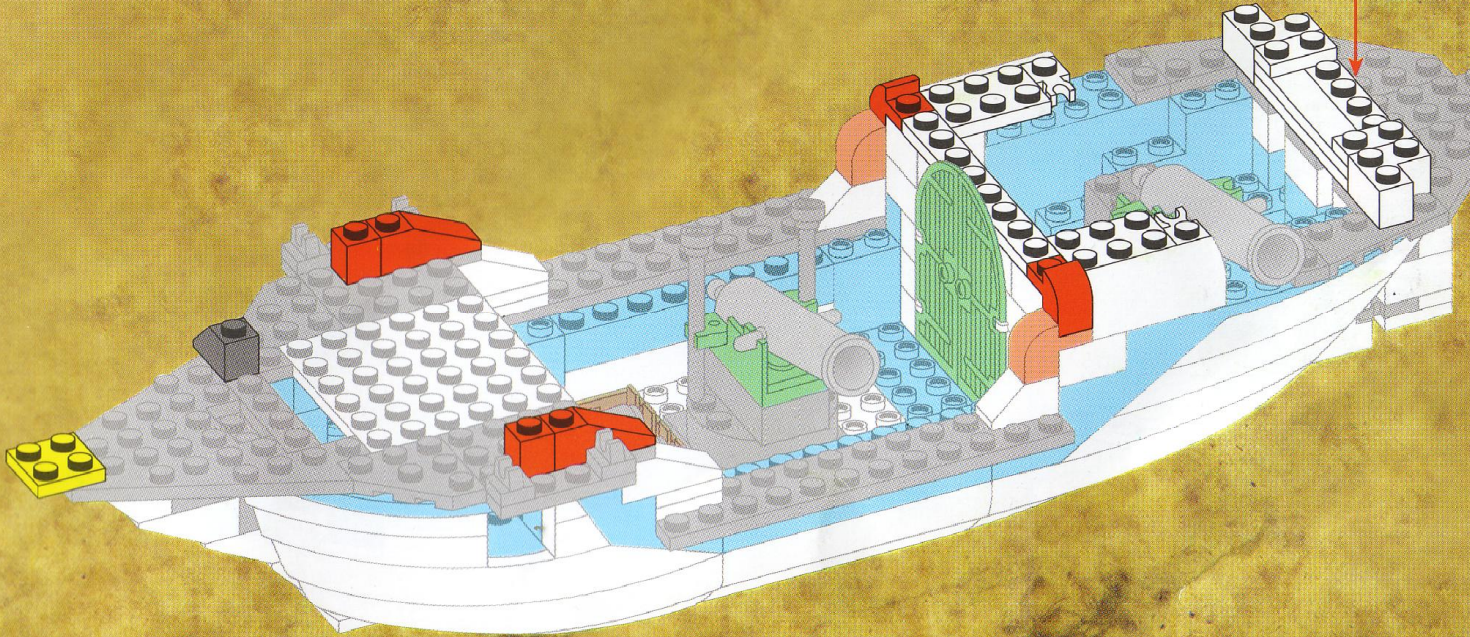
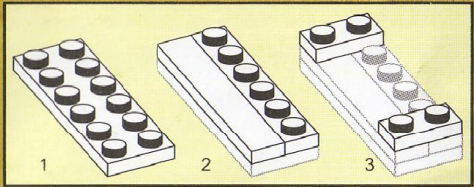
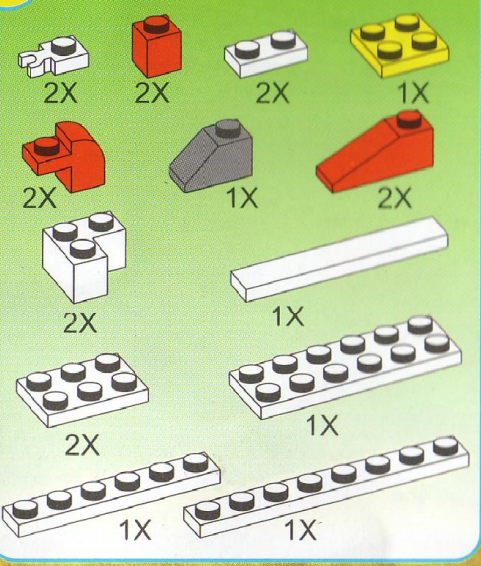



9



2X



2X



2X



1X



2X

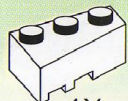

1X

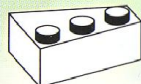

1X

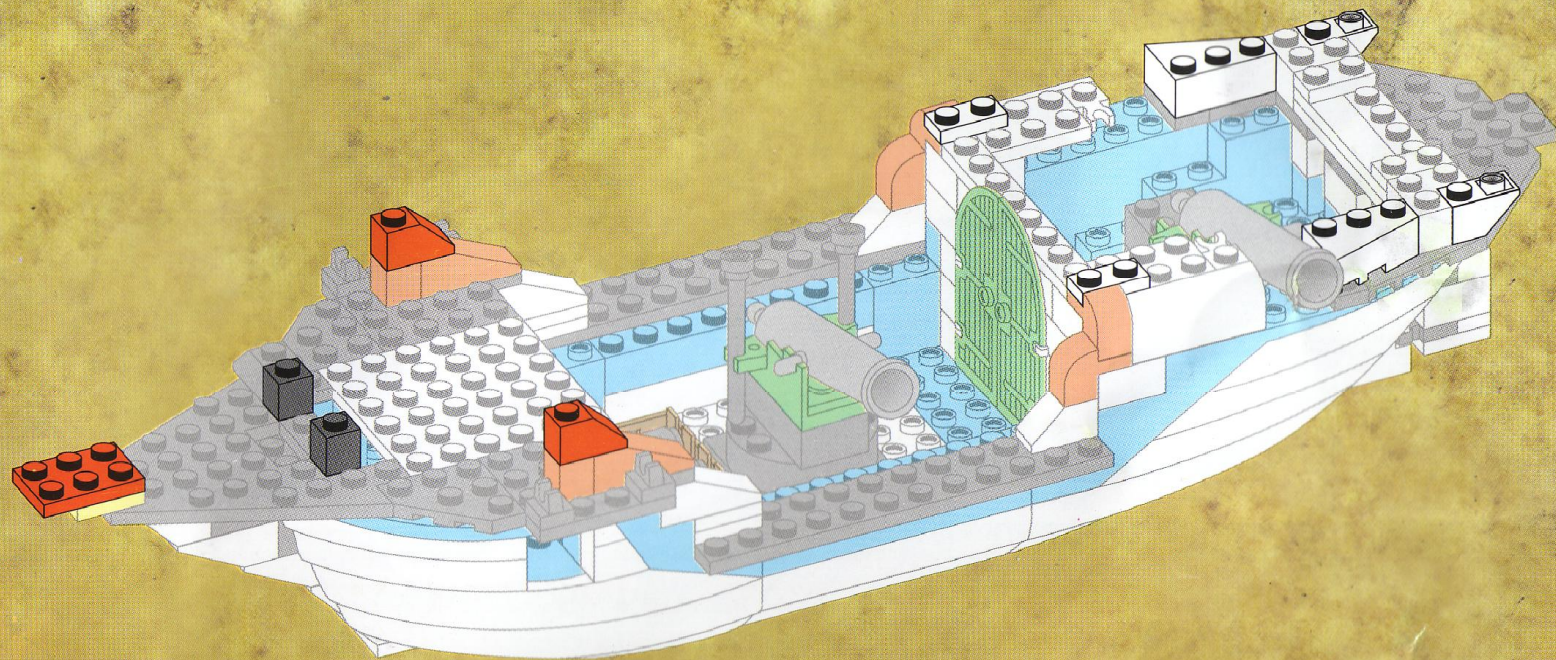

10



2X



3X



2X

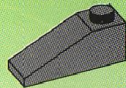

2X

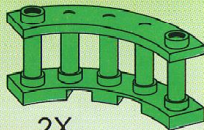

2X

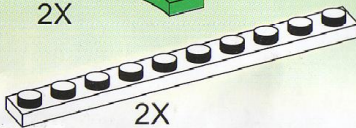

2X

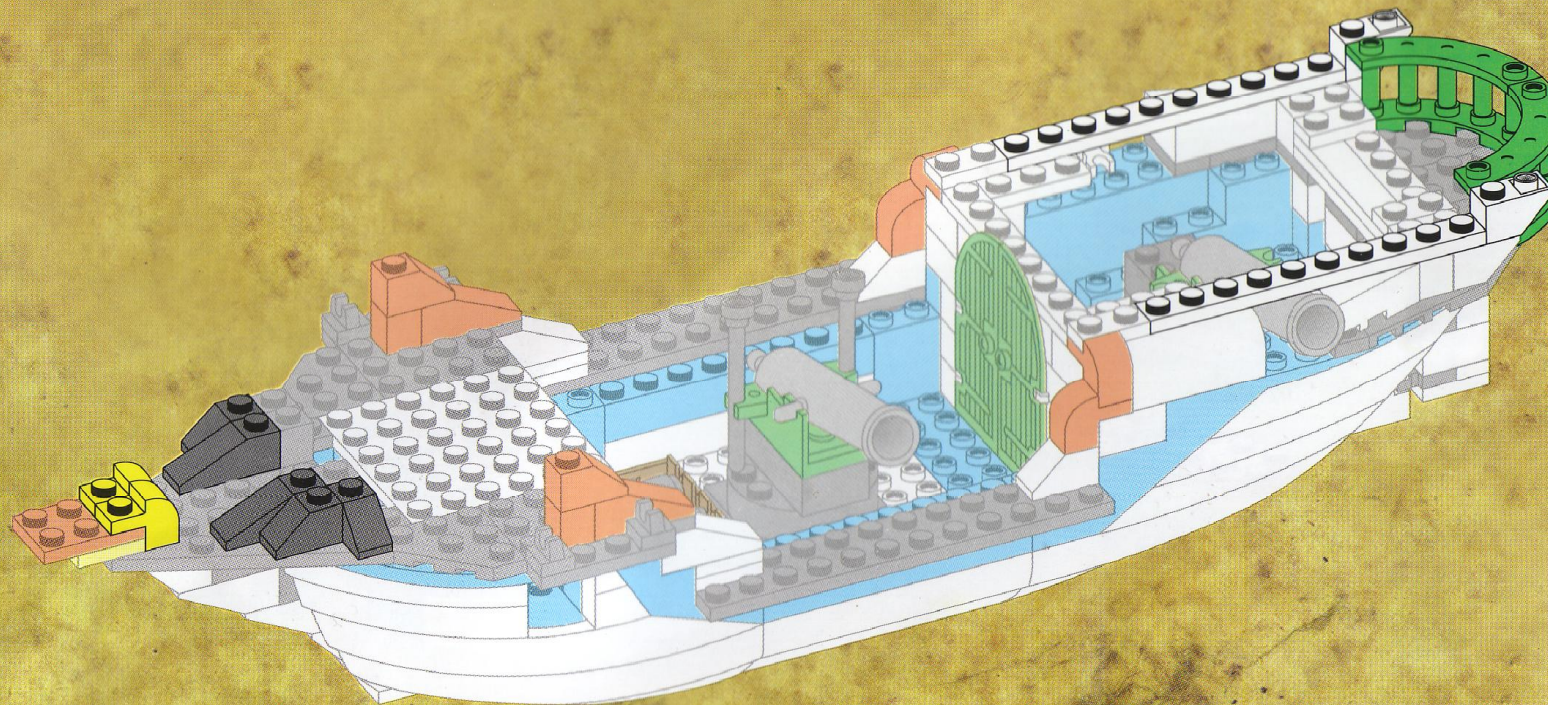







3

- 2X [Grey 1x2 Technic Brick]
- 2X [White 1x2 Technic Brick]
- 2X [White 1x2 Technic Brick]
- 2X [Red 1x2 Technic Brick]
- 2X [Grey 1x10 Technic Beam]
- 1X [Wooden Barrel]
- 2X [Red 1x2 Technic Brick]
- 1X [Red 1x2 Technic Brick]
- 1X [Grey 1x4 Technic Plate with Hole]
- 1X [Grey 1x4 Technic Plate with Hole]
- 1X [Grey 1x4 Technic Plate with Hole]
- 2X [Grey 1x4 Technic Plate with Hole]
- 2X [Yellow 1x2 Technic Coin]
- 1X [Brown 1x4 Technic Chest]
- 1X [Brown 1x4 Technic Chest]

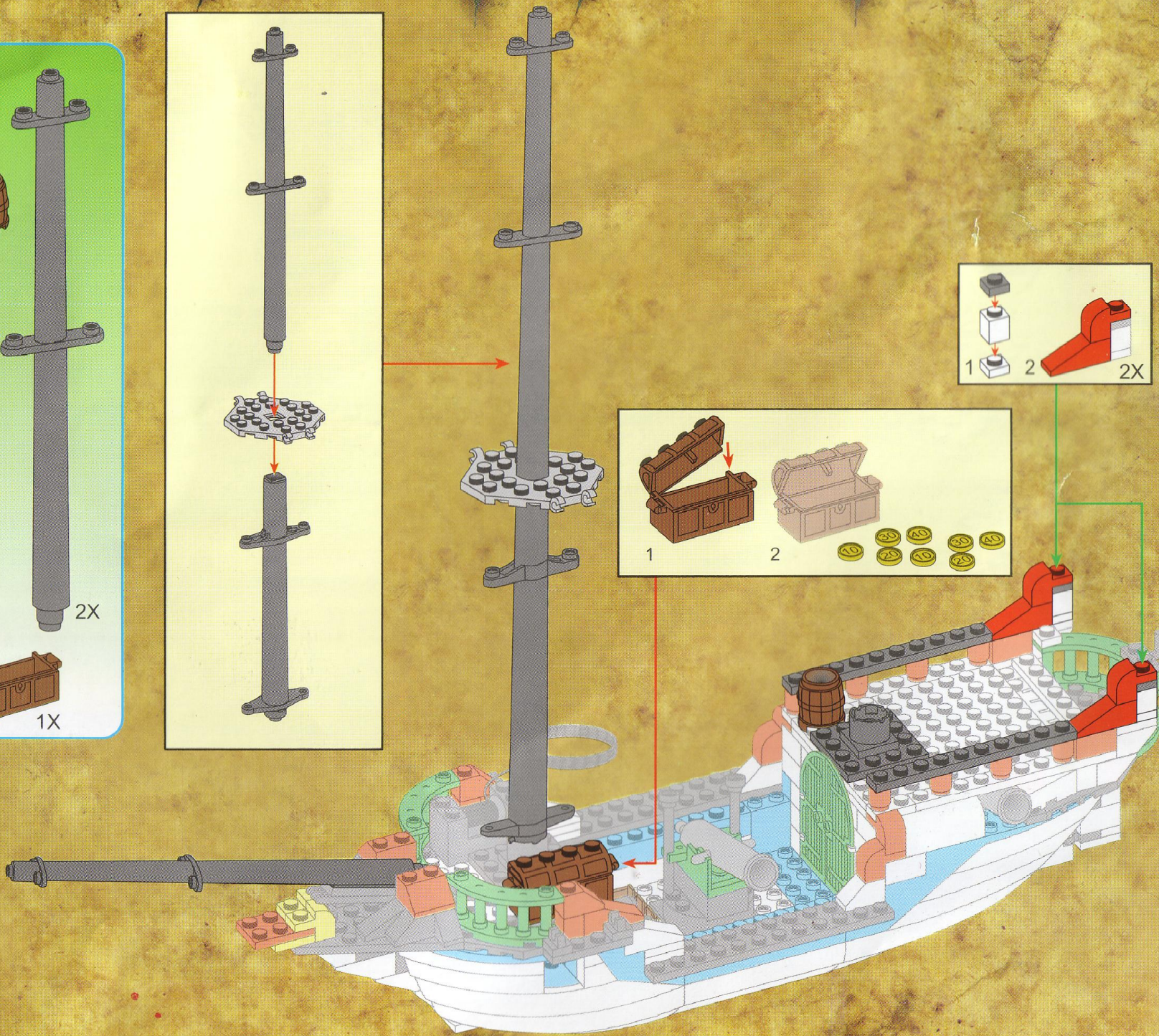
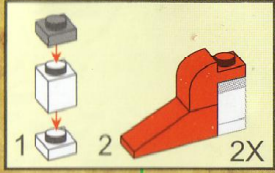
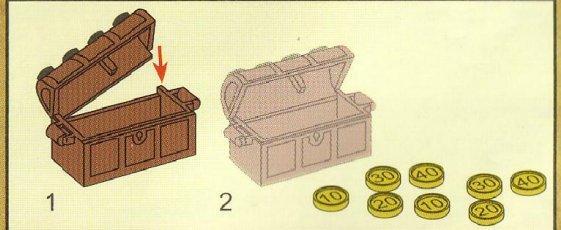
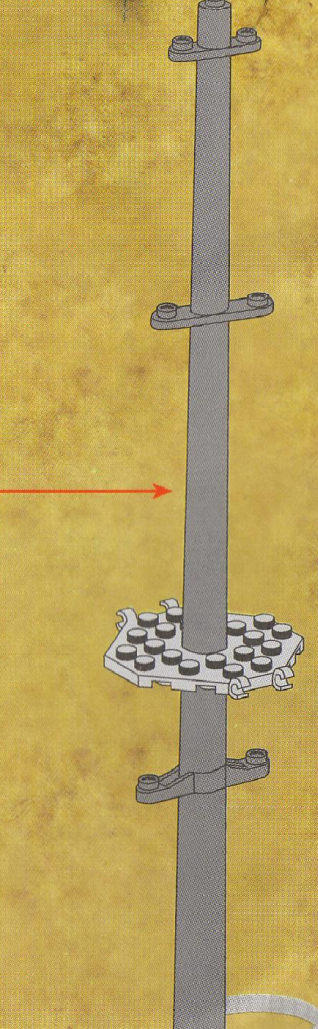
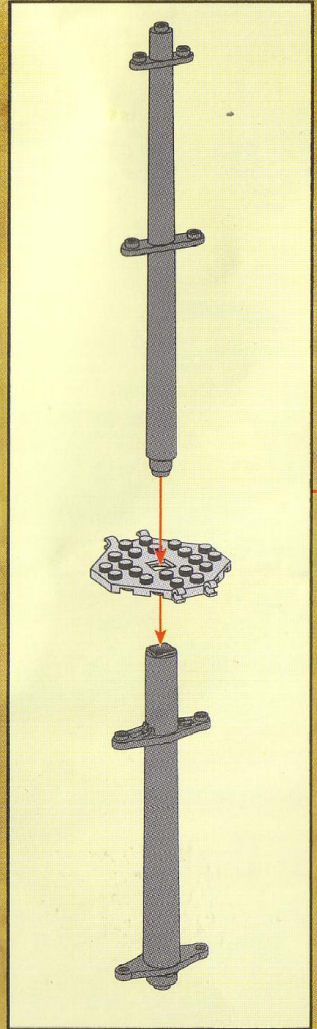



**4**

1X 1X 1X 1X 4X  
 2X 2X  
 2X  
 1X  
 1X  
 1X  
 1X  
 1X 1X  
 2X 1X

This block contains the parts list for step 4. It includes:
 

- 1x grey 1-hole Technic brick
- 1x grey 2-hole Technic brick
- 1x yellow 1-hole Technic brick
- 1x grey 2-hole Technic brick with a hole
- 4x yellow 1-hole Technic brick
- 2x grey 1-hole Technic brick with a hole
- 2x grey 2-hole Technic brick with a hole
- 2x grey 1-hole Technic brick
- 1x yellow 1-hole Technic brick
- 1x grey 1-hole Technic brick
- 1x grey 1-hole Technic brick
- 1x grey 1-hole Technic brick
- 1x grey hammer
- 1x grey hammer
- 2x brown 1-hole Technic grid
- 1x grey 1-hole Technic axle

1

2

This inset shows two sub-steps:
 

- Attaching a grey 1-hole Technic brick to the end of a grey 2-hole Technic brick.
- Attaching a grey 1-hole Technic brick to the hole of a grey 2-hole Technic brick.

1

2

3

This inset shows three sub-steps:
 

- Attaching a grey 1-hole Technic brick to the end of a grey 2-hole Technic brick.
- Attaching a grey 1-hole Technic brick to the hole of a grey 2-hole Technic brick.
- Attaching a grey 1-hole Technic brick to the hole of a grey 2-hole Technic brick.

1

2

3

This inset shows three sub-steps:
 

- Attaching a yellow 1-hole Technic brick to the end of a grey 2-hole Technic brick.
- Attaching a yellow 1-hole Technic brick to the hole of a grey 2-hole Technic brick.
- Attaching a yellow 1-hole Technic brick to the hole of a grey 2-hole Technic brick.

The main diagram illustrates the assembly of the ship's mast and rigging. A grey axle is inserted through a grey 1-hole Technic brick at the top of the mast. The mast is supported by a brown grid structure. The rigging consists of several grey 2-hole Technic bricks with holes, connected to the mast and the ship's deck. Red arrows indicate the placement of the parts shown in the insets. The ship's deck is made of grey Technic bricks and features a green door, a barrel, and other details.







6

1X 1X 1X 1X  
 2X 2X  
 1X 1X  
 1X  
 1X  
 1X  
 1X  
 1X  
 1X  
 2X 2X  
 1X 2X  
 2X

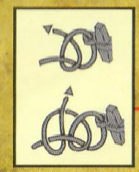
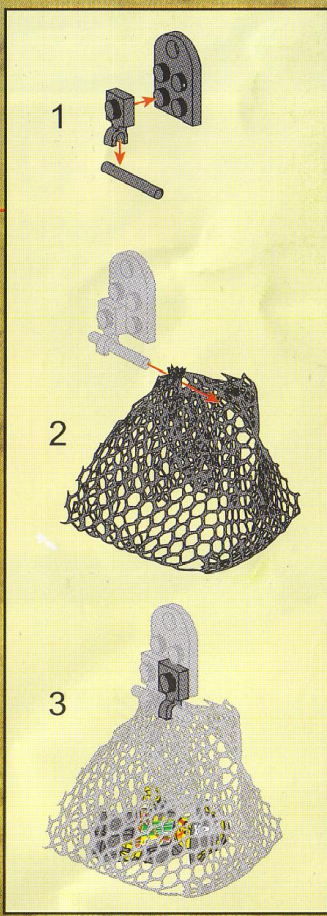
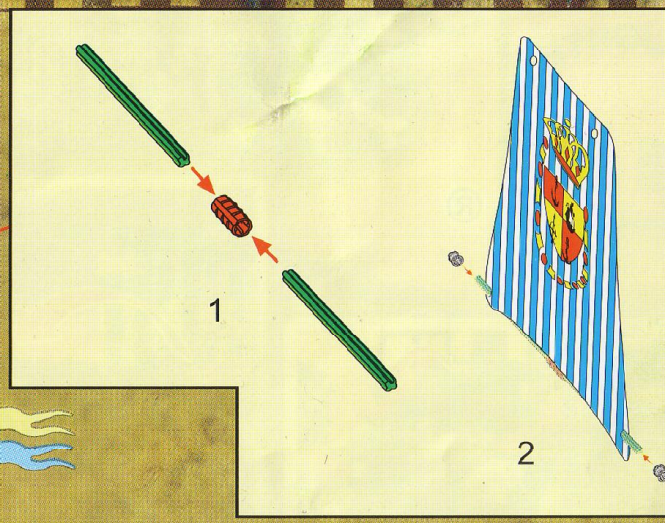
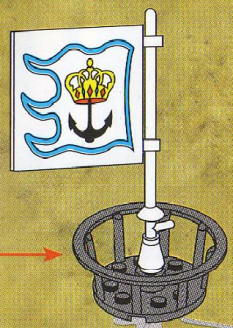
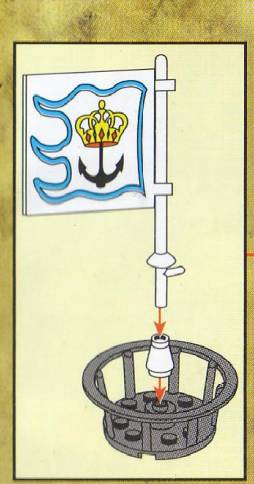



ENLIGHTEN  
啟蒙



Pirates  
Series

®

