

BOEING 767™



WARNING: CHOKING HAZARD-
Toy contains small parts.
Not for children under 3 years.



Produced under license from
Boeing Management
Company.
767, 787, Dreamliner and
Boeing are among the
trademarks owned by
Boeing.



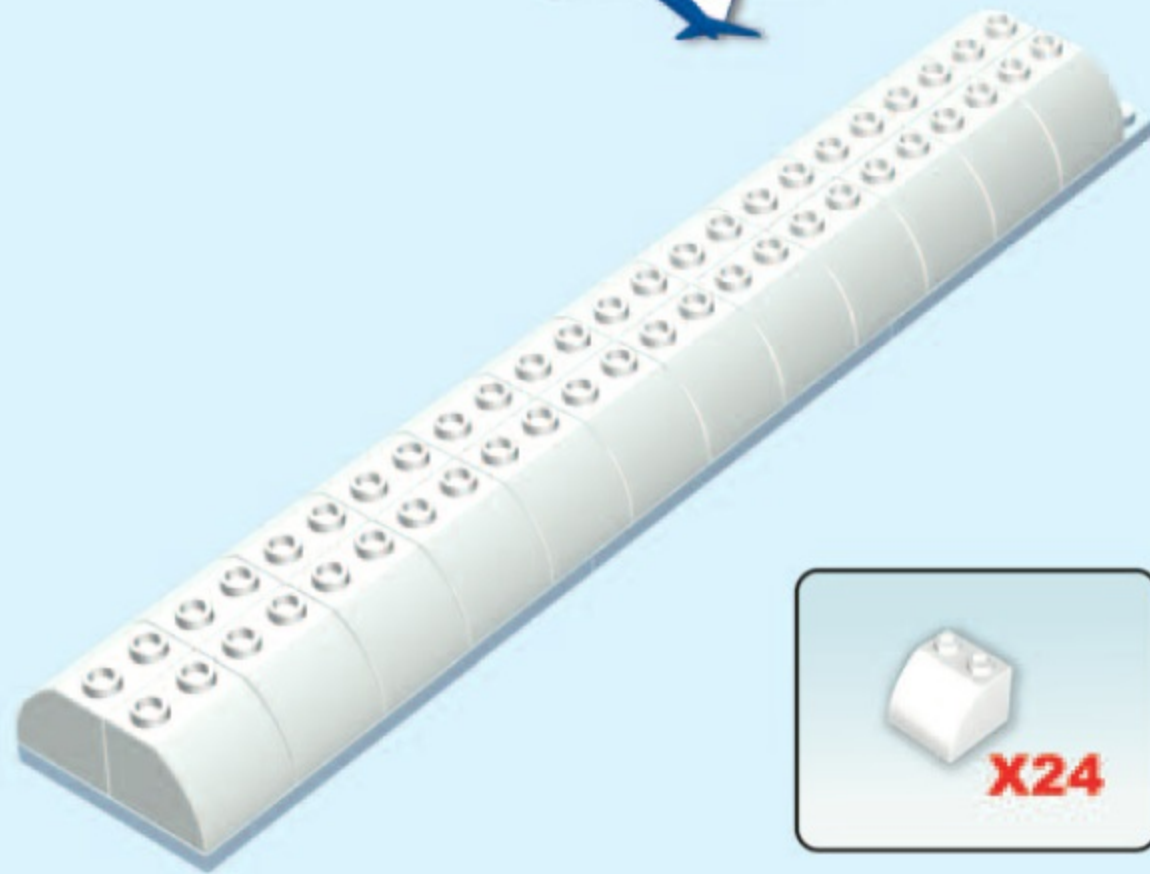
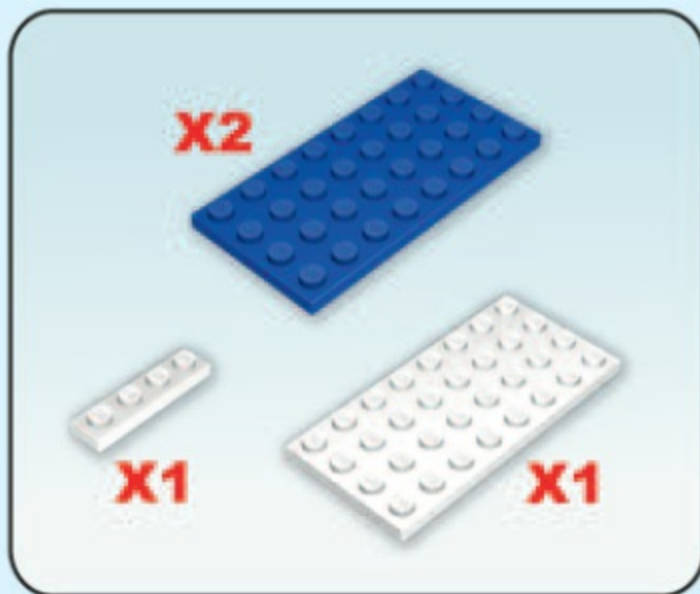
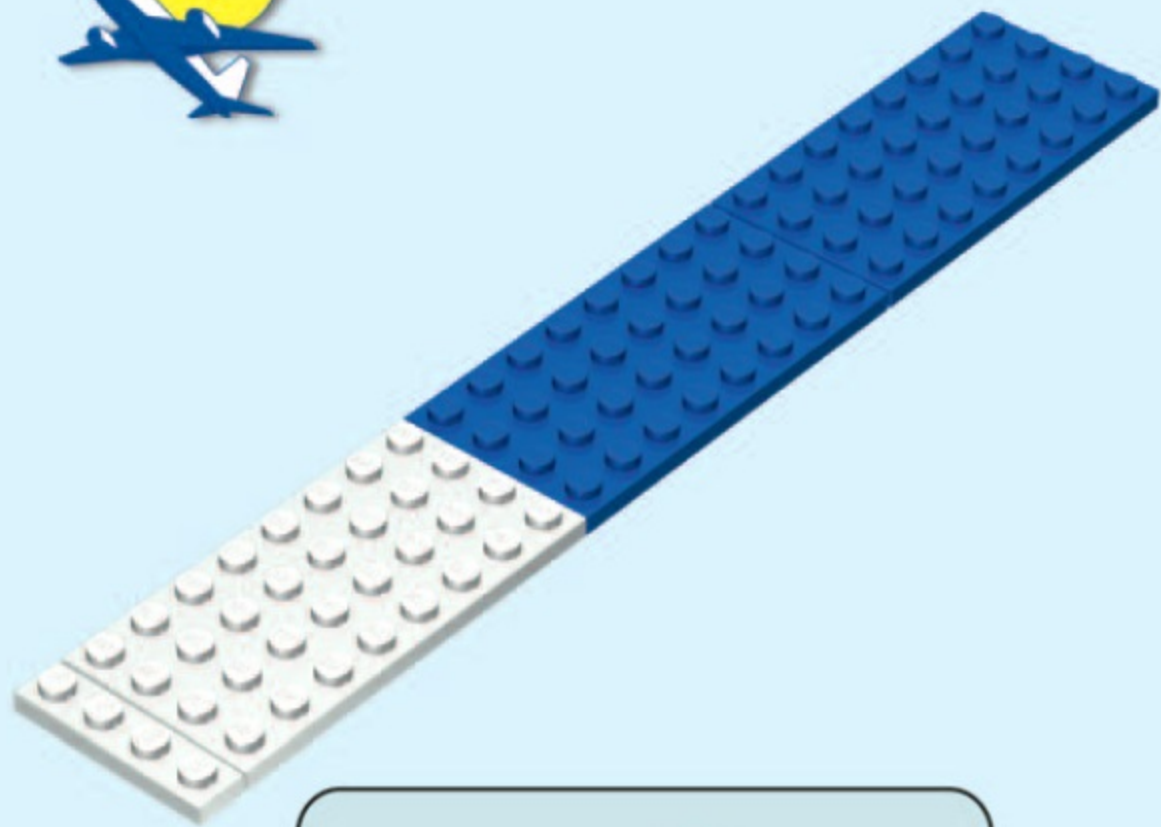

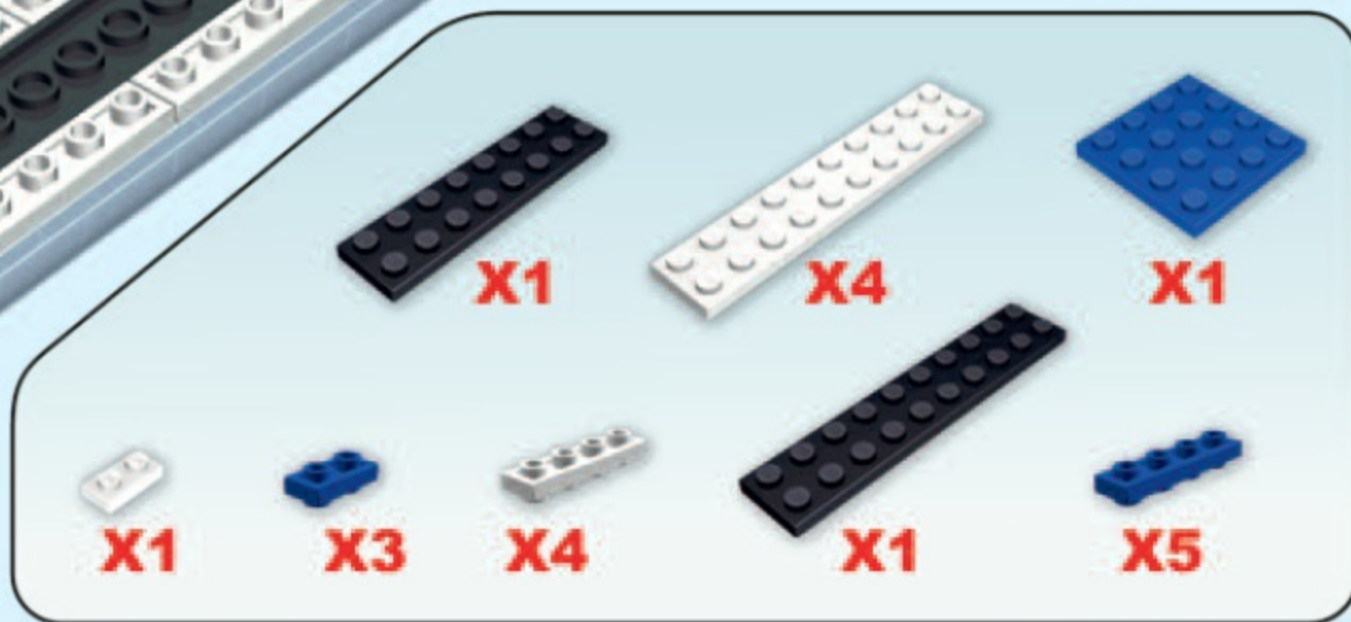
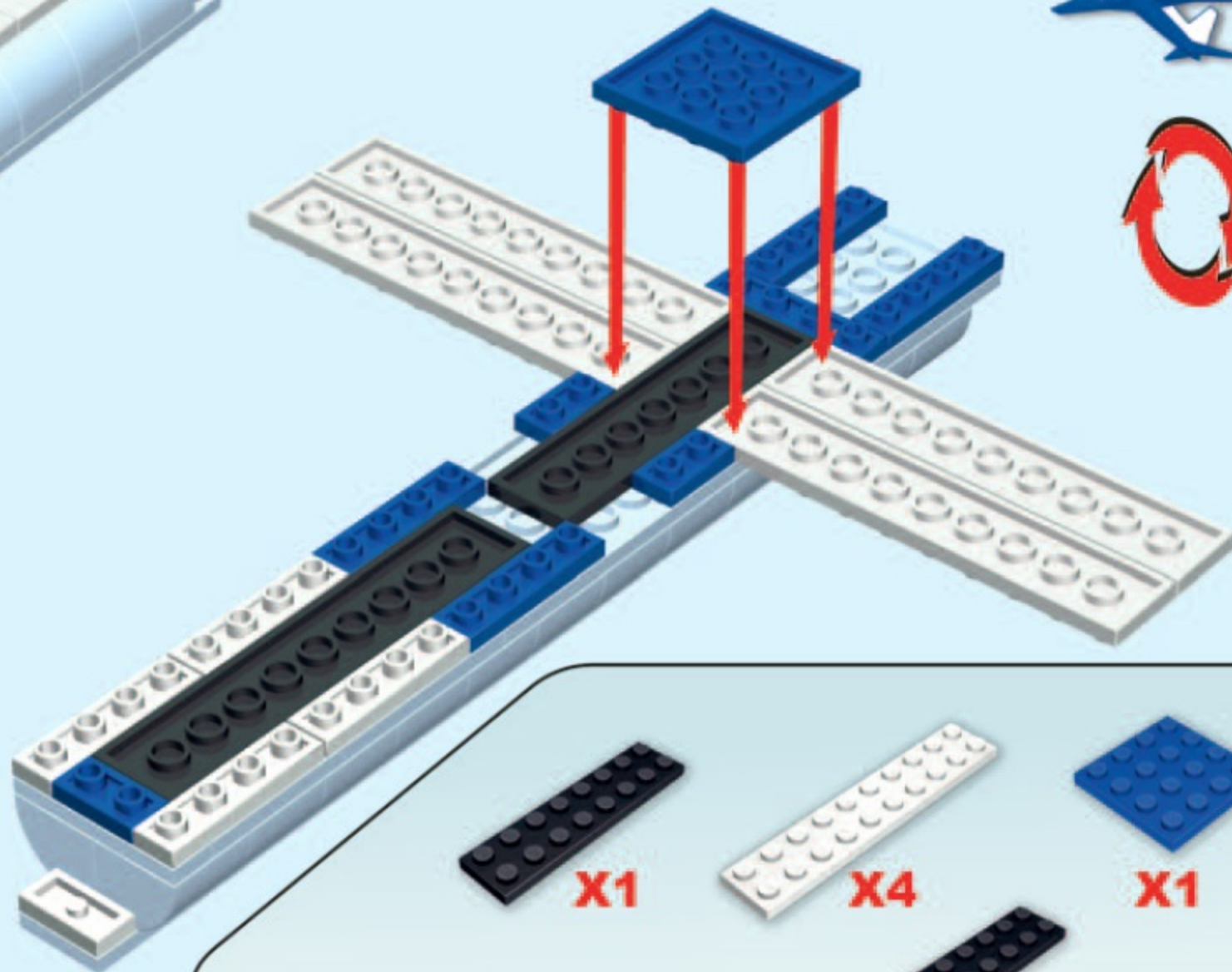

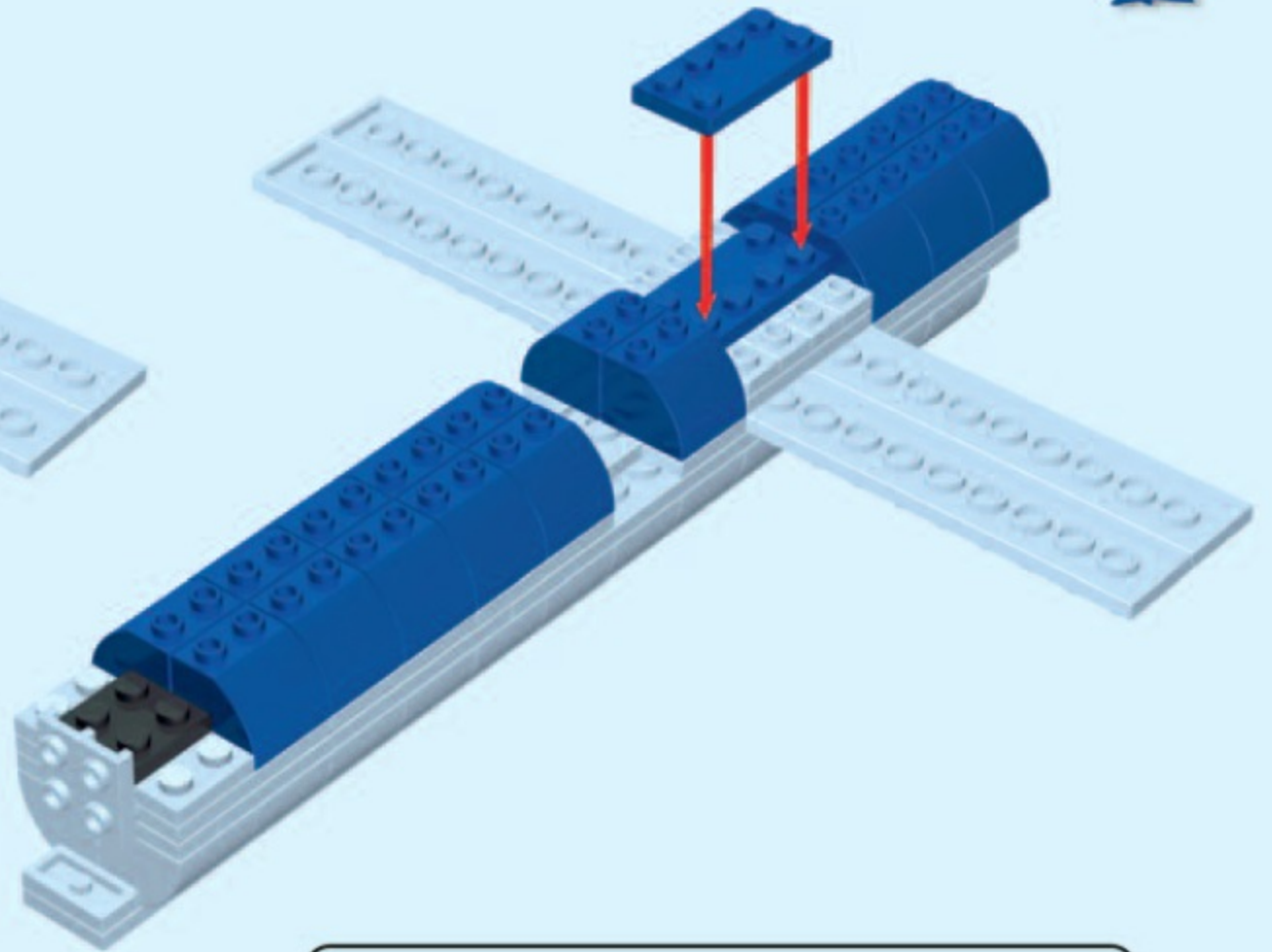
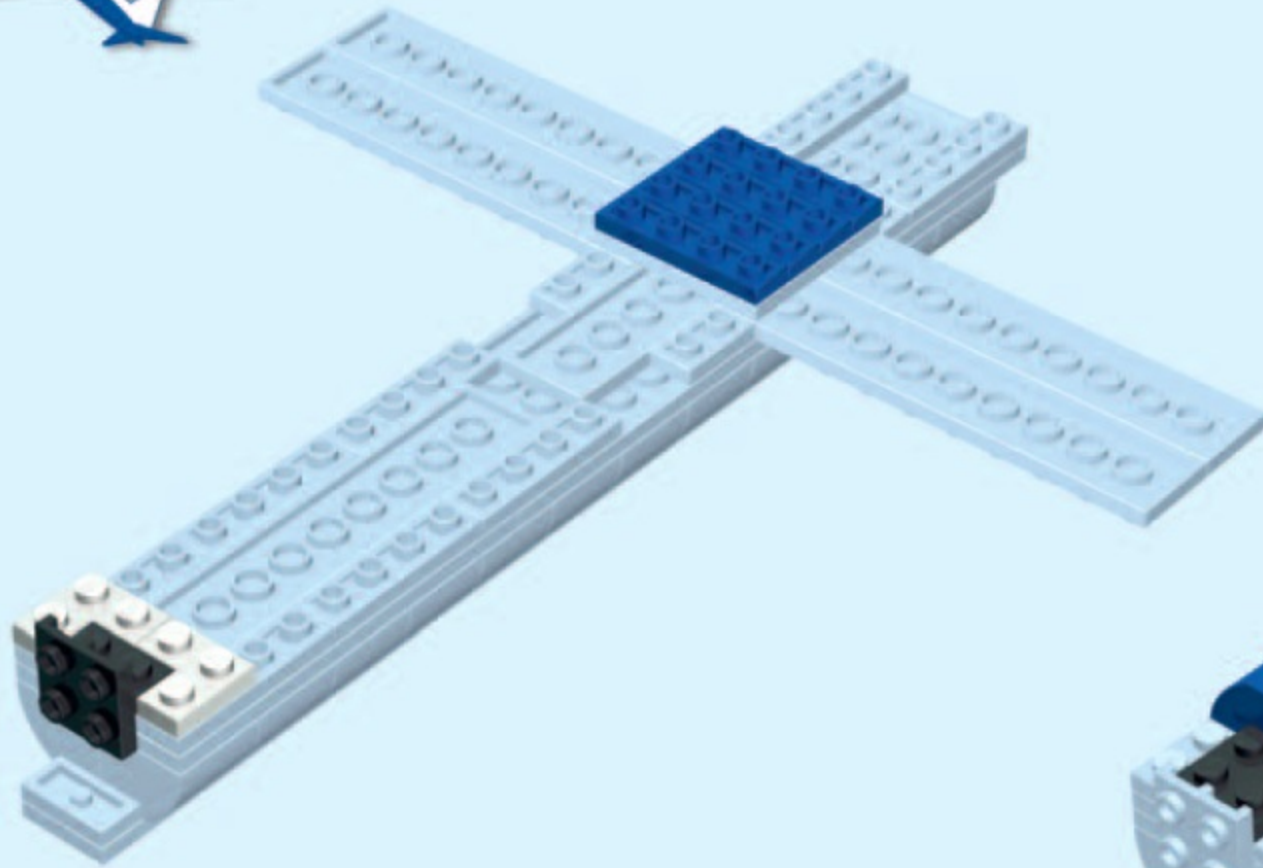

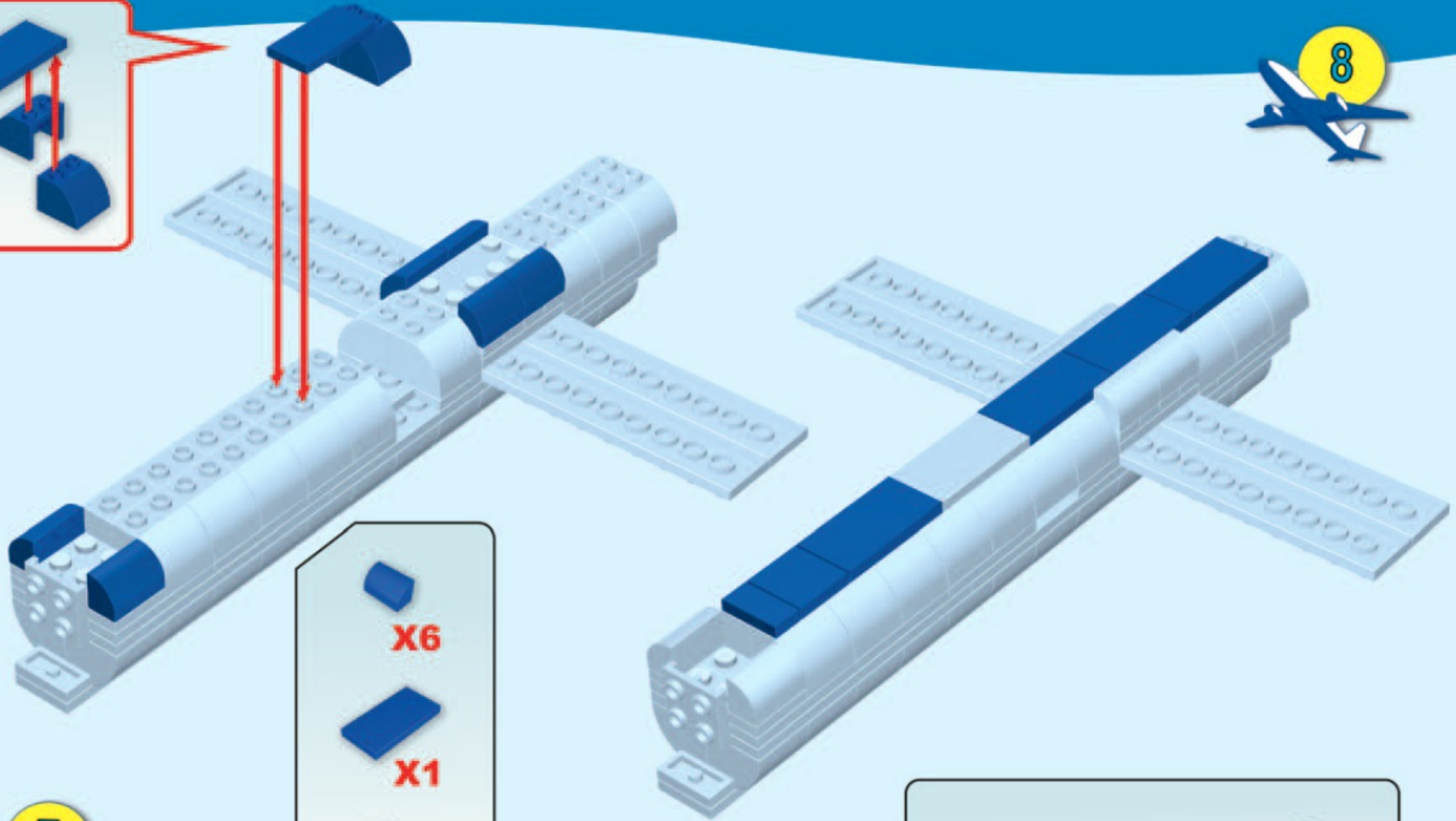

B

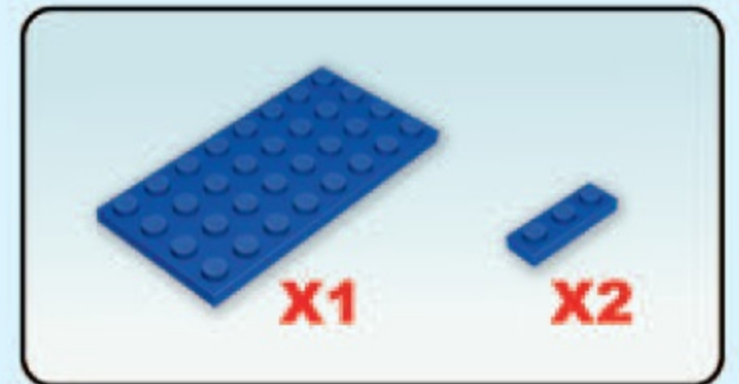
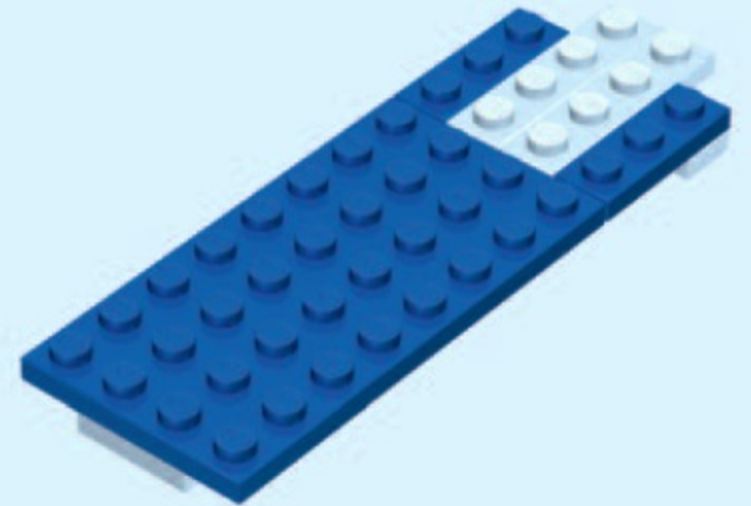
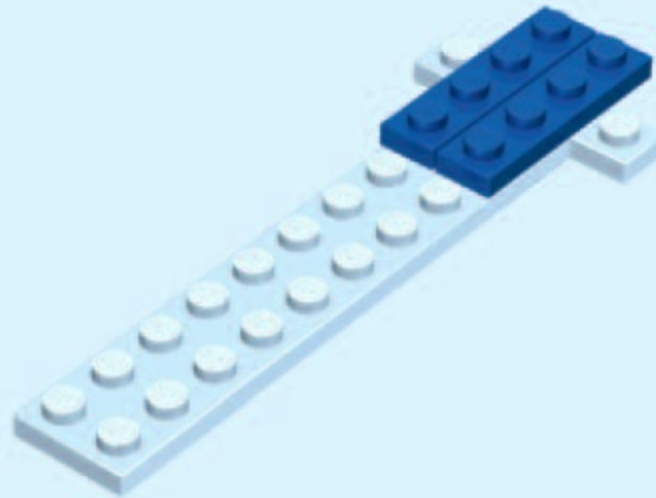
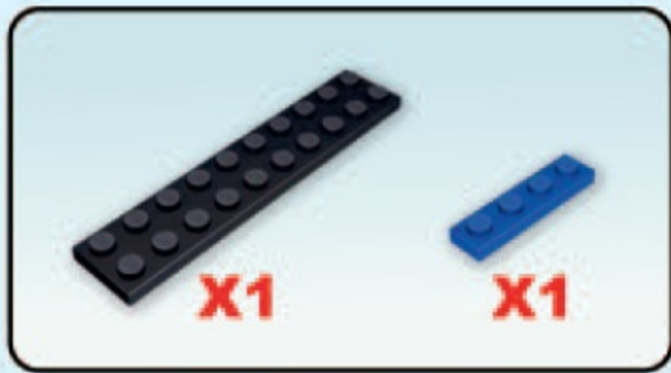
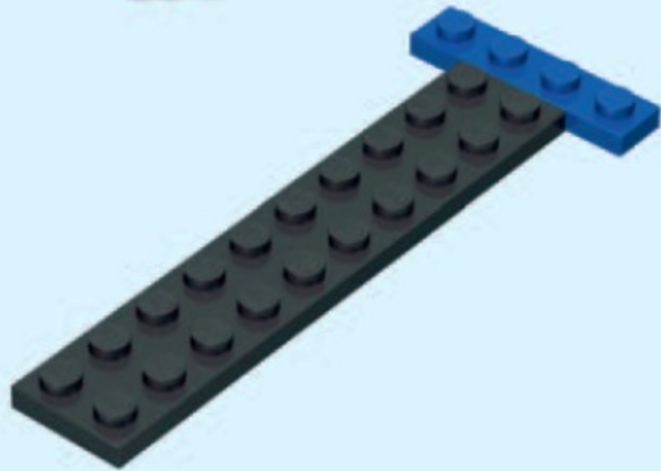

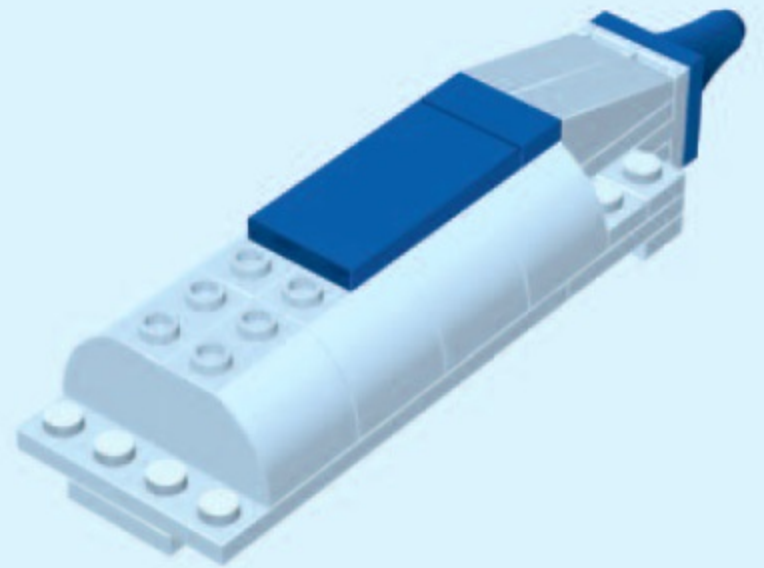
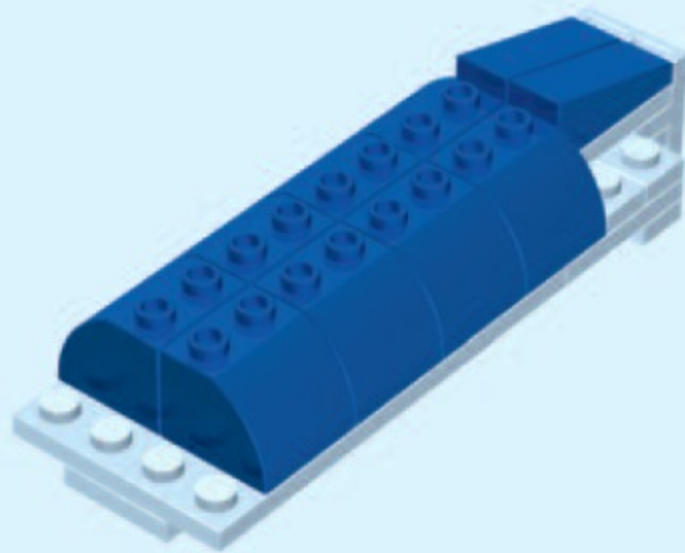
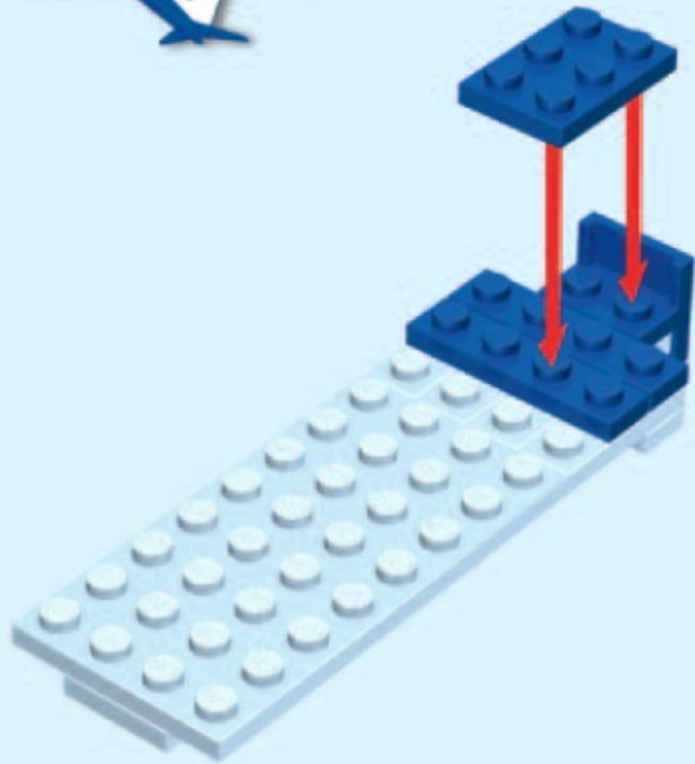

A

15

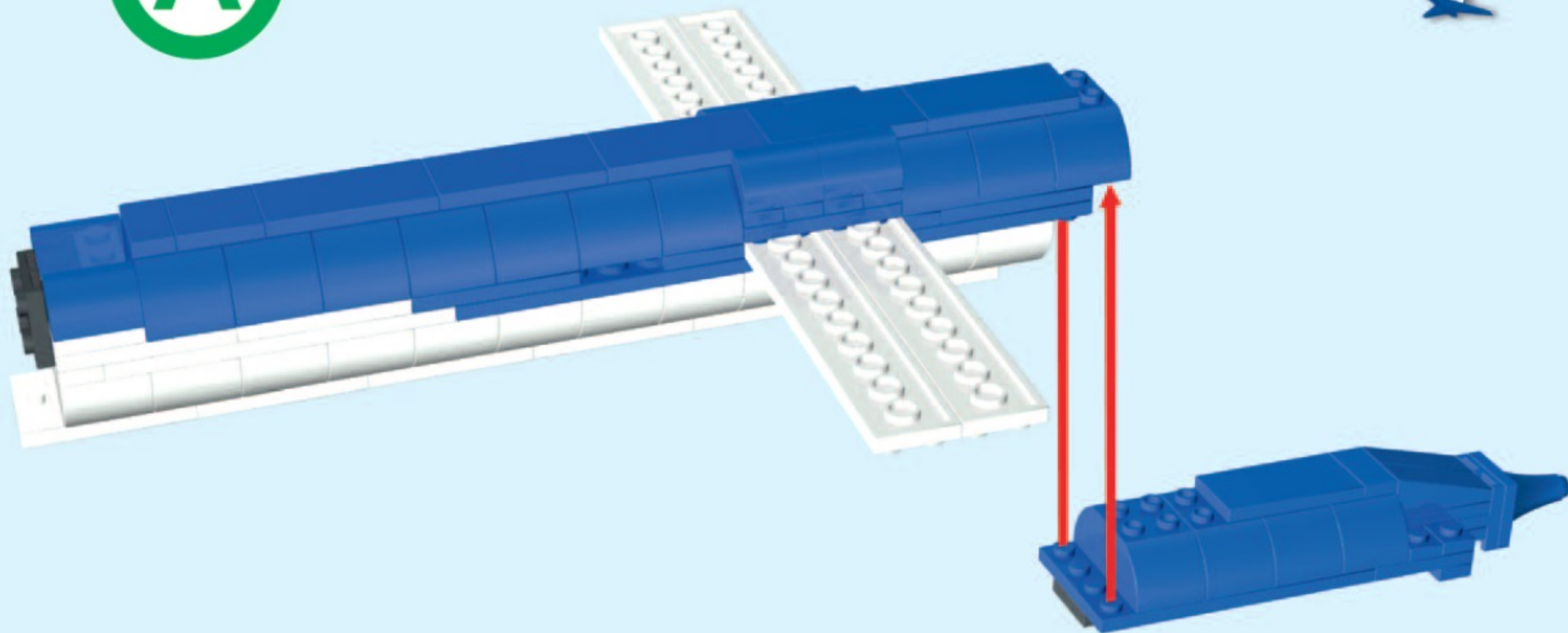

B

16

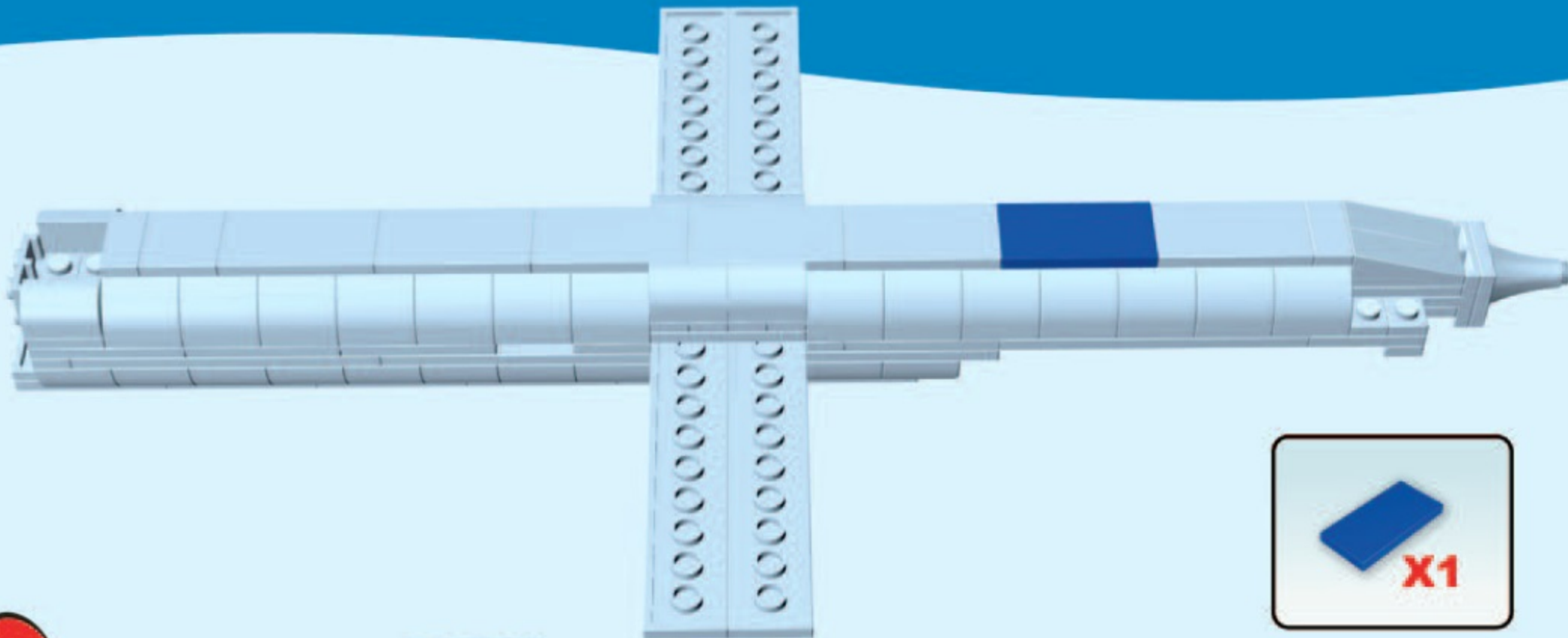

17

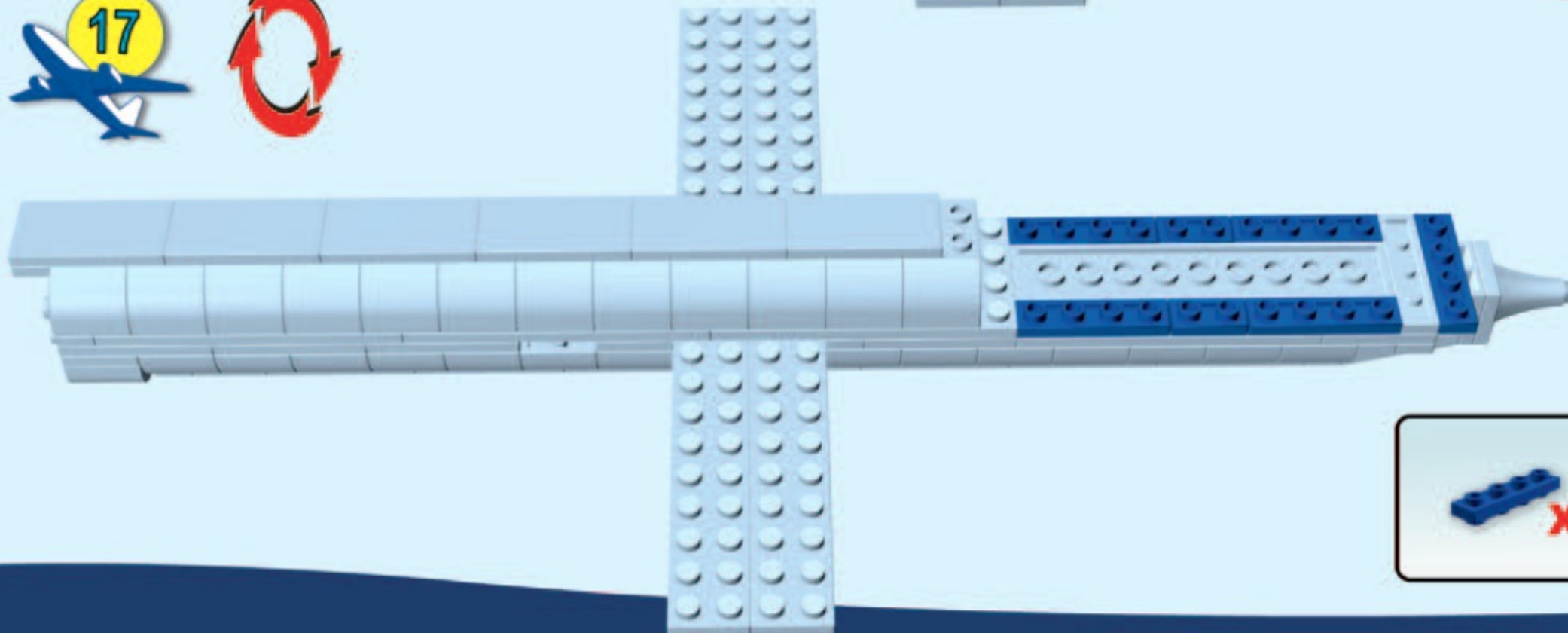

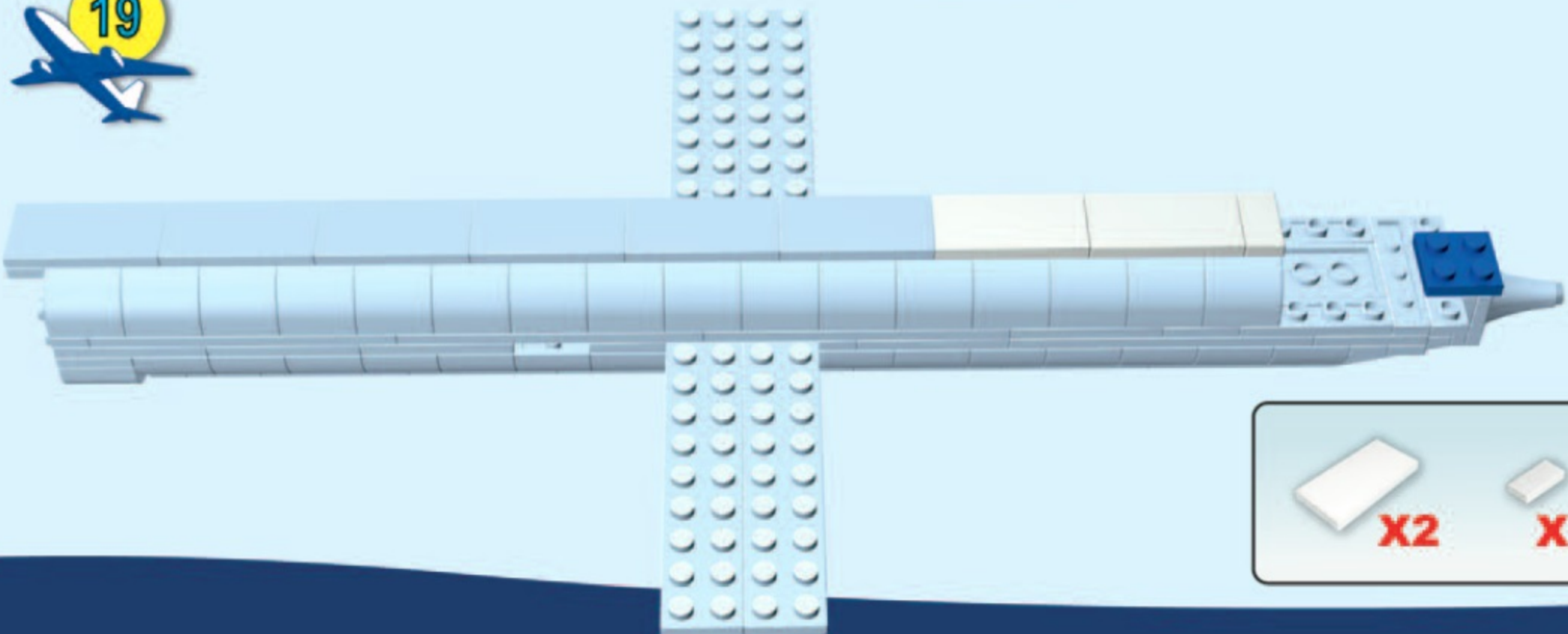
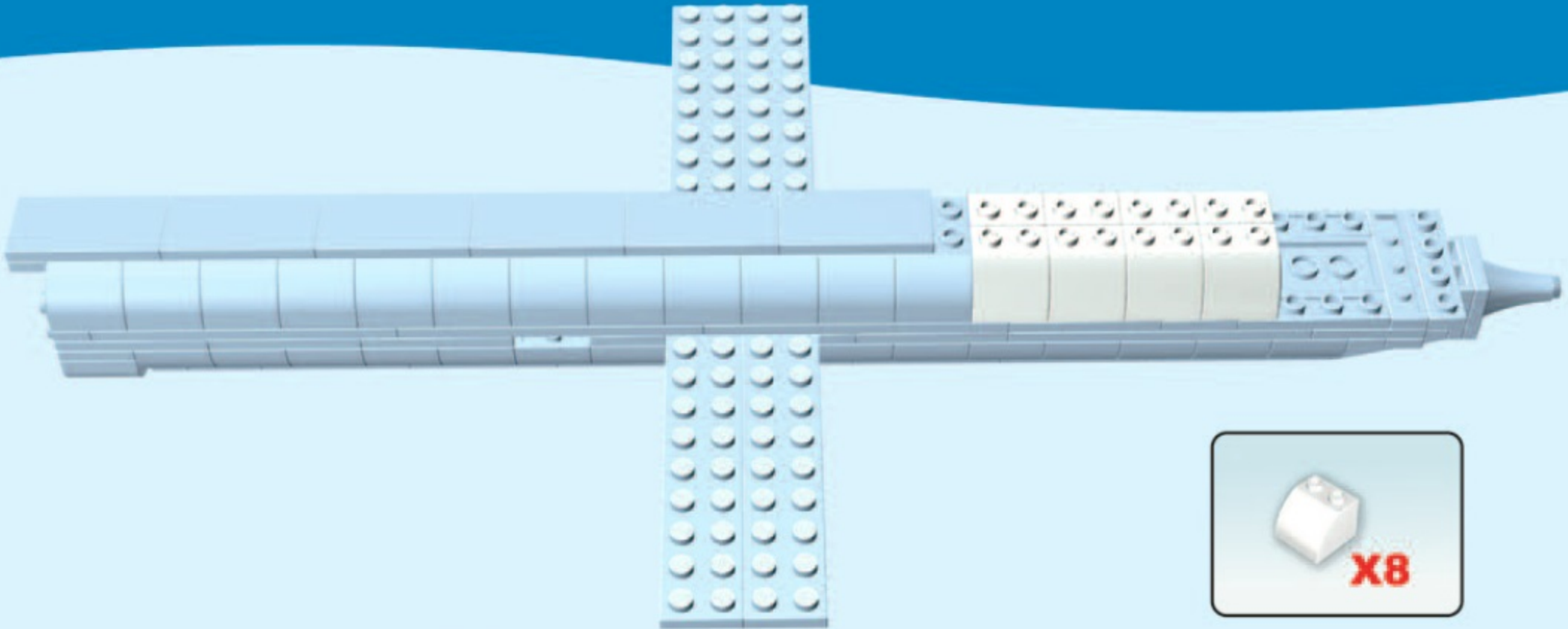



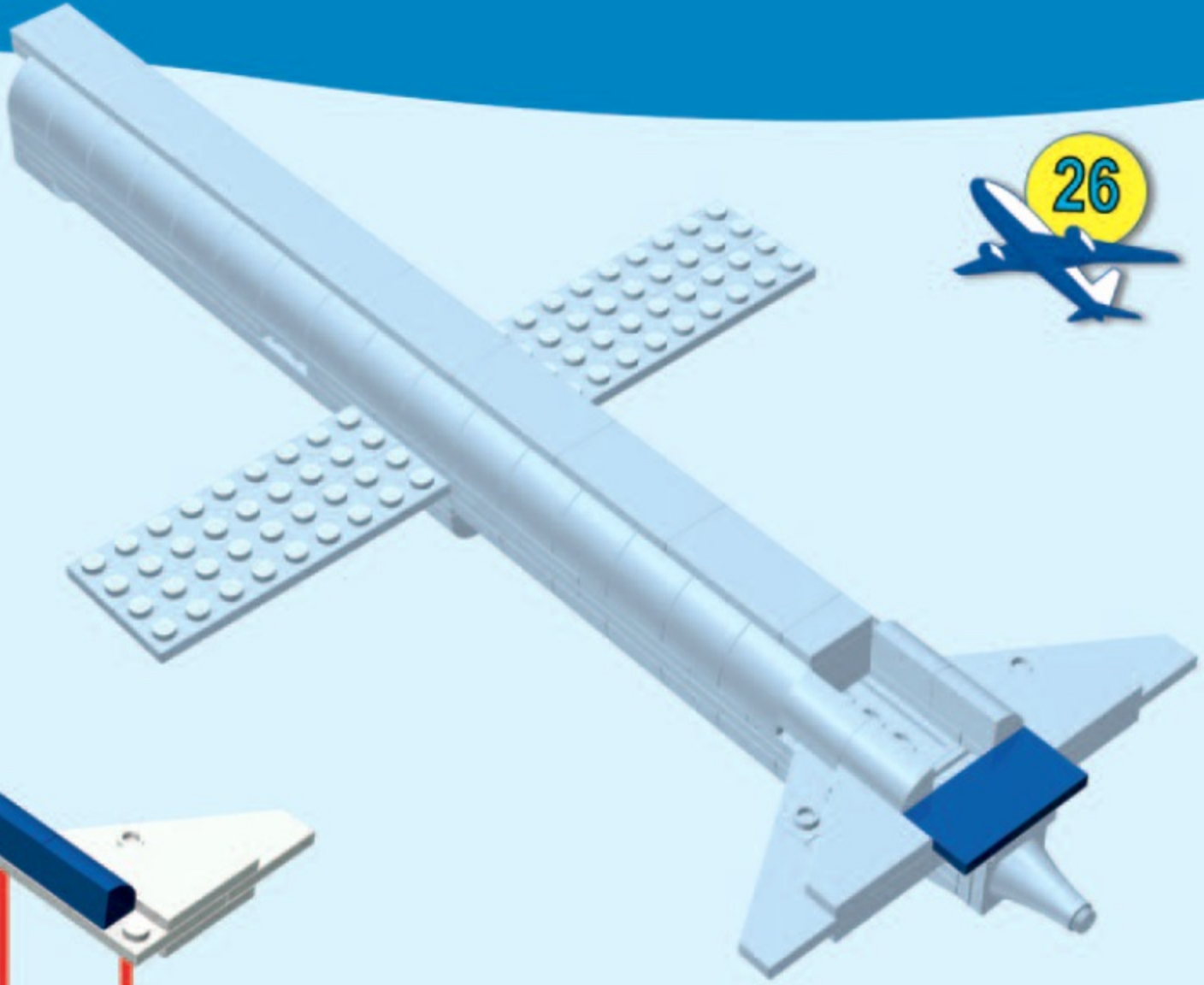
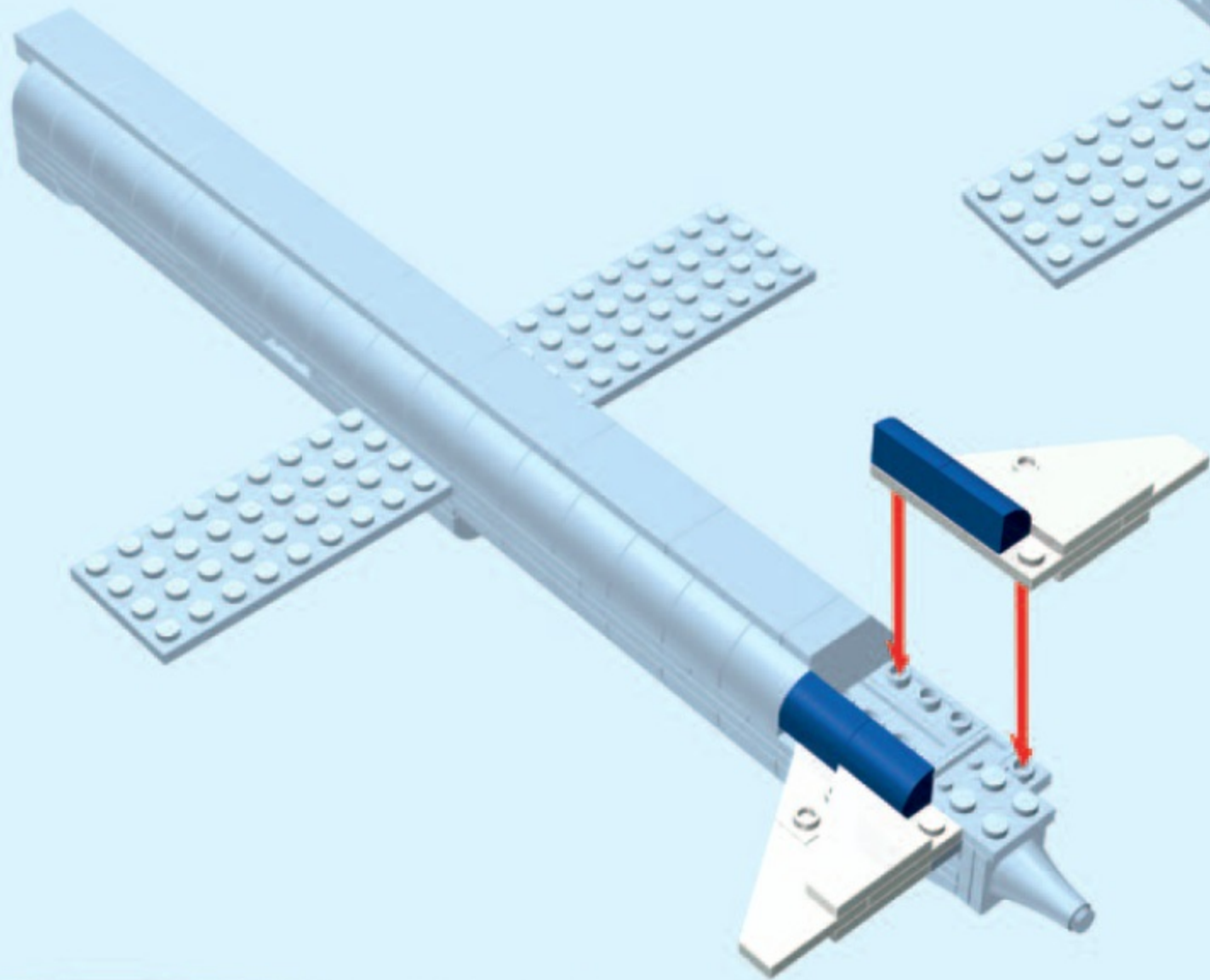

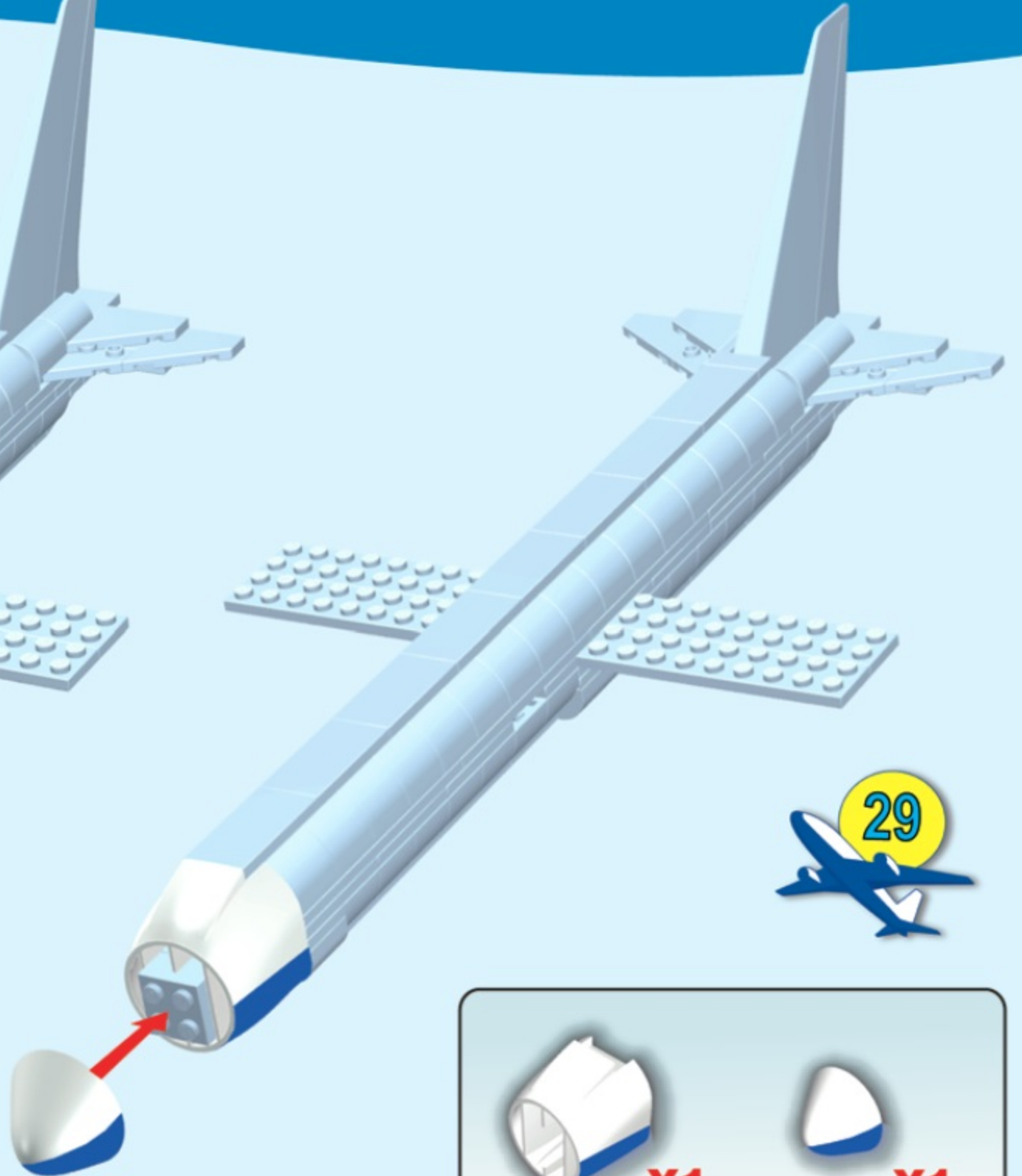
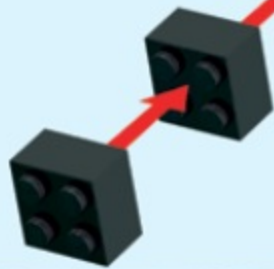
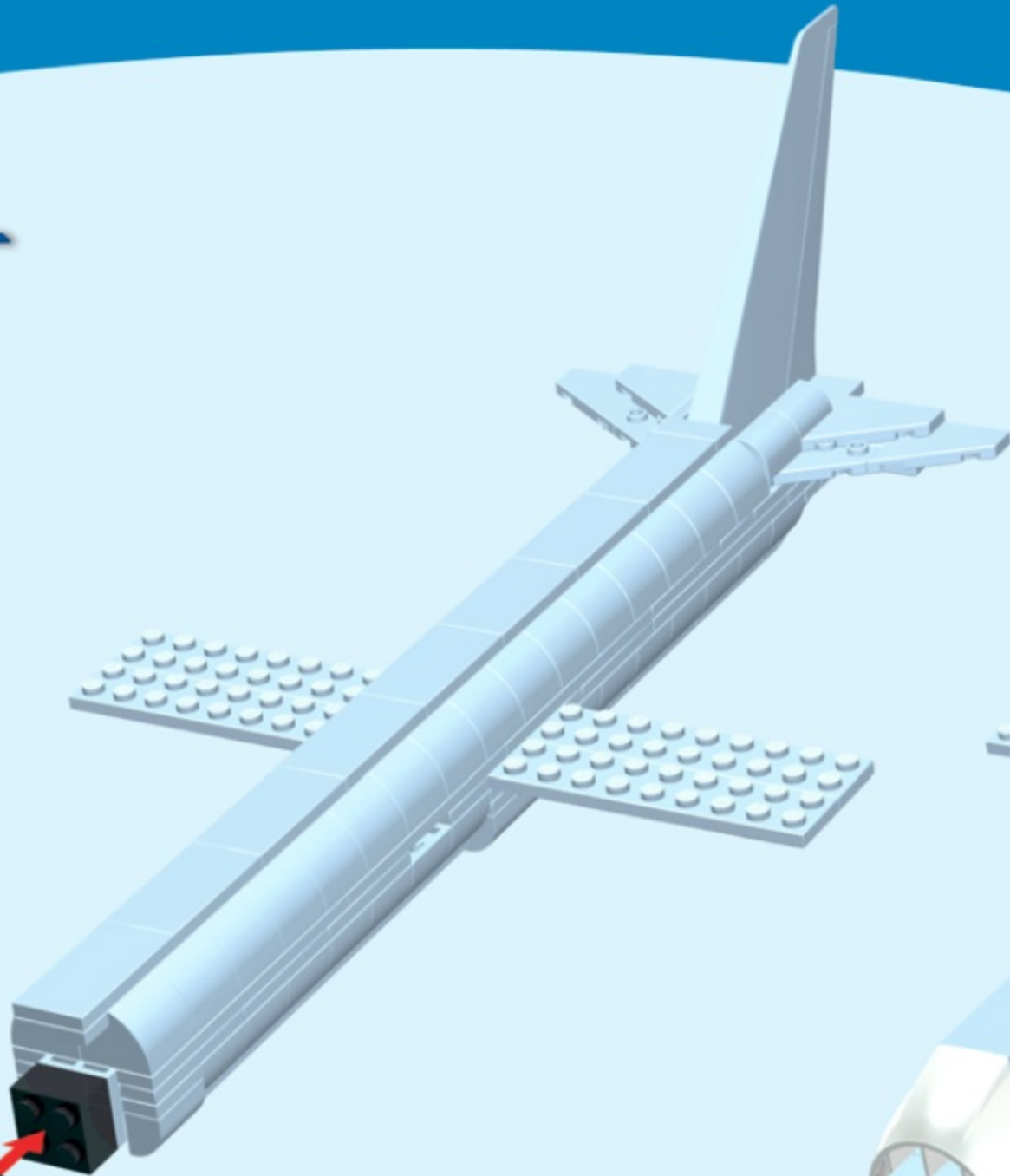

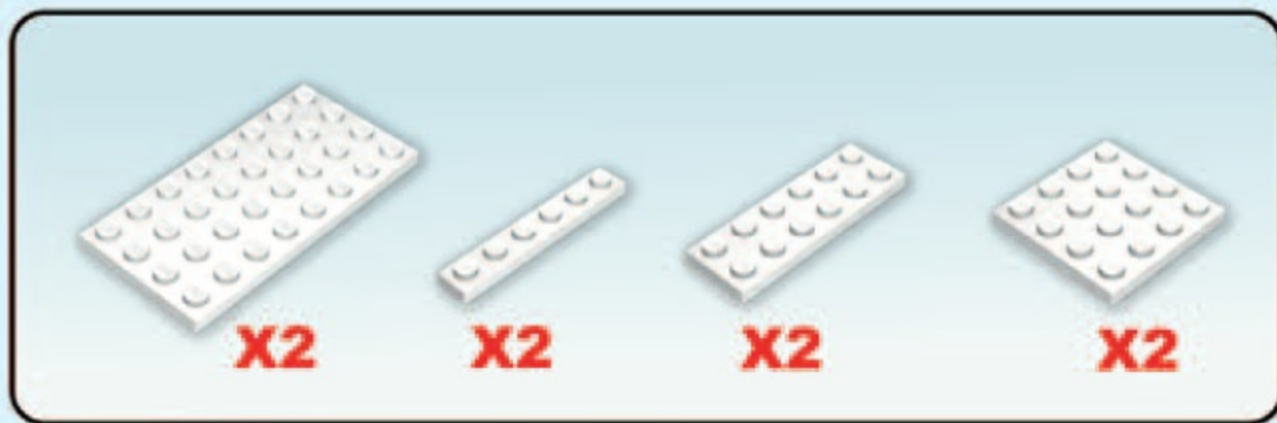
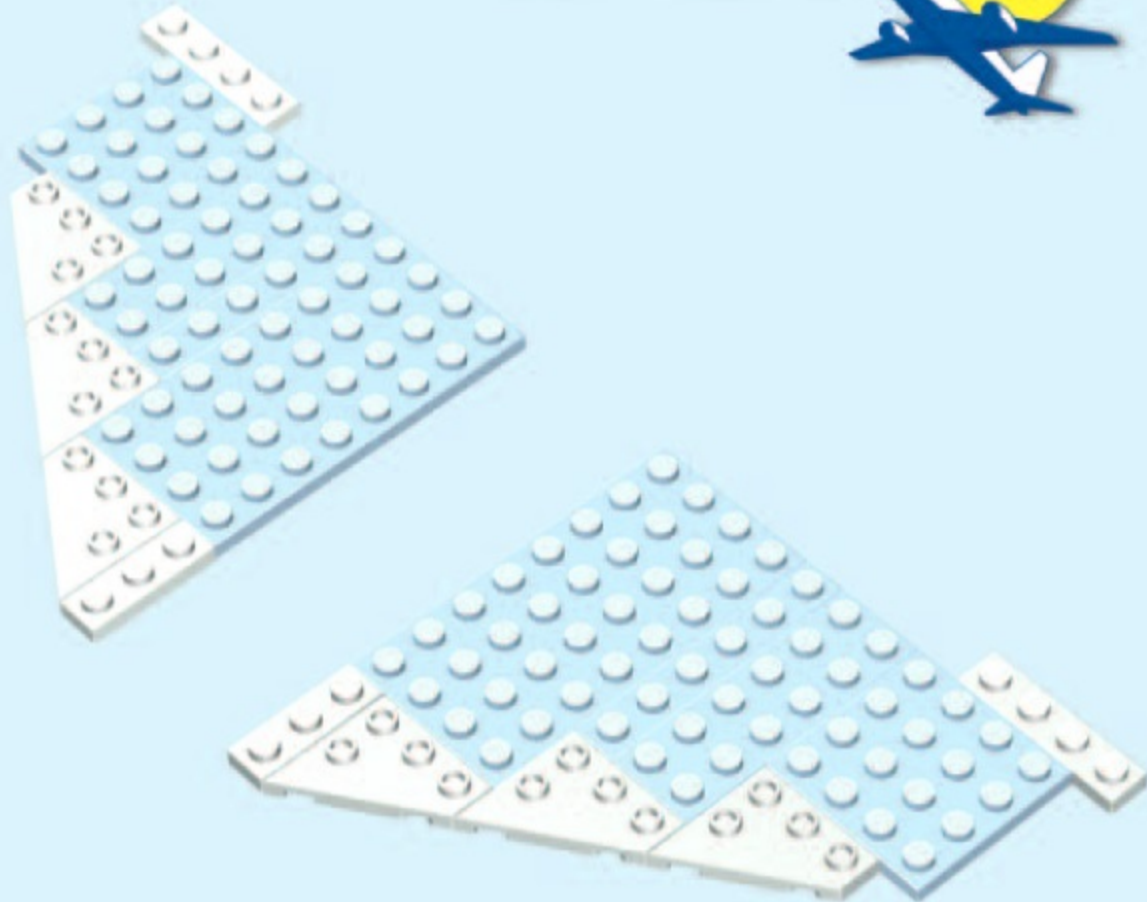
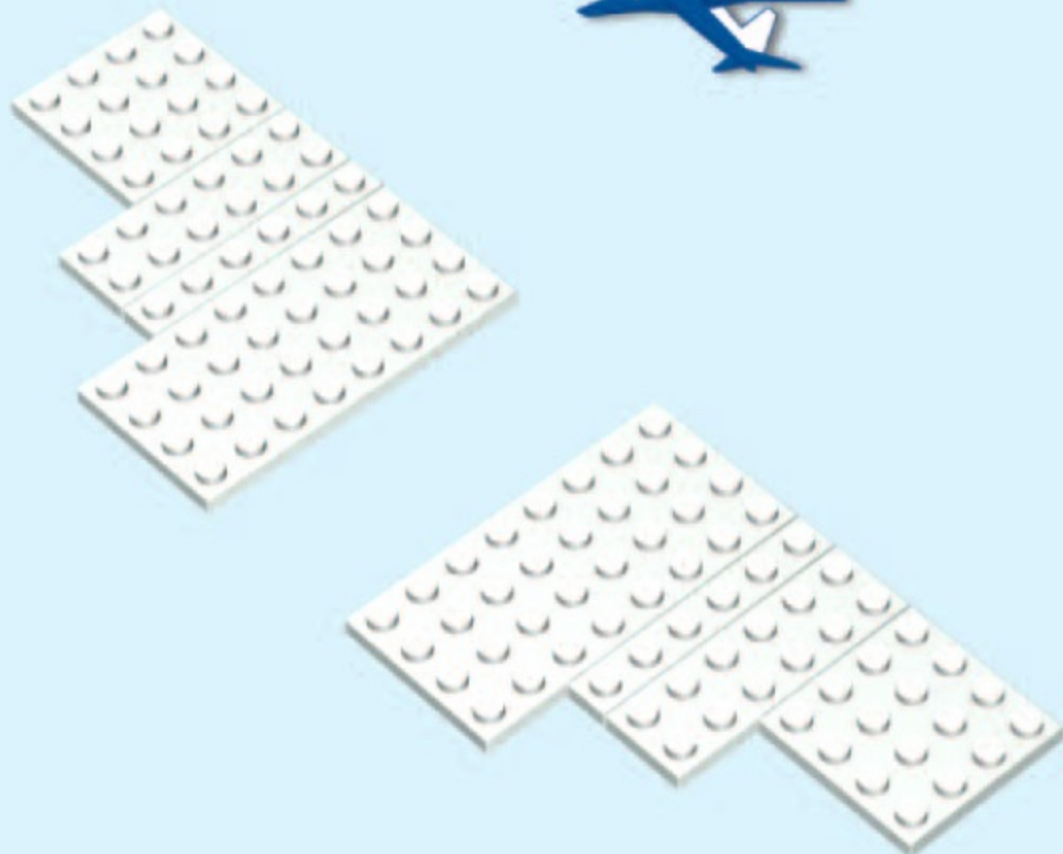

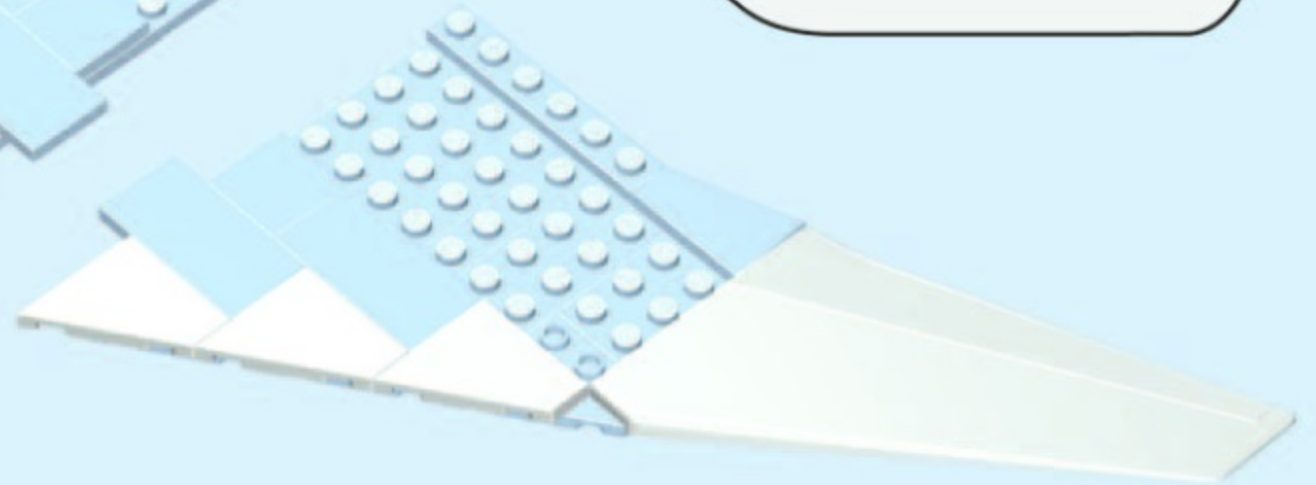
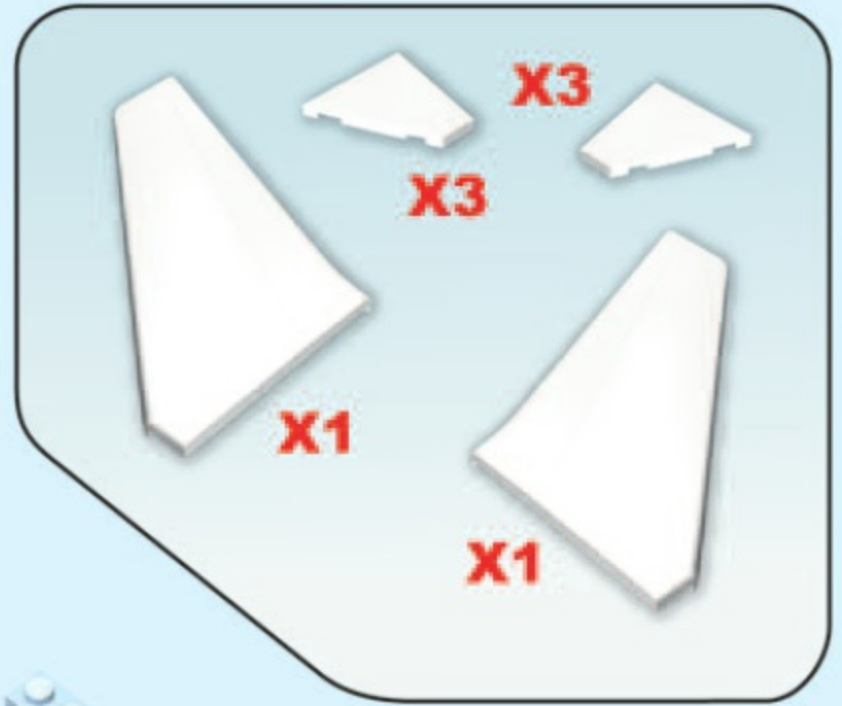
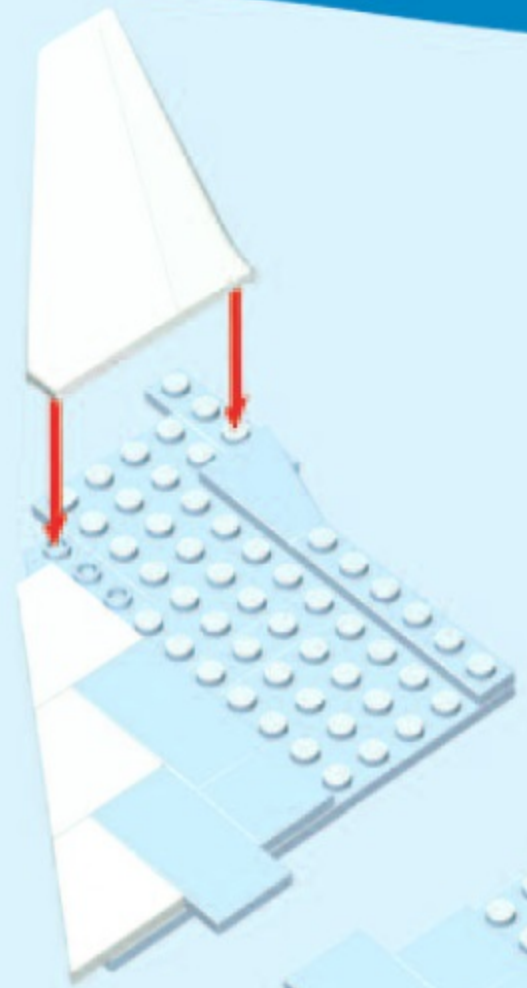
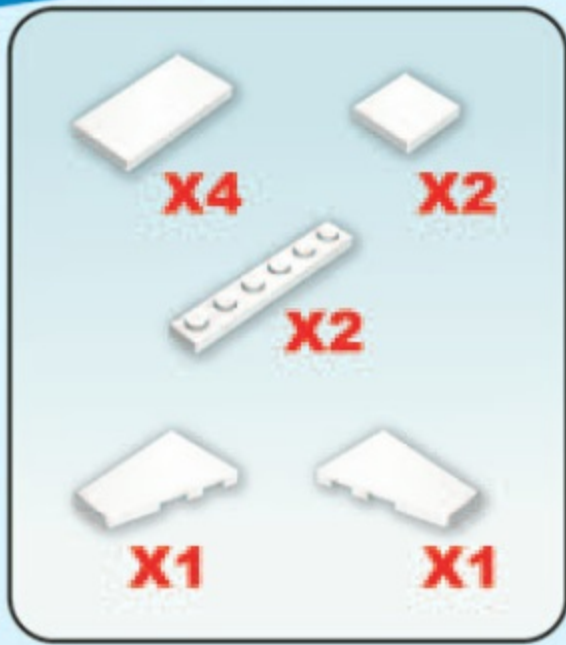

34

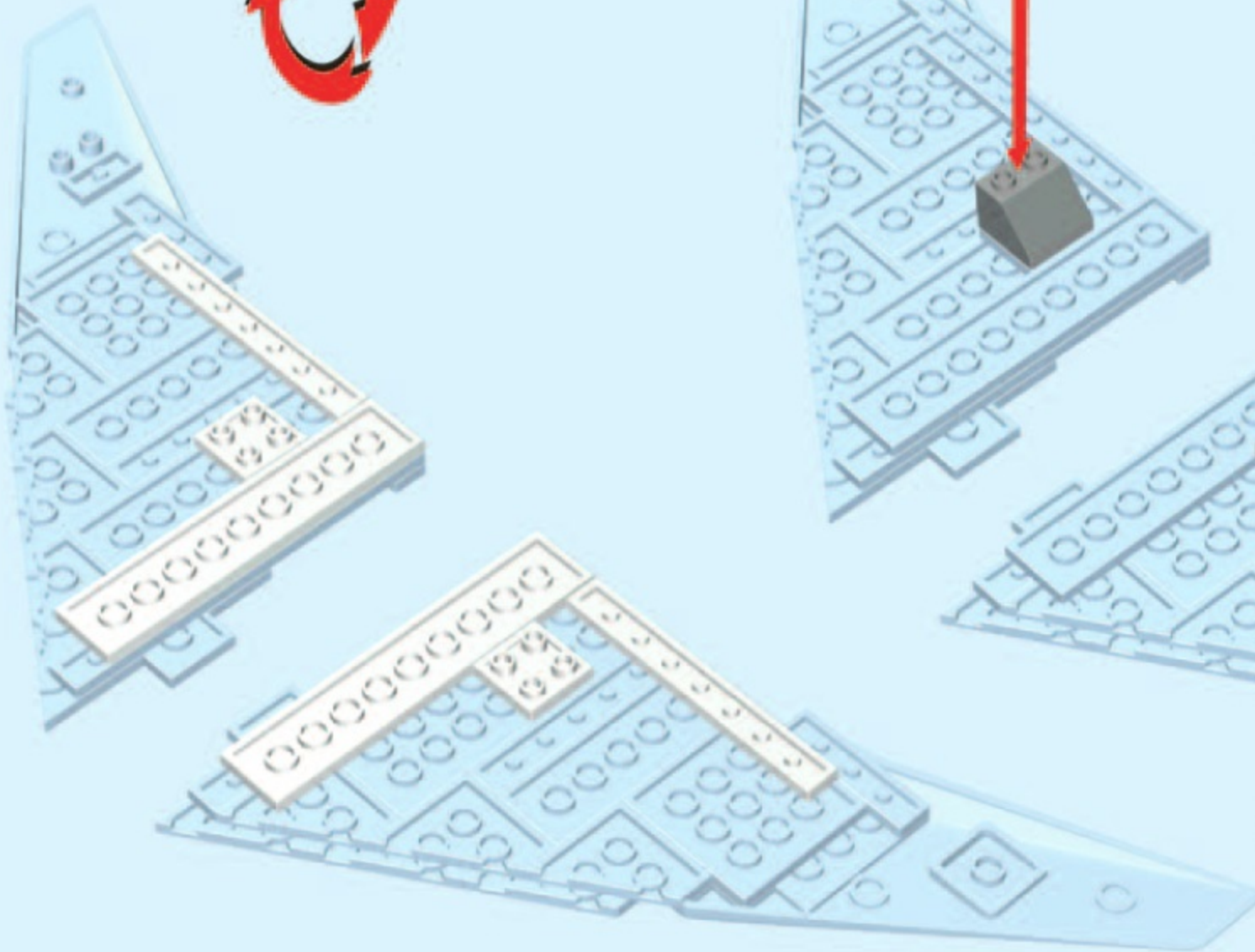

35

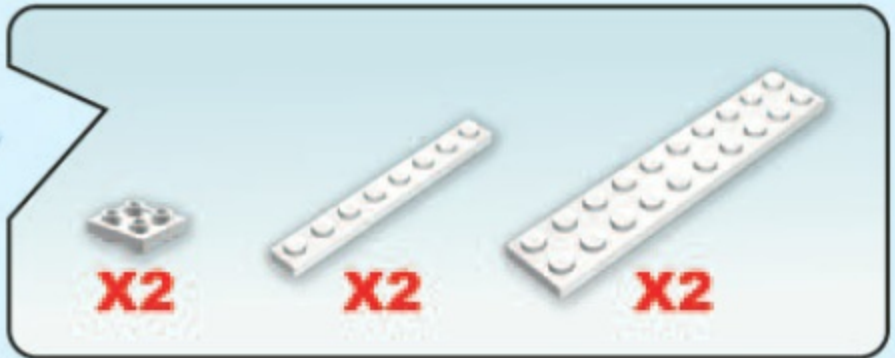
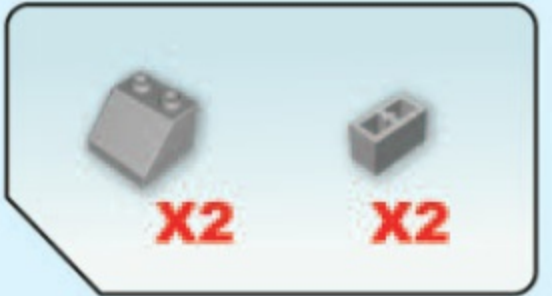
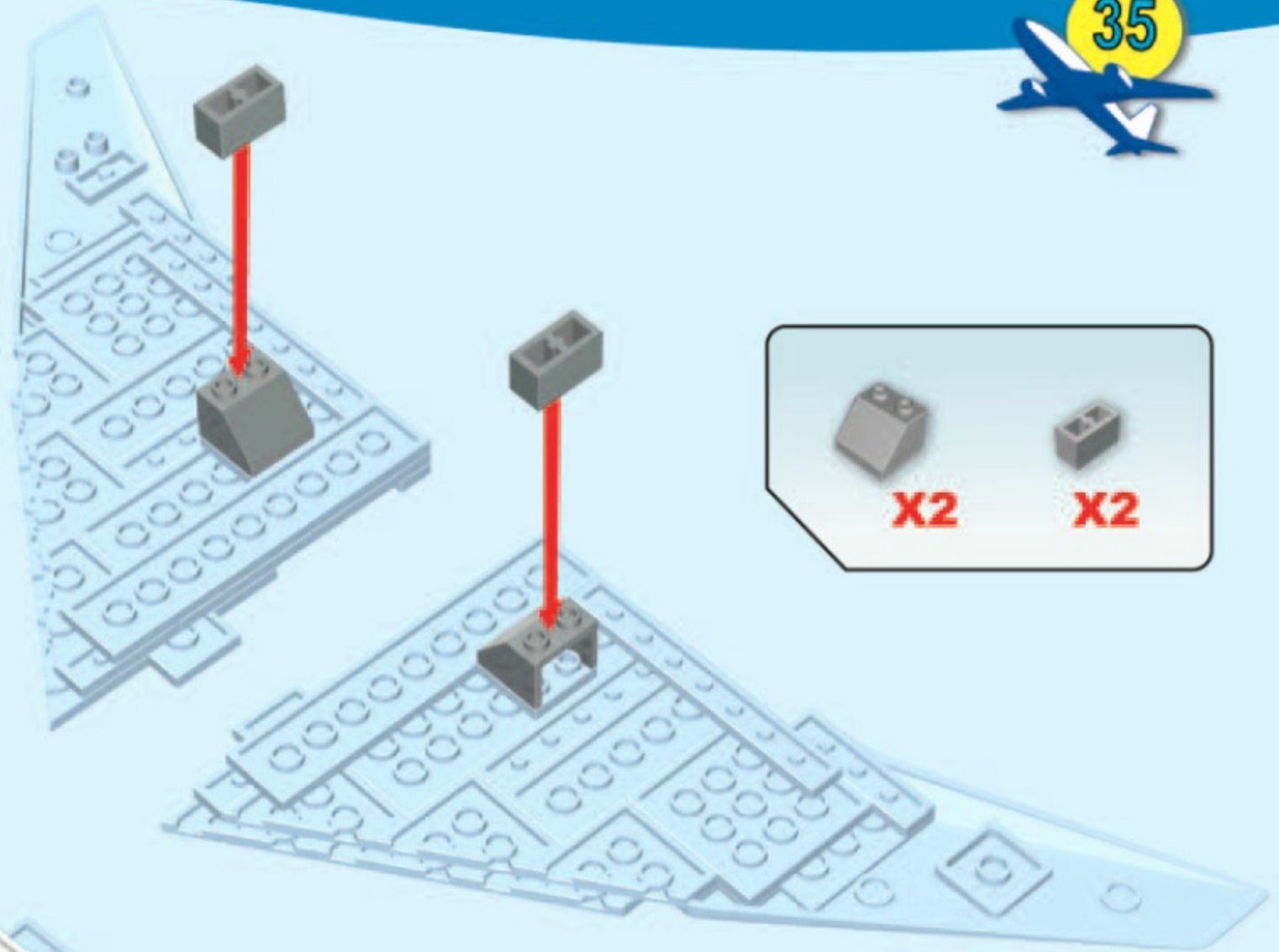



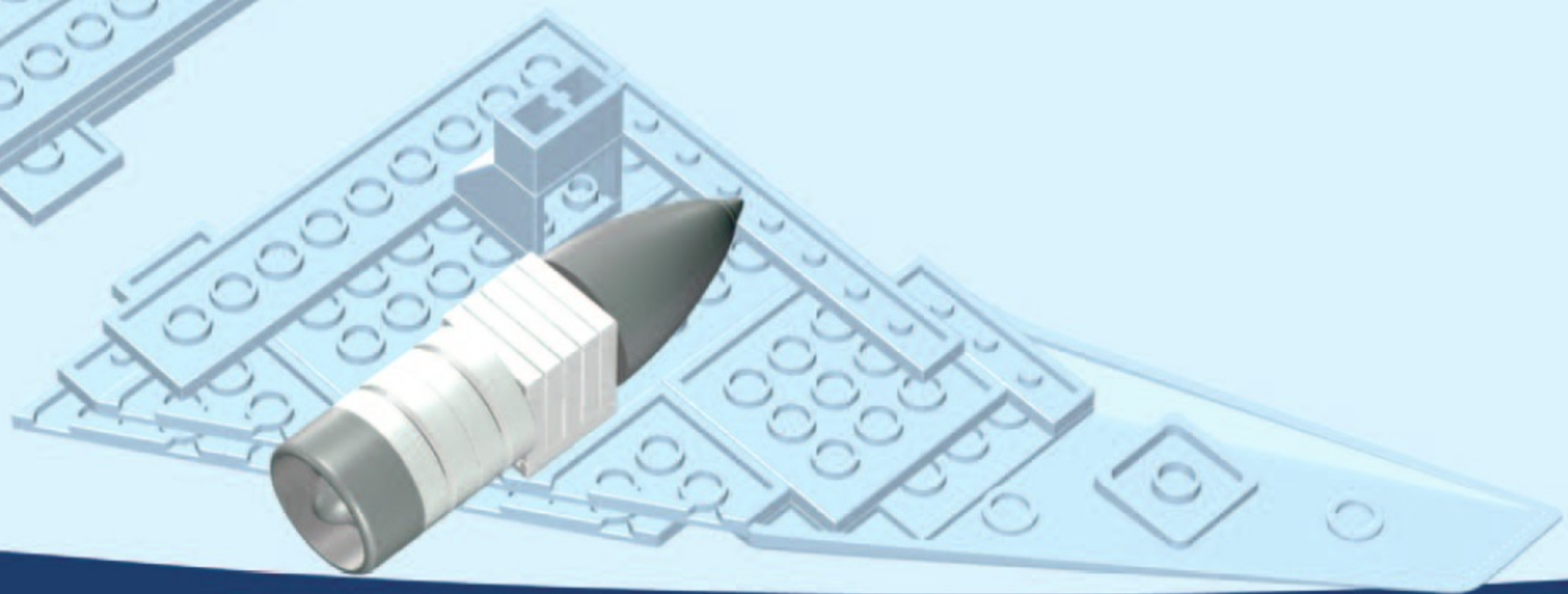
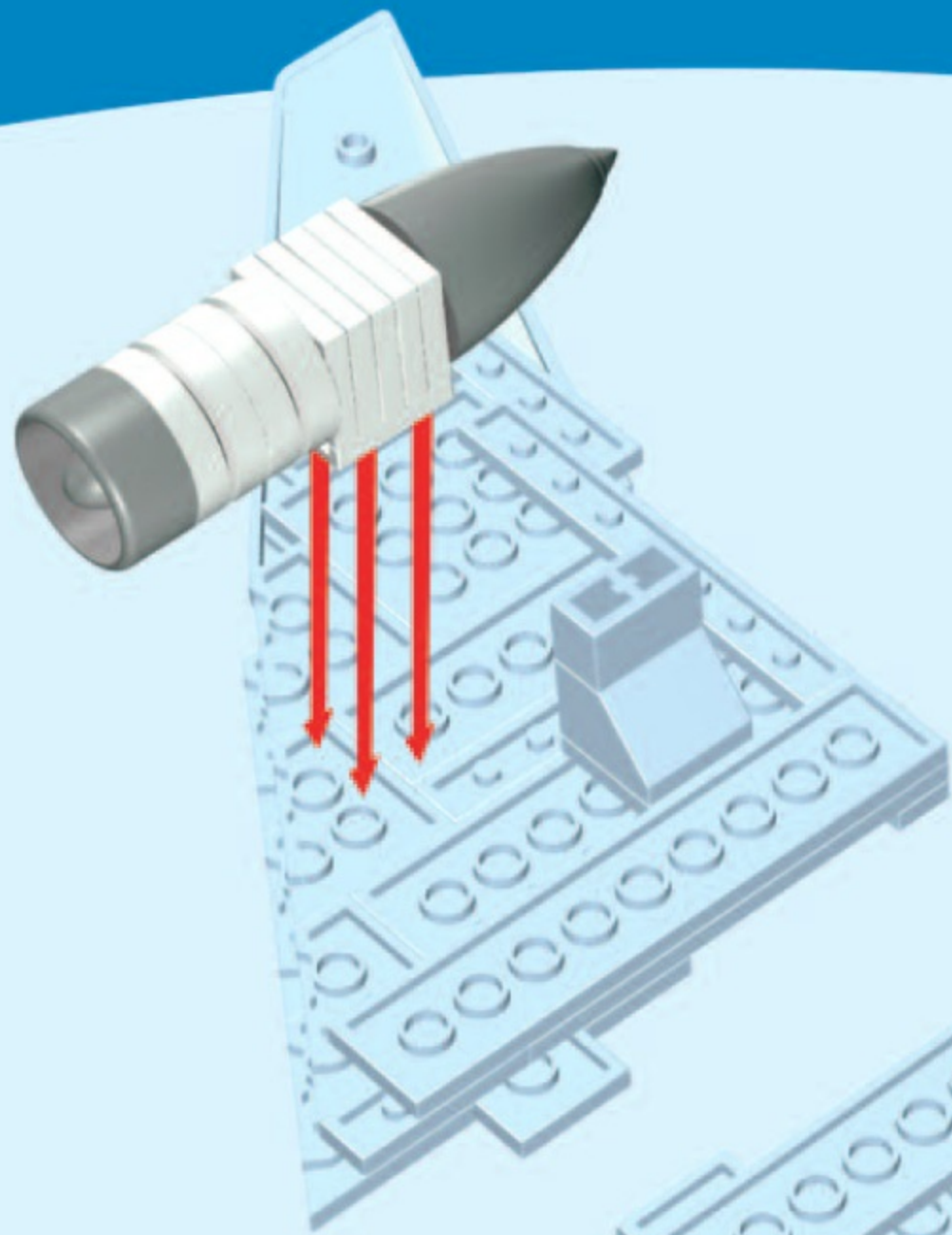

42



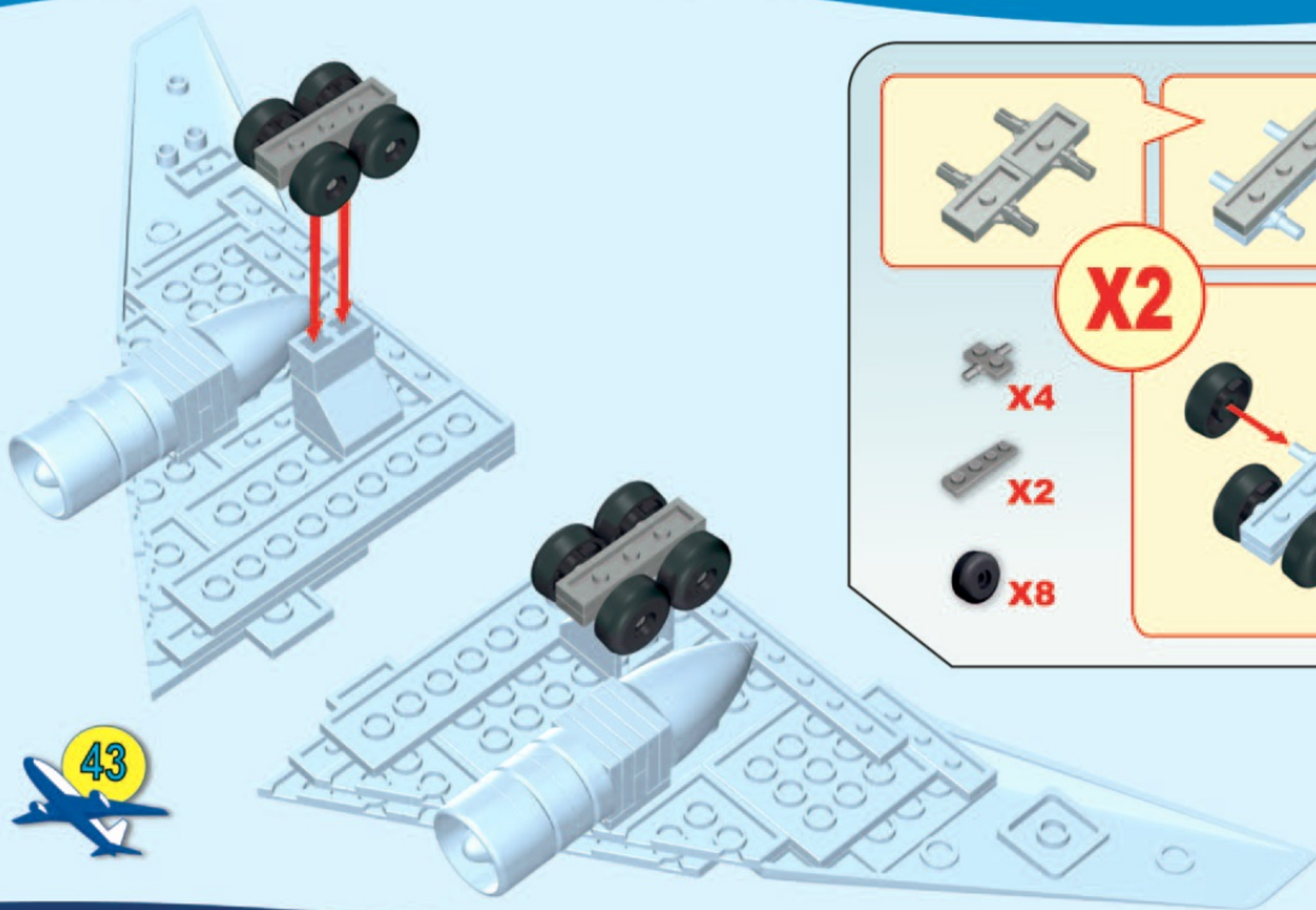

X4

X2

X8

X2

44



45



X1



X1



X2



X1



X2

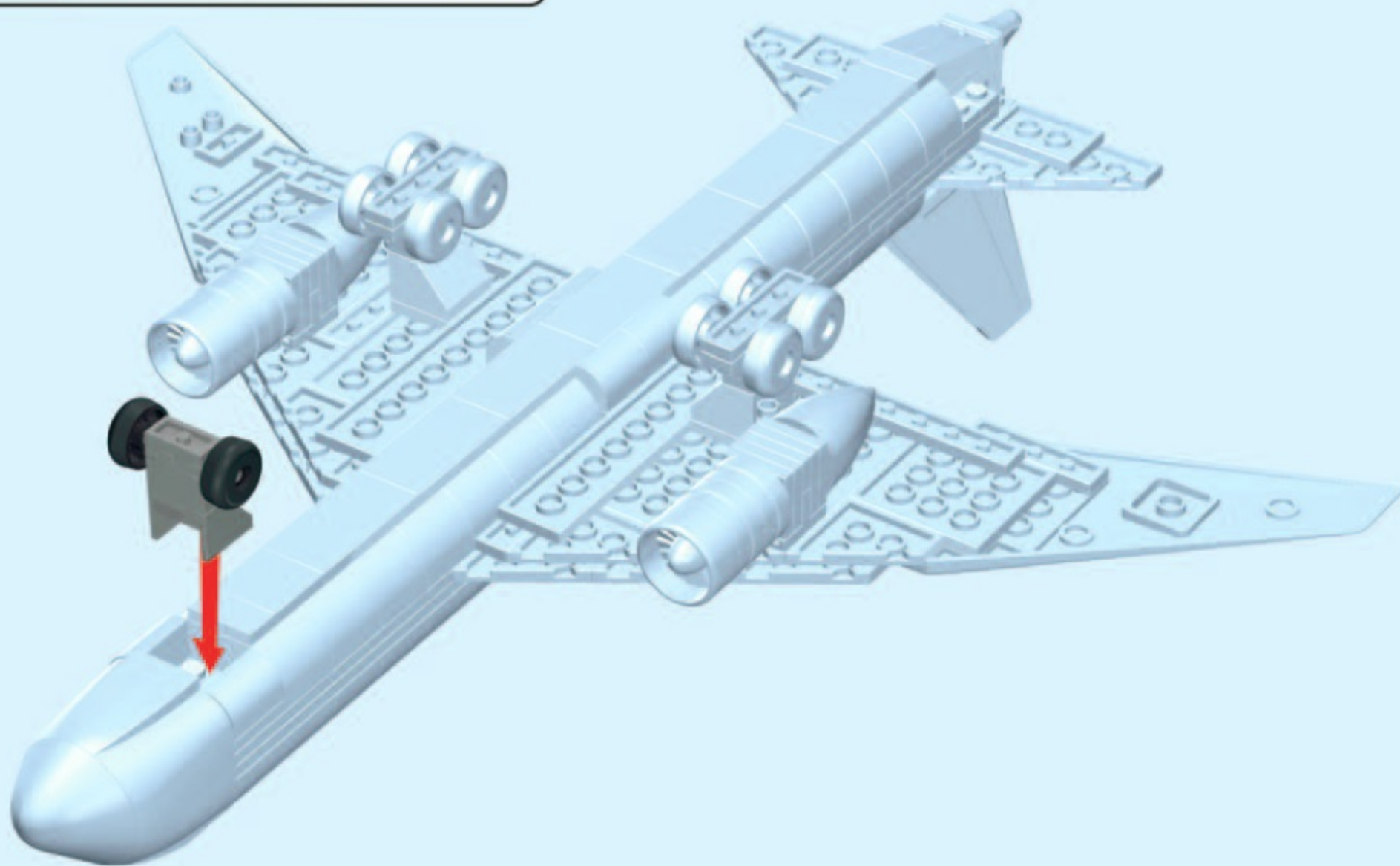
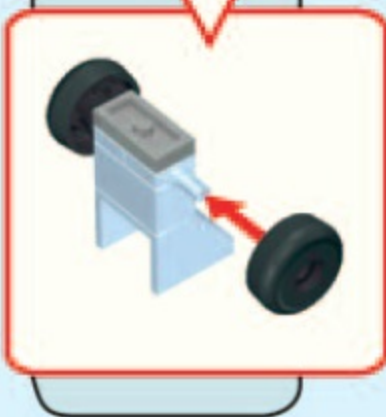
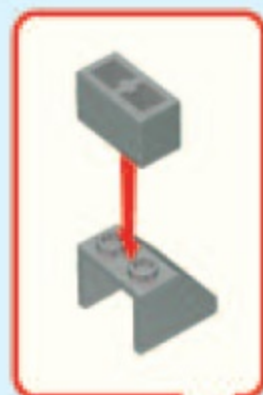

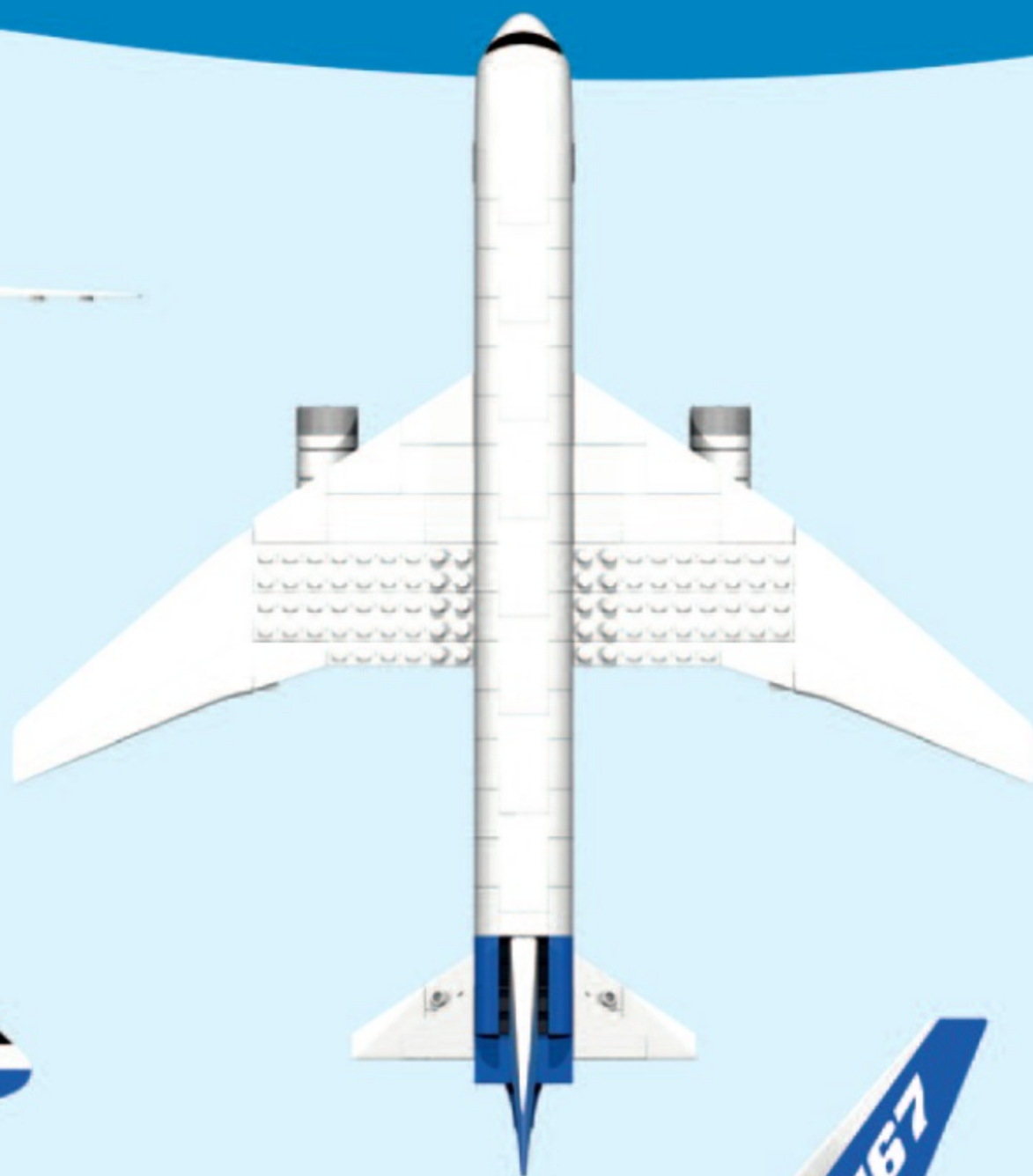

BOEING™



10-26260-256

www.cobi.eu